

Product Summary

BV_{DSS}	R_{DS(ON)}	I_D
100V	0.25Ω	2.1A

Description

This new generation of trench MOSFETs utilizes a unique structure that combines the benefits of low on-resistance with fast switching speed. This makes them ideal for high-efficiency, low-voltage, power-management applications.

Applications

- DC-DC converters
- Power-management functions
- Disconnect switches
- Motor controls

Features

- Low On-Resistance
- Fast Switching Speed
- Low Threshold
- Low Gate Drive
- Low Profile SOIC Package
- **Totally Lead-Free & Fully RoHS Compliant (Notes 1 & 2)**
- **Halogen and Antimony Free. "Green" Device (Note 3)**
- **For automotive applications requiring specific change control (i.e. parts qualified to AEC-Q100/101/104/200, PPAP capable, and manufactured in IATF 16949 certified facilities), please [contact us](mailto:contact@diodes.com) or your local Diodes representative.**
<https://www.diodes.com/quality/product-definitions/>

Mechanical Data

- Package: SO-8
- Package Material: Molded Plastic, "Green" Molding Compound. UL Flammability Classification Rating 94V-0
- Moisture Sensitivity: Level 1 per J-STD-020
- Terminal Connections Indicator: See Diagram
- Terminals: Finish – Matte Tin Annealed over Copper Leadframe. Solderable per MIL-STD-202, Method 208 (E3)
- Weight: 0.076 grams (Approximate)



Top View

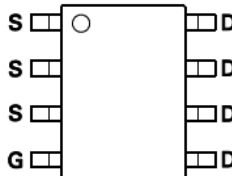

Top View
Pin Configuration

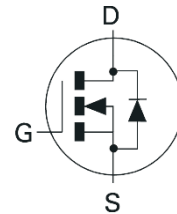

Equivalent Circuit

Ordering Information (Note 4)

Part Number	Package	Reel Size (inches)	Tape Width (mm)	Packing	
				Qty.	Carrier
ZXMN10A08DN8TA	SO-8	7	12	500 units	Reel
ZXMN10A08DN8TC	SO-8	13	12	2,500 units	Reel

- Notes:
1. No purposely added lead. Fully EU Directive 2002/95/EC (RoHS), 2011/65/EU (RoHS 2) & 2015/863/EU (RoHS 3) compliant.
 2. See <https://www.diodes.com/quality/lead-free/> for more information about Diodes Incorporated's definitions of Halogen- and Antimony-free, "Green" and Lead-free.
 3. Halogen- and Antimony-free "Green" products are defined as those which contain <900ppm bromine, <900ppm chlorine (<1500ppm total Br + Cl) and <1000ppm antimony compounds.
 4. For packaging details, go to our website at <https://www.diodes.com/design/support/packaging/diodes-packaging/>.

Marking Information

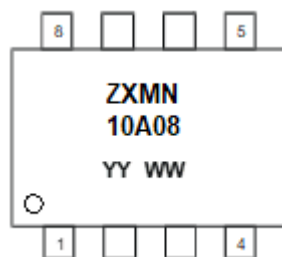

ZXMN10A08 = Product Type Marking Code
 YYWW = Date Code Marking
 YY = Year (ex: 23 = 2023)
 WW = Week (01 to 53)

Absolute Maximum Ratings

Parameter	Symbol	Limit	Unit
Drain-Source Voltage	V _{DSS}	100	V
Gate Source Voltage	V _{GS}	±20	V
Continuous Drain Current	I _D	V _{GS} = 10V, T _A = +25°C (Note 5)	2.1
		V _{GS} = 10V, T _A = +70°C (Note 5)	1.7
		V _{GS} = 10V, T _A = +25°C (Note 6)	1.6
Pulsed Drain Current (Note 7)	I _{DM}	9	A
Continuous Source Current (Body Diode) (Note 5)	I _S	2.6	A
Pulsed Source Current (Body Diode) (Note 7)	I _{SM}	9	A
Power Dissipation at T _A = +25°C (Note 6)	P _D	1.25	W
Linear Derating Factor		10	mW/°C
Power Dissipation at T _A = +25°C (Note 5)	P _D	1.8	W
Linear Derating Factor		14.5	mW/°C
Operating and Storage Temperature Range	T _J , T _{STG}	-55 to +150	°C

Thermal Resistance

Parameter	Symbol	Value	Unit
Junction to Ambient (Note 6)	R _{θJA}	100	°C/W
Junction to Ambient (Note 5)	R _{θJA}	69	°C/W

Electrical Characteristics (@T_A = +25°C, unless otherwise specified.)

Parameter	Symbol	Min	Typ	Max	Unit	Test Condition
STATIC						
Drain-Source Breakdown Voltage	BV _{DSS}	100	—	—	V	I _D = 250μA, V _{GS} = 0V
Zero Gate Voltage Drain Current	I _{DSS}	—	—	0.5	μA	V _{DS} = 100V, V _{GS} = 0V
Gate-Body Leakage	I _{GSS}	—	—	100	nA	V _{GS} = ±20V, V _{DS} = 0V
Gate-Source Threshold Voltage	V _{GS(th)}	2.0	—	—	V	I _D = 250μA, V _{DS} = V _{GS}
Static Drain-Source On-State Resistance (Note 8)	R _{DS(on)}	—	—	0.25	Ω	V _{GS} = 10V, I _D = 3.2A V _{GS} = 6V, I _D = 2.6A
		—	—	0.30		
Forward Transconductance (Notes 8 & 9)	g _{fs}	—	5.0	—	S	V _{DS} = 15V, I _D = 3.2A
DYNAMIC (Note 9)						
Input Capacitance	C _{iss}	—	405	—	pF	V _{DS} = 50V, V _{GS} = 0V f = 1MHz
Output Capacitance	C _{oss}	—	28.2	—	pF	
Reverse Transfer Capacitance	C _{rss}	—	14.2	—	pF	
SWITCHING (Notes 9 & 10)						
Turn-On Delay Time	t _{d(on)}	—	3.4	—	ns	V _{DD} = 30V, I _D = 1.2A R _g ≅ 6.0Ω, V _{GS} = 10V
Rise Time	t _r	—	2.2	—	ns	
Turn-Off Delay Time	t _{d(off)}	—	8	—	ns	
Fall Time	t _f	—	3.2	—	ns	
Gate Charge	Q _g	—	4.2	—	nC	V _{DS} = 50V, V _{GS} = 5V I _D = 1.2A
Total Gate Charge	Q _g	—	7.7	—	nC	V _{DS} = 50V, V _{GS} = 10V I _D = 1.2A
Gate-Source Charge	Q _{gs}	—	1.8	—	nC	
Gate-Drain Charge	Q _{gd}	—	2.1	—	nC	
SOURCE-DRAIN DIODE						
Diode Forward Voltage (Note 8)	V _{SD}	—	0.87	0.95	V	T _J = +25°C, I _S = 3.2A V _{GS} = 0V
Reverse Recovery Time (Note 9)	t _{rr}	—	27	—	ns	T _J = +25°C, I _F = 1.2A dI/dt = 100A/μs
Reverse Recovery Charge (Note 9)	Q _{rr}	—	32	—	nC	

- Notes:
5. For a device surface-mounted on FR4 PCB measured at t ≤ 5 secs.
 6. For a device surface-mounted on 25mm x 25mm FR4 PCB with high coverage of single sided 1oz copper, in still air conditions.
 7. Repetitive rating 25mm x 25mm FR4 PCB, D = 0.02, pulse width 300μs – pulse width limited by maximum junction temperature.
 8. Measured under pulsed conditions. Width = 300μs. Duty cycle ≤ 2%.
 9. For design aid only, not subject to production testing.
 10. Switching characteristics are independent of operating junction temperature.

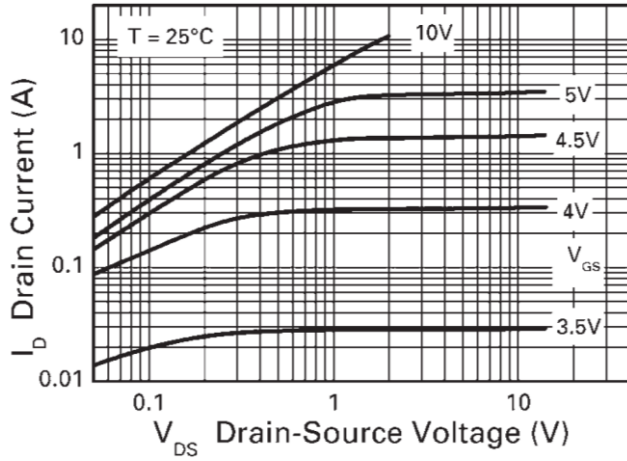

Figure 1. Output Characteristics

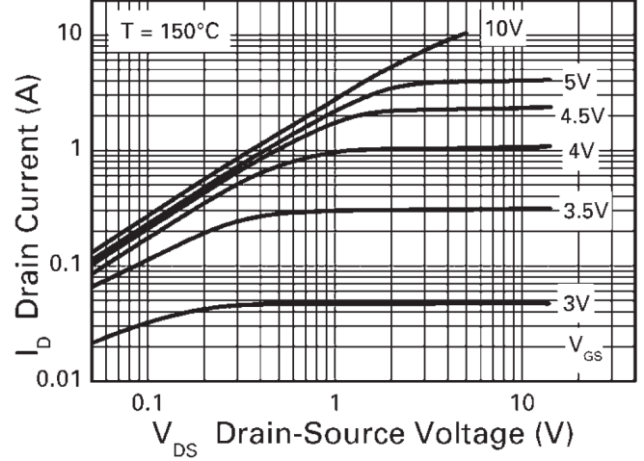

Figure 2. Output Characteristics

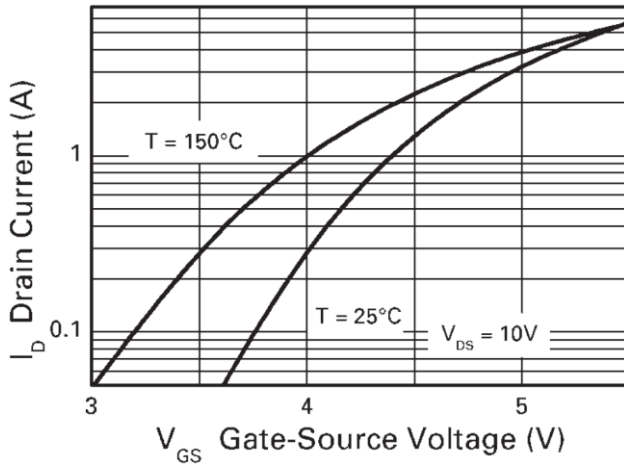

Figure 3. Typical Transfer Characteristics

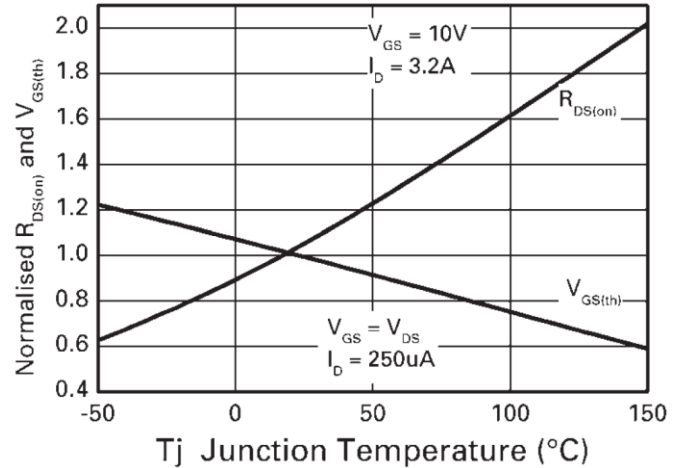

Figure 4. Normalized Curves vs. Temperature

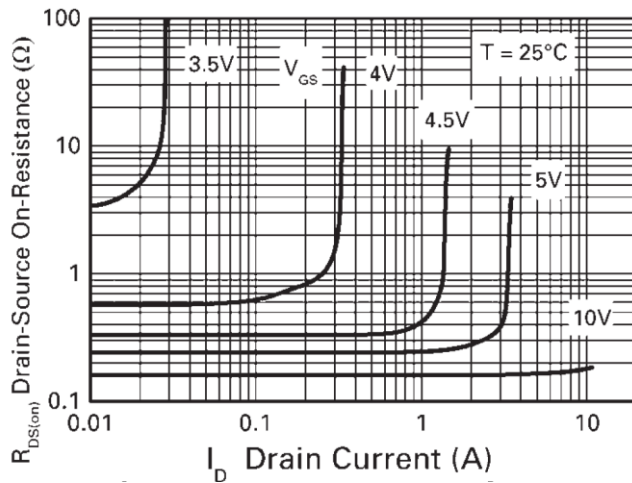

Figure 5. On-Resistance vs. Drain Current

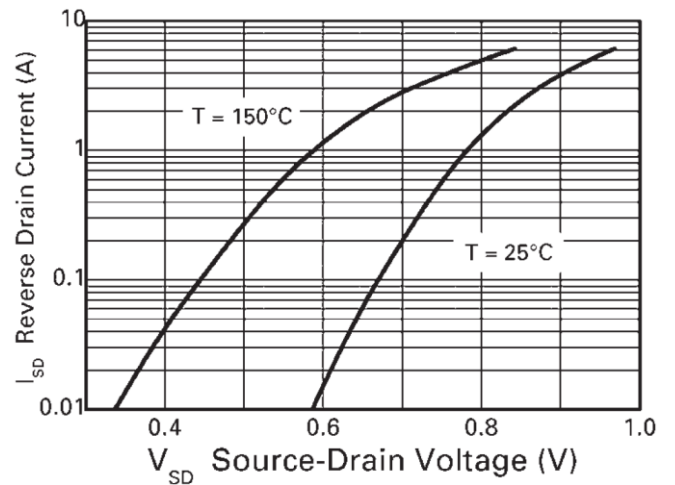

Figure 6. Source-Drain Diode Forward Voltage

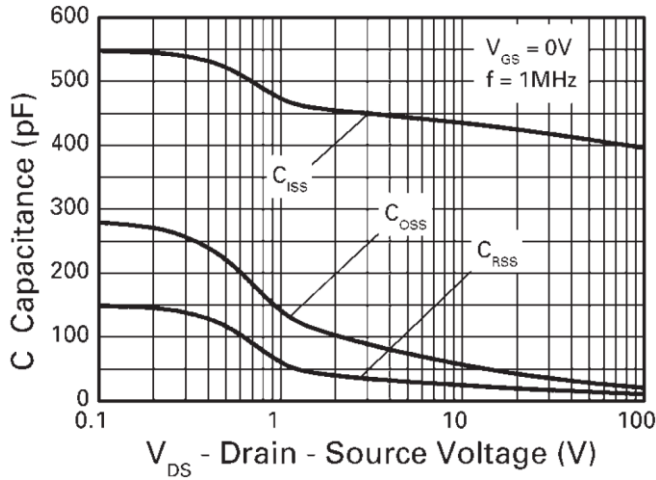

Figure 7. Capacitance vs. Drain-Source Voltage

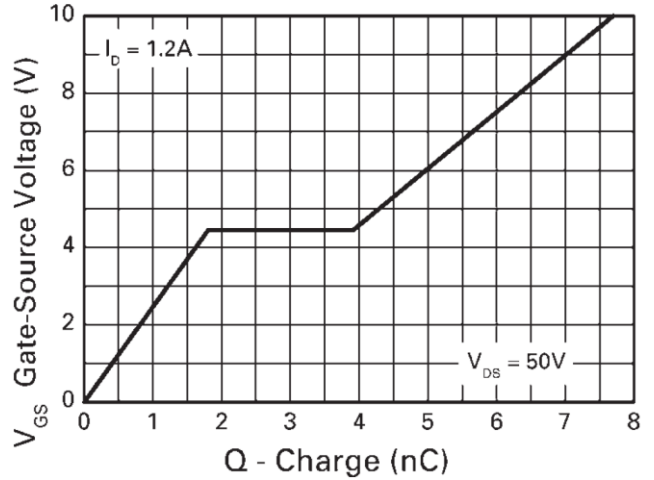

Figure 8. Gate-Source Voltage vs. Gate Charge

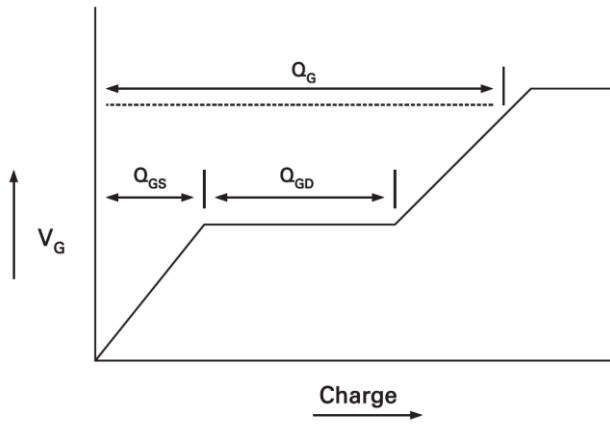

Figure 9. Basic Gate Charge Waveform

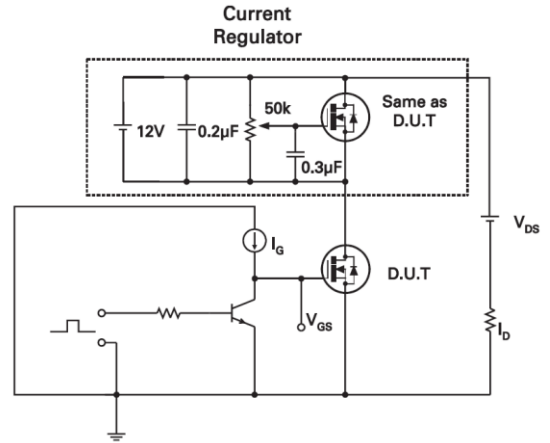

Figure 10. Gate Charge Test Circuit

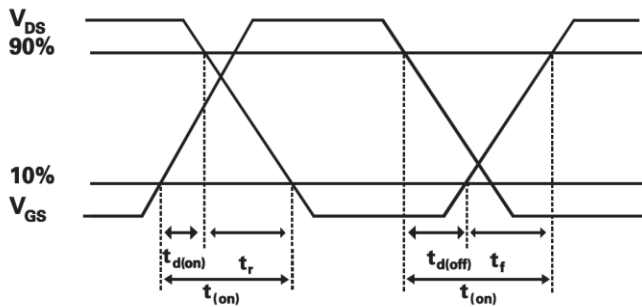

Figure 11. Switching Time Waveforms

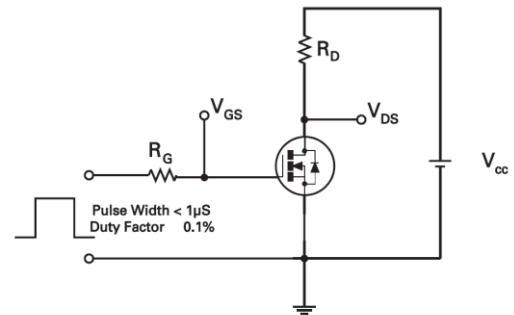
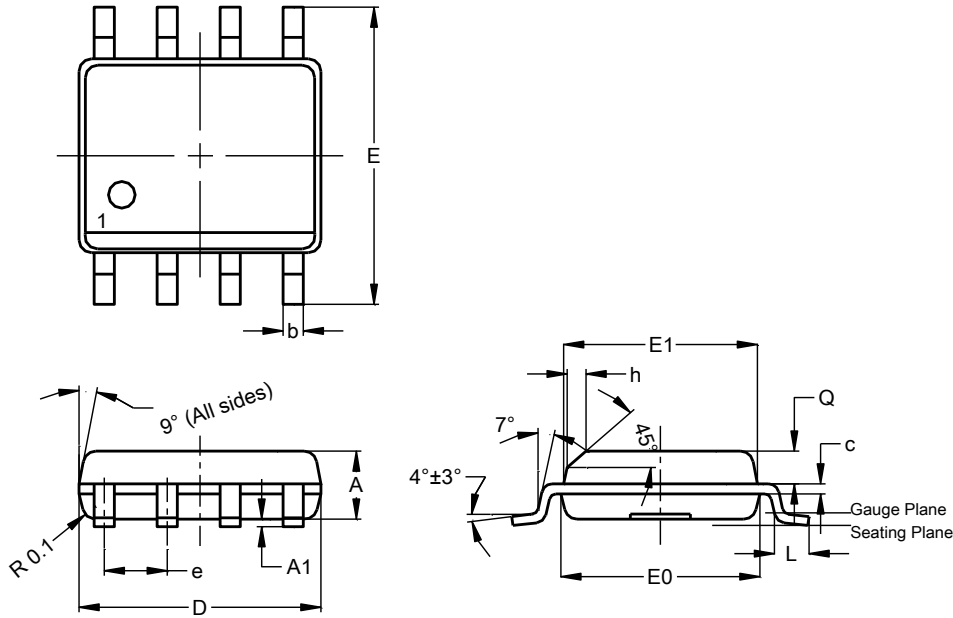

Figure 12. Switching Time Test Circuit

Package Outline Dimensions

Please see <http://www.diodes.com/package-outlines.html> for the latest version.

SO-8



SO-8			
Dim	Min	Max	Typ
A	1.40	1.50	1.45
A1	0.10	0.20	0.15
b	0.30	0.50	0.40
c	0.15	0.25	0.20
D	4.85	4.95	4.90
E	5.90	6.10	6.00
E1	3.80	3.90	3.85
E0	3.85	3.95	3.90
e	--	--	1.27
h	--	--	0.35
L	0.62	0.82	0.72
Q	0.60	0.70	0.65
All Dimensions in mm			

Suggested Pad Layout

Please see <http://www.diodes.com/package-outlines.html> for the latest version.

SO-8

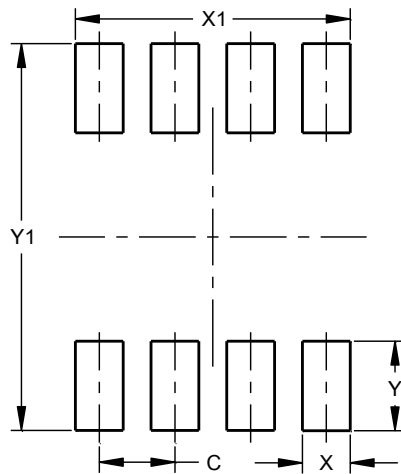

Dimensions	Value (in mm)
C	1.27
X	0.802
X1	4.612
Y	1.505
Y1	6.50

IMPORTANT NOTICE

1. DIODES INCORPORATED (Diodes) AND ITS SUBSIDIARIES MAKE NO WARRANTY OF ANY KIND, EXPRESS OR IMPLIED, WITH REGARDS TO ANY INFORMATION CONTAINED IN THIS DOCUMENT, INCLUDING, BUT NOT LIMITED TO, THE IMPLIED WARRANTIES OF MERCHANTABILITY, FITNESS FOR A PARTICULAR PURPOSE OR NON-INFRINGEMENT OF THIRD PARTY INTELLECTUAL PROPERTY RIGHTS (AND THEIR EQUIVALENTS UNDER THE LAWS OF ANY JURISDICTION).
2. The Information contained herein is for informational purpose only and is provided only to illustrate the operation of Diodes' products described herein and application examples. Diodes does not assume any liability arising out of the application or use of this document or any product described herein. This document is intended for skilled and technically trained engineering customers and users who design with Diodes' products. Diodes' products may be used to facilitate safety-related applications; however, in all instances customers and users are responsible for (a) selecting the appropriate Diodes products for their applications, (b) evaluating the suitability of Diodes' products for their intended applications, (c) ensuring their applications, which incorporate Diodes' products, comply the applicable legal and regulatory requirements as well as safety and functional-safety related standards, and (d) ensuring they design with appropriate safeguards (including testing, validation, quality control techniques, redundancy, malfunction prevention, and appropriate treatment for aging degradation) to minimize the risks associated with their applications.
3. Diodes assumes no liability for any application-related information, support, assistance or feedback that may be provided by Diodes from time to time. Any customer or user of this document or products described herein will assume all risks and liabilities associated with such use, and will hold Diodes and all companies whose products are represented herein or on Diodes' websites, harmless against all damages and liabilities.
4. Products described herein may be covered by one or more United States, international or foreign patents and pending patent applications. Product names and markings noted herein may also be covered by one or more United States, international or foreign trademarks and trademark applications. Diodes does not convey any license under any of its intellectual property rights or the rights of any third parties (including third parties whose products and services may be described in this document or on Diodes' website) under this document.
5. Diodes' products are provided subject to Diodes' Standard Terms and Conditions of Sale (<https://www.diodes.com/about/company/terms-and-conditions/terms-and-conditions-of-sales/>) or other applicable terms. This document does not alter or expand the applicable warranties provided by Diodes. Diodes does not warrant or accept any liability whatsoever in respect of any products purchased through unauthorized sales channel.
6. Diodes' products and technology may not be used for or incorporated into any products or systems whose manufacture, use or sale is prohibited under any applicable laws and regulations. Should customers or users use Diodes' products in contravention of any applicable laws or regulations, or for any unintended or unauthorized application, customers and users will (a) be solely responsible for any damages, losses or penalties arising in connection therewith or as a result thereof, and (b) indemnify and hold Diodes and its representatives and agents harmless against any and all claims, damages, expenses, and attorney fees arising out of, directly or indirectly, any claim relating to any noncompliance with the applicable laws and regulations, as well as any unintended or unauthorized application.
7. While efforts have been made to ensure the information contained in this document is accurate, complete and current, it may contain technical inaccuracies, omissions and typographical errors. Diodes does not warrant that information contained in this document is error-free and Diodes is under no obligation to update or otherwise correct this information. Notwithstanding the foregoing, Diodes reserves the right to make modifications, enhancements, improvements, corrections or other changes without further notice to this document and any product described herein. This document is written in English but may be translated into multiple languages for reference. Only the English version of this document is the final and determinative format released by Diodes.
8. Any unauthorized copying, modification, distribution, transmission, display or other use of this document (or any portion hereof) is prohibited. Diodes assumes no responsibility for any losses incurred by the customers or users or any third parties arising from any such unauthorized use.
9. This Notice may be periodically updated with the most recent version available at <https://www.diodes.com/about/company/terms-and-conditions/important-notice>

The Diodes logo is a registered trademark of Diodes Incorporated in the United States and other countries.
All other trademarks are the property of their respective owners.
© 2023 Diodes Incorporated. All Rights Reserved.

www.diodes.com