

OBSOLETE – PART DISCONTINUED

General Description

The JFET-input operational amplifier family is designed to offer a wider selection than any previously developed operational amplifier family. Each of these JFET-input operational amplifiers incorporates well-matched, high-voltage JFET and bipolar transistors in a monolithic integrated circuit. The devices feature high slew rates, low input bias and offset currents, and low offset-voltage temperature coefficient.

Features

- Low Power Consumption
- Wide Common-Mode and Differential Voltage Ranges
- Low Input Bias and Offset Currents
- Output Short-Circuit Protection
- Low Total Harmonic Distortion...0.003% typ
- High Input Impedance...JFET-Input Stage
- Latch-Up-Free Operation
- High Slew Rate...13V/μs typ
- Common-Mode Input Voltage Range Includes V_{CC+}
- SOP-8L: Available in "Green" Molding Compound (No Br, Sb)
- **Totally Lead-Free & Fully RoHS Compliant (Notes 1 & 2)**
- **Halogen and Antimony Free. "Green" Device (Note 3)**
- **For automotive applications requiring specific change control (i.e. parts qualified to AEC-Q100/101/104/200, PPAP capable, and manufactured in IATF 16949 certified facilities), please [contact us](mailto:contact@diodes.com) or your local Diodes representative. <https://www.diodes.com/quality/product-definitions/>**

Pin Assignments

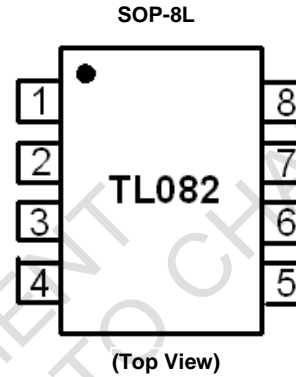

Applications

- Active filters
- Audio pre-amps
- Samples and holds
- Peak detectors

Notes: 1. No purposely added lead. Fully EU Directive 2002/95/EC (RoHS), 2011/65/EU (RoHS 2) & 2015/863/EU (RoHS 3) compliant.
 2. See <https://www.diodes.com/quality/lead-free/> for more information about Diodes Incorporated's definitions of Halogen- and Antimony-free, "Green" and Lead-free.
 3. Halogen- and Antimony-free "Green" products are defined as those which contain <900ppm bromine, <900ppm chlorine (<1500ppm total Br + Cl) and <1000ppm antimony compounds.

Pin Descriptions

Pin Name	Pin No.	Description
OUTPUT1	1	Channel 1 Output
INVERTING INPUT1	2	Channel 1 Inverting Input
NON-INVERTING INPUT1	3	Channel 1 Non-Inverting Input
V_{CC-}	4	Supply Voltage
NON-INVERTING INPUT2	5	Channel 2 Non-inverting Input
INVERTING INPUT2	6	Channel 2 Inverting Input
OUTPUT2	7	Channel 2 Output
V_{CC+}	8	Supply Voltage

Functional Block Diagram

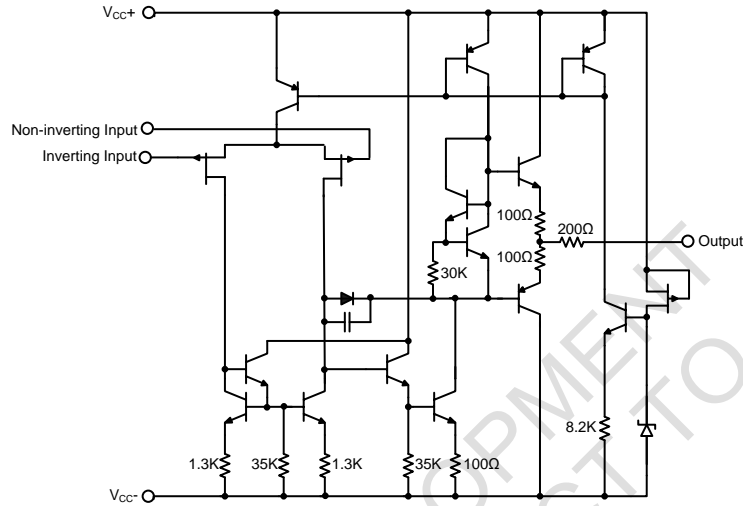

Absolute Maximum Ratings (Note 9)

Symbol	Parameter	Rating	Unit
V _{CC+}	Supply Voltage + (Note 4)	+18	V
V _{CC-}	Supply Voltage - (Note 4)	-18	V
V _I	Input Voltage (Notes 4 and 6)	±15	V
V _{ID}	Differential Input Voltage, V _{ID} (Note 5)	±30	V
—	Duration of Output Short Circuit (Note 7)	Unlimited	—
P _D	Power Dissipation (Note 8)	860	mW
T _J	Operating Junction Temperature Range	+150	°C
T _{ST}	Storage Temperature Range	-65 to +150	°C

Recommended Operating Conditions (Note 9)

Symbol	Description	Rating	Unit
V _{CC±}	Supply Voltage	±15	V
T _A	Operating Ambient Temperature Range	-40 to +85	°C

- Notes:
- All voltage values, except differential voltages, are with respect to the midpoint between V_{CC+} and V_{CC-}.
 - Differential voltage are at the non-inverting input terminal with respect to the inverting input terminal.
 - The magnitude of the input voltage must never exceed the magnitude of the supply voltage or 15V, whichever is less.
 - The output may be shorted to ground or either supply. Temperature and/or supply voltage must be limited to ensure that the dissipation rating is not exceeded.
 - Maximum power dissipation is a function of T_{J(max)}, θ_{JA}, and T_A. The maximum allowable power dissipation at any allowable ambient temperature is P_D = (T_{J(max)} - T_A) / θ_{JA}. Operating at the absolute maximum T_J of +150°C can affect reliability.
 - Absolute Maximum Ratings indicate limits beyond which damage to the device can occur. Recommended Operating Conditions indicate conditions for which the device is intended to be functional, but specific performance is not guaranteed. For guaranteed specifications and the test conditions, see the Electrical Characteristics.

Electrical Characteristics (@ $V_{CC\pm} = \pm 15V$, $T_A = +25^\circ C$, unless otherwise specified.)

Symbol	Parameter	Test Conditions	Min	Typ.	Max	Unit	
V_{IO}	Input Offset Voltage	$V_O = 0$, $R_S = 50\Omega$	$T_A = +25^\circ C$	—	3	6	mV
			$T_A = \text{full range}$	—	—	9	
$^{\circ}V_{IO}$	Temperature Coefficient of Input Offset Voltage	$V_O = 0$, $R_S = 50\Omega$, $T_A = \text{full range}$	—	—	—	$\mu V/^\circ C$	
I_{IO}	Input Offset Current	$V_O = 0$	$T_A = +25^\circ C$	—	5	100	pA
			$T_A = \text{full range}$	—	—	10	nA
I_{IB}	Input Bias Current	$V_O = 0$	$T_A = +25^\circ C$	—	30	200	pA
			$T_A = \text{full range}$	—	—	20	nA
V_{ICR}	Common Mode Input Voltage Range	—	± 11	-12 to +15	—	V	
V_{OM}	Maximum Peak Output Voltage Swing	$R_L = 10k\Omega$, $T_A = +25^\circ C$	± 12	± 13.5	—	V	
		$R_L \geq 10k\Omega$	± 12	—	—		
		$R_L \geq 2k\Omega$	$T_A = \text{full range}$	± 10	—		—
A_{VD}	Large Signal Differential Voltage Amplification	$V_O = \pm 10V$, $R_L \geq 2k\Omega$	$T_A = +25^\circ C$	50	—	—	V/mV
			$T_A = \text{full range}$	25	—	—	
B_1	Unity Gain Bandwidth	—	—	3	—	MHz	
r_i	Input Resistance	$T_A = +25^\circ C$	—	10^{12}	—	Ω	
CMRR	Common Mode Rejection Ratio	$V_{IC} = V_{ICRmin}$, $V_O = 0$ $R_S = 50\Omega$, $T_A = +25^\circ C$	75	86	—	dB	
k_{SVR}	Supply Voltage Rejection Ratio ($\Delta V_{CC\pm}/\Delta V_{IO}$)	$V_{CC} = \pm 9$ to $\pm 15V$ $V_O = 0$ $R_S = 50\Omega$, $T_A = +25^\circ C$	80	86	—	dB	
I_{CC}	Supply Current (each amplifier)	$V_O = 0$, $T_A = +25^\circ C$ No load	—	1.4	2.8	mA	
V_{O1}/V_{O2}	Crosstalk Attenuation	$A_{VD} = 100$, $T_A = +25^\circ C$	—	120	—	dB	
SR	Slew Rate at Unity Gain	$V_I = 10V$, $C_L = 100pF$, $R_L = 2k\Omega$ (See Figure 1)	$T_A = +25^\circ C$	8	—	—	V/ μs
			$T_A = \text{full range}$	5	—	—	
t_r	Rise Time	$V_I = 20mV$, $R_L = 2k\Omega$, $C_L = 100pF$ (See Figure 1)	—	0.05	—	μs	
—	Overshoot Factor	(See Figure 1)	—	20	—	%	
V_n	Equivalent Input Noise Voltage	$R_S = 20\Omega$	—	—	—	nV/\sqrt{Hz}	
			—	—	—	μV	
I_n	Equivalent Input Noise Current	$R_S = 20\Omega$, $f = 1kHz$	—	0.01	—	pA/\sqrt{Hz}	
THD	Total Harmonic Distortion	$V_{Rms} = 6V$, $A_{VD} = 1$, $R_L \geq 2k\Omega$, $R_S \leq 1k\Omega$, $f = 1kHz$	—	0.003	—	%	
θ_{JA}	Thermal Resistance Junction-to-Ambient	SOP-8L (Note 10)	—	145	—	$^\circ C/W$	
θ_{JC}	Thermal Resistance Junction-to-Case	SOP-8L (Note 10)	—	35	—	$^\circ C/W$	

Note: 10. Test condition for SOP-8L: Devices mounted on FR-4 substrate PC board, with minimum recommended pad layout.

OBSOLETE - PART DISCONTINUED

Typical Performance Characteristics

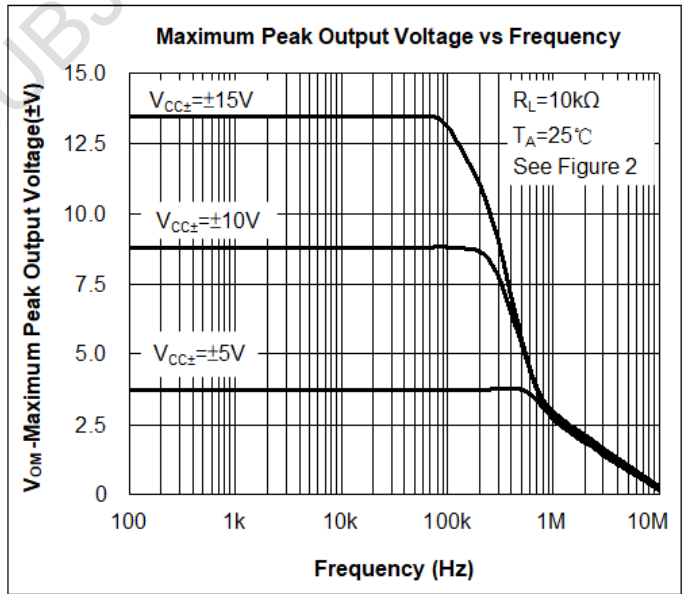
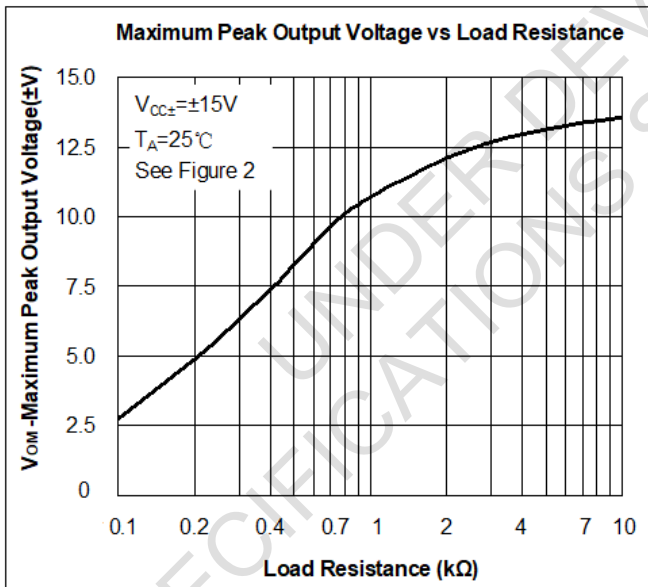
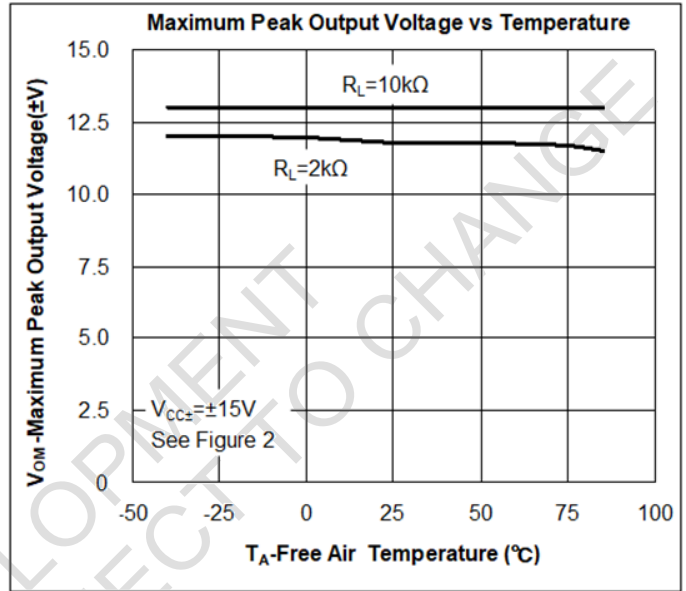
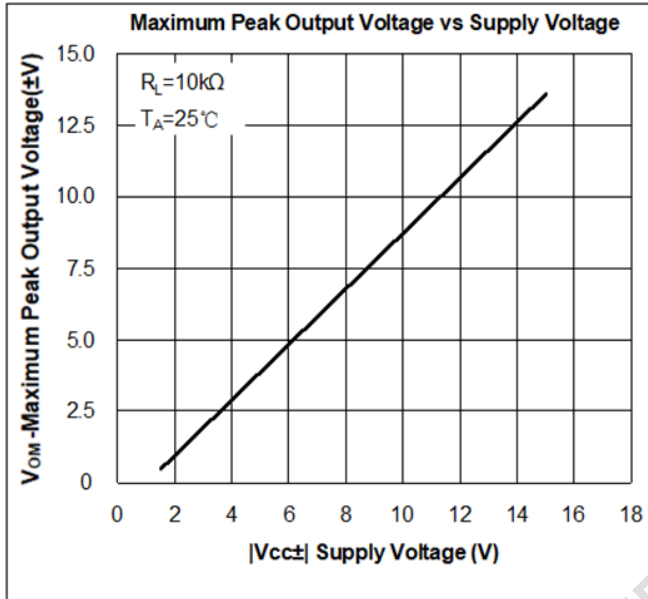

OBSOLETE - PART DISCONTINUED

Typical Performance Characteristics (continued)

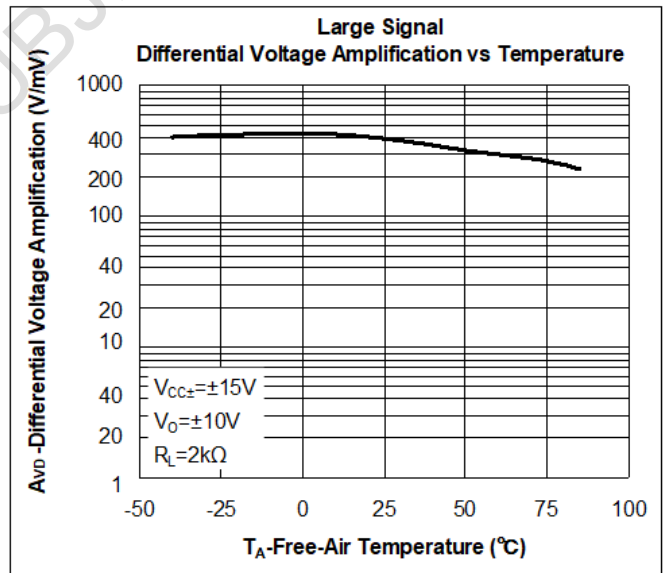
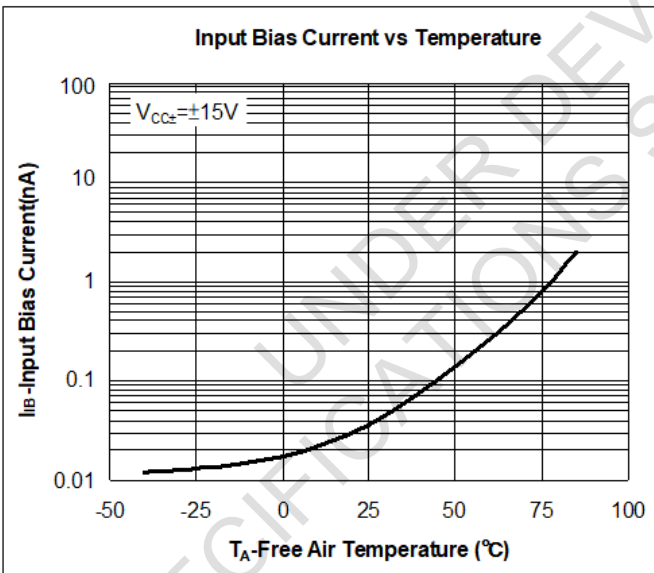
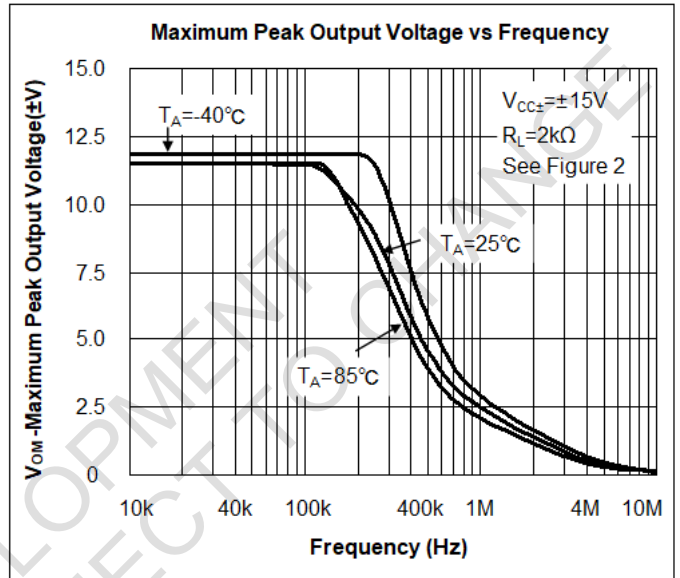
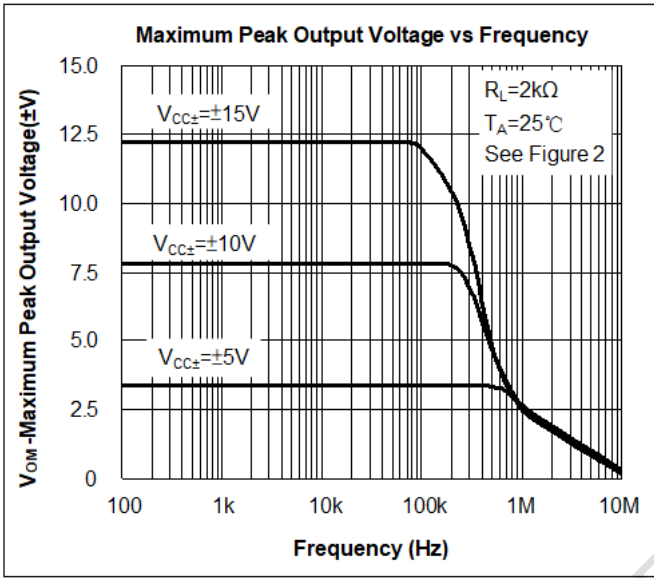

OBSOLETE - PART DISCONTINUED

Typical Performance Characteristics (continued)

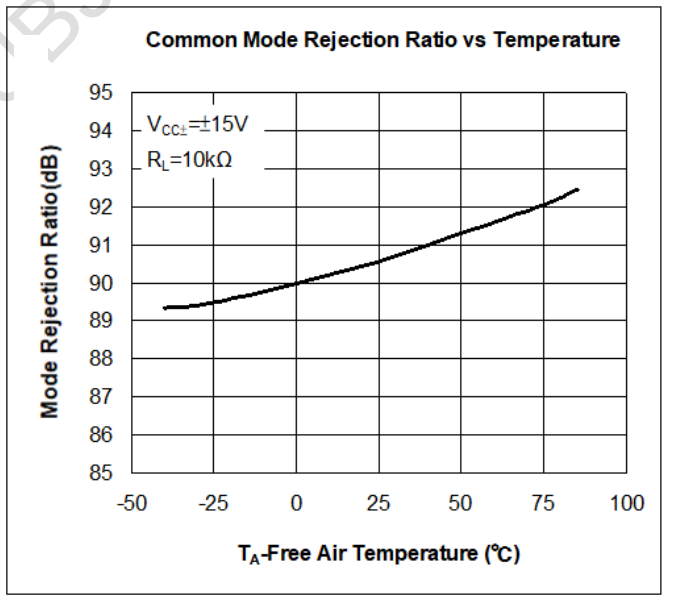
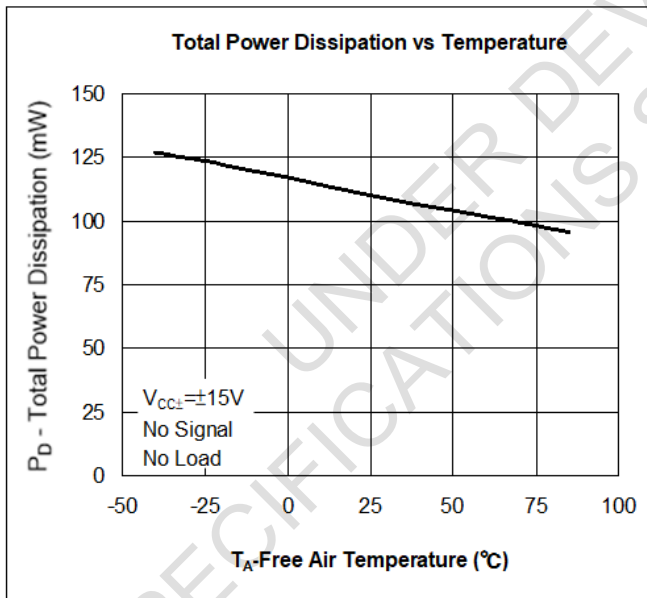
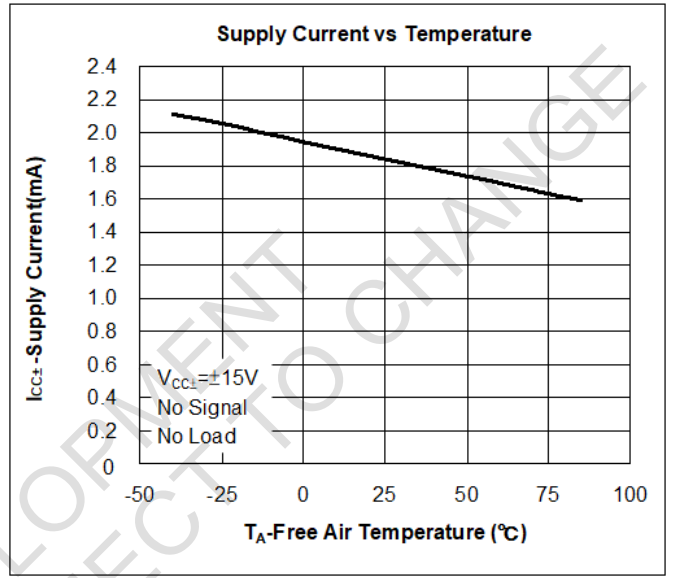
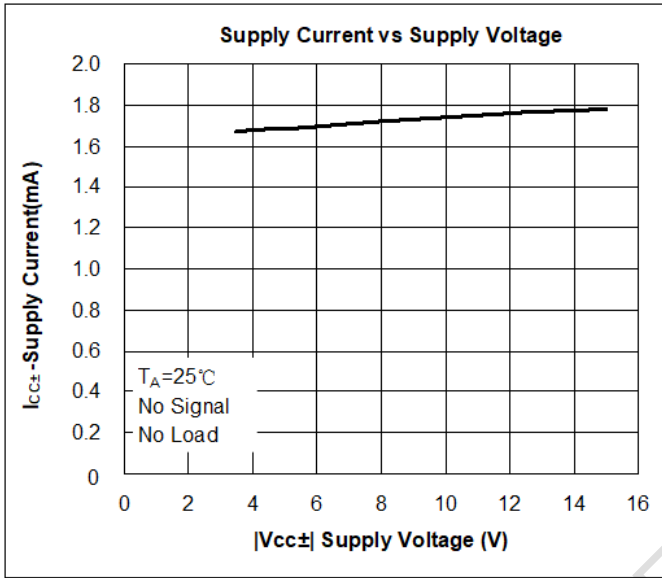

OBSOLETE - PART DISCONTINUED

Typical Performance Characteristics (continued)

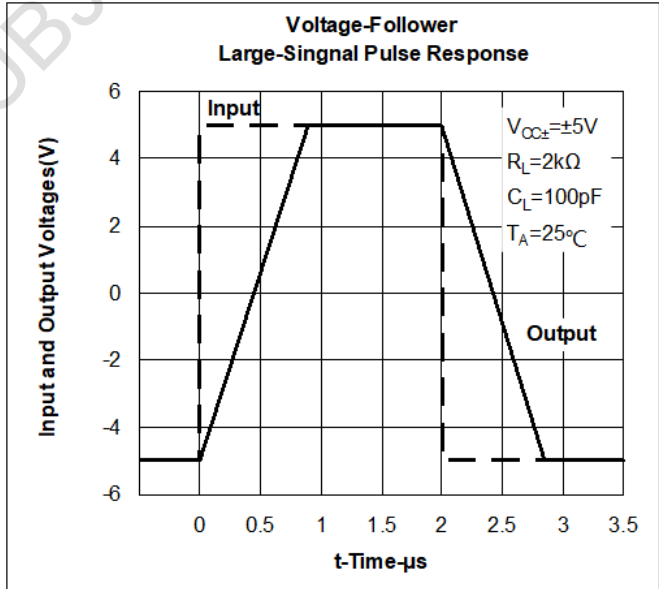
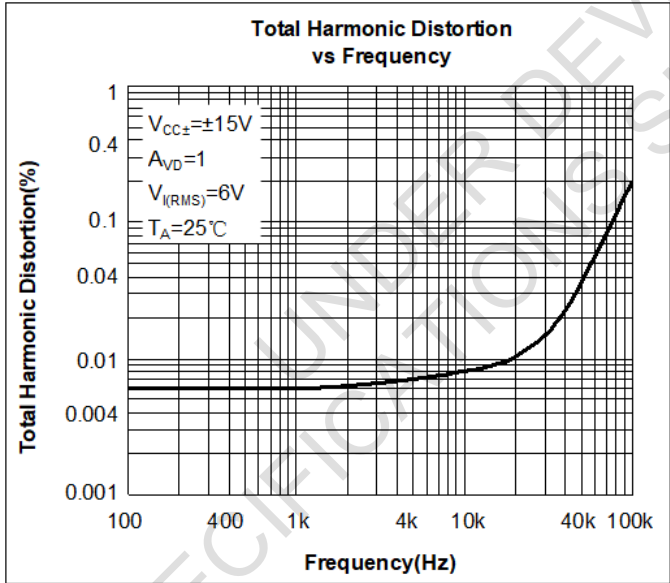
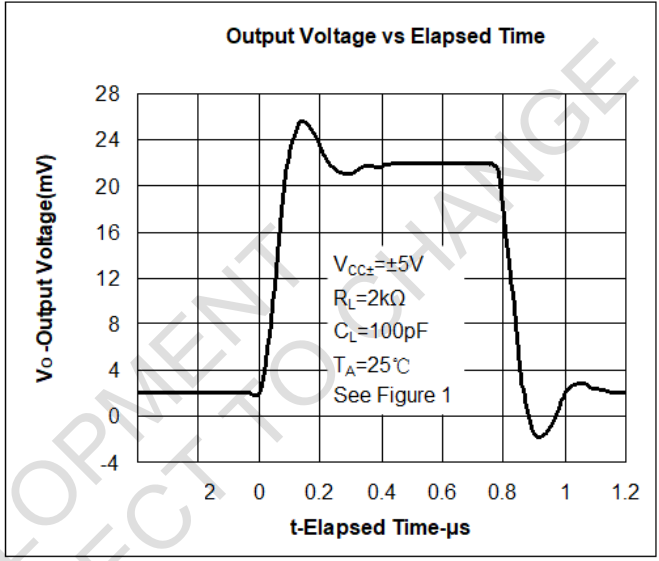
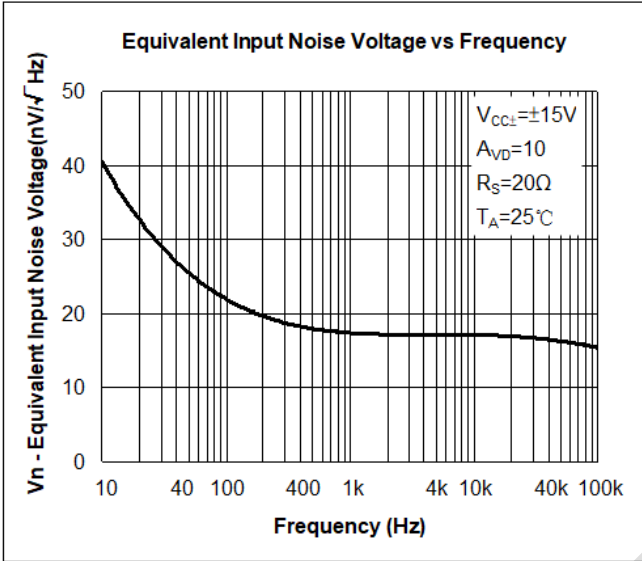

Test Circuit

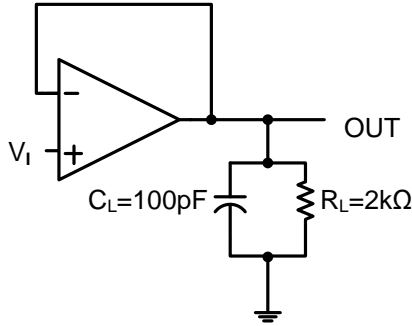

Figure 1. Unity-Gain Amplifier

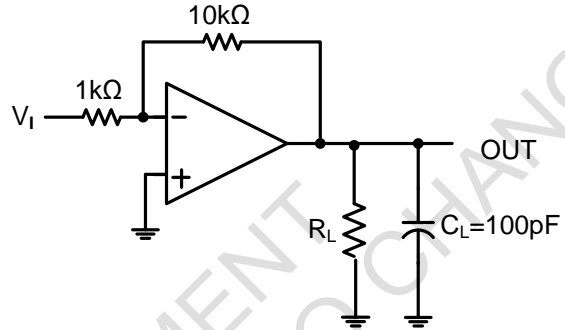
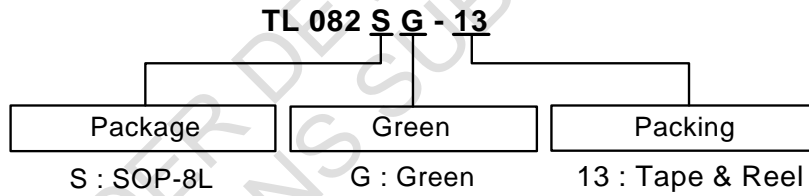

Figure 2. Gain-of-10 Inverting Amplifier

Ordering Information



Part Number	Package Code	Package (Note 11)	Packing	
			Qty.	Carrier
TL082SG-13	S	SOP-8L	2500	13" Tape and Reel

Note: 11. For packaging details, go to our website at <https://www.diodes.com/design/support/packaging/diodes-packaging/>.

Marking Information

SOP-8L

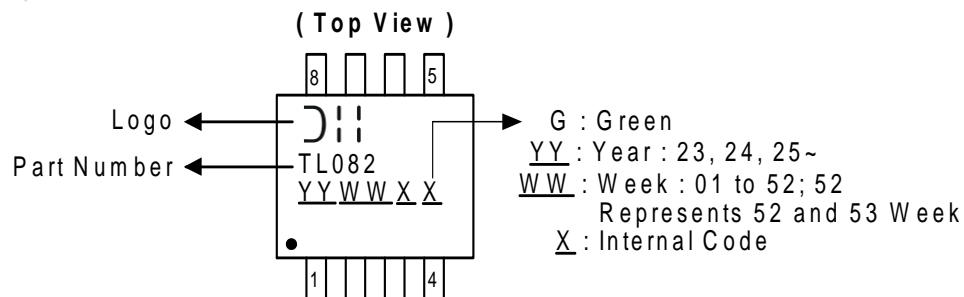

Package Outline Dimensions (All Dimensions in mm)

Please see <http://www.diodes.com/package-outlines.html> for the latest version.

SOP-8L

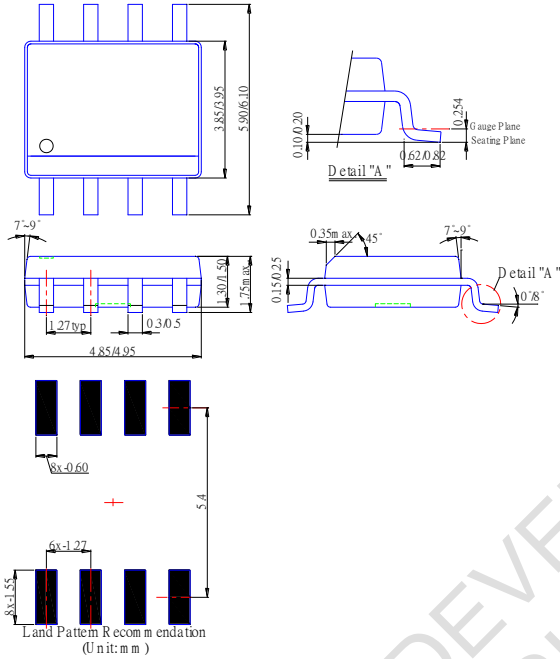

OBSOLETE - PART DISCONTINUED

UNDER DEVELOPMENT SUBJECT TO CHANGE

IMPORTANT NOTICE

1. DIODES INCORPORATED (Diodes) AND ITS SUBSIDIARIES MAKE NO WARRANTY OF ANY KIND, EXPRESS OR IMPLIED, WITH REGARDS TO ANY INFORMATION CONTAINED IN THIS DOCUMENT, INCLUDING, BUT NOT LIMITED TO, THE IMPLIED WARRANTIES OF MERCHANTABILITY, FITNESS FOR A PARTICULAR PURPOSE OR NON-INFRINGEMENT OF THIRD PARTY INTELLECTUAL PROPERTY RIGHTS (AND THEIR EQUIVALENTS UNDER THE LAWS OF ANY JURISDICTION).
2. The Information contained herein is for informational purpose only and is provided only to illustrate the operation of Diodes' products described herein and application examples. Diodes does not assume any liability arising out of the application or use of this document or any product described herein. This document is intended for skilled and technically trained engineering customers and users who design with Diodes' products. Diodes' products may be used to facilitate safety-related applications; however, in all instances customers and users are responsible for (a) selecting the appropriate Diodes products for their applications, (b) evaluating the suitability of Diodes' products for their intended applications, (c) ensuring their applications, which incorporate Diodes' products, comply the applicable legal and regulatory requirements as well as safety and functional-safety related standards, and (d) ensuring they design with appropriate safeguards (including testing, validation, quality control techniques, redundancy, malfunction prevention, and appropriate treatment for aging degradation) to minimize the risks associated with their applications.
3. Diodes assumes no liability for any application-related information, support, assistance or feedback that may be provided by Diodes from time to time. Any customer or user of this document or products described herein will assume all risks and liabilities associated with such use, and will hold Diodes and all companies whose products are represented herein or on Diodes' websites, harmless against all damages and liabilities.
4. Products described herein may be covered by one or more United States, international or foreign patents and pending patent applications. Product names and markings noted herein may also be covered by one or more United States, international or foreign trademarks and trademark applications. Diodes does not convey any license under any of its intellectual property rights or the rights of any third parties (including third parties whose products and services may be described in this document or on Diodes' website) under this document.
5. Diodes' products are provided subject to Diodes' Standard Terms and Conditions of Sale (<https://www.diodes.com/about/company/terms-and-conditions/terms-and-conditions-of-sales/>) or other applicable terms. This document does not alter or expand the applicable warranties provided by Diodes. Diodes does not warrant or accept any liability whatsoever in respect of any products purchased through unauthorized sales channel.
6. Diodes' products and technology may not be used for or incorporated into any products or systems whose manufacture, use or sale is prohibited under any applicable laws and regulations. Should customers or users use Diodes' products in contravention of any applicable laws or regulations, or for any unintended or unauthorized application, customers and users will (a) be solely responsible for any damages, losses or penalties arising in connection therewith or as a result thereof, and (b) indemnify and hold Diodes and its representatives and agents harmless against any and all claims, damages, expenses, and attorney fees arising out of, directly or indirectly, any claim relating to any noncompliance with the applicable laws and regulations, as well as any unintended or unauthorized application.
7. While efforts have been made to ensure the information contained in this document is accurate, complete and current, it may contain technical inaccuracies, omissions and typographical errors. Diodes does not warrant that information contained in this document is error-free and Diodes is under no obligation to update or otherwise correct this information. Notwithstanding the foregoing, Diodes reserves the right to make modifications, enhancements, improvements, corrections or other changes without further notice to this document and any product described herein. This document is written in English but may be translated into multiple languages for reference. Only the English version of this document is the final and determinative format released by Diodes.
8. Any unauthorized copying, modification, distribution, transmission, display or other use of this document (or any portion hereof) is prohibited. Diodes assumes no responsibility for any losses incurred by the customers or users or any third parties arising from any such unauthorized use.
9. This Notice may be periodically updated with the most recent version available at <https://www.diodes.com/about/company/terms-and-conditions/important-notice>

The Diodes logo is a registered trademark of Diodes Incorporated in the United States and other countries.
All other trademarks are the property of their respective owners.
© 2023 Diodes Incorporated. All Rights Reserved.

www.diodes.com