

Features

- $BV_{CEO} > -100V$
- $BV_{EBO} > -8V$
- Continuous Current I_C to $-2.5A$
- Peak Pulse Current I_{CM} to $-8A$
- Ultra-Low Saturation Voltage $V_{CE(sat)} < -85mV @ -1A$
- High Current $R_{CE(sat)} = 60m\Omega$ Typical
- Small Form Factor Thermally Efficient Package Enables Higher Density End Products
- Wettable Flank for Improved Optical Inspection
- Rated to $+175^\circ C$ – Ideal for High-Temperature Environments
- Complementary NPN Type: [DXTN78100CFG](#)
- **Lead-Free Finish; RoHS Compliant (Notes 1 & 2)**
- **Halogen and Antimony Free. "Green" Device (Note 3)**
- **An automotive-compliant part is available under a separate datasheet ([DXTP78100CFGQ](#))**

Mechanical Data

- Package: PowerDI[®]3333-8
- Package Material: Molded Plastic. "Green" Molding Compound. UL Flammability Rating 94V-0
- Moisture Sensitivity: Level 1 per J-STD-020
- Terminals: Finish - Matte Tin. Solderable per MIL-STD-202, Method 208 (E3)
- Weight: 0.03 grams (Approximate)

Applications

- MOSFET & IGBT gate drivers
- Load switches
- Low-voltage regulation
- DC to DC converters
- Motors, solenoids, relays and actuator drivers control

PowerDI3333-8/SWP (Type UX)

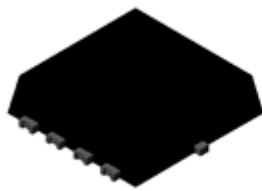

Top View

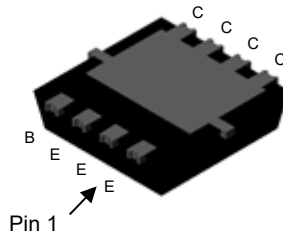

Bottom View

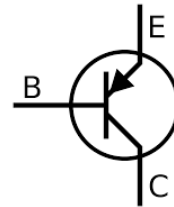

Device Symbol

Ordering Information (Note 4)

Orderable Part Number	Package	Marking	Reel Size (inches)	Tape Width (mm)	Packing	
					Qty.	Carrier
DXTP78100CFG-7	PowerDI3333-8/SWP (Type UX)	2X5	7	12	2,000	Reel

- Notes:
1. EU Directive 2002/95/EC (RoHS), 2011/65/EU (RoHS 2) & 2015/863/EU (RoHS 3) compliant. All applicable RoHS exemptions applied.
 2. See <https://www.diodes.com/quality/lead-free/> for more information about Diodes Incorporated's definitions of Halogen- and Antimony-free, "Green" and Lead-free.
 3. Halogen- and Antimony-free "Green" products are defined as those which contain <900ppm bromine, <900ppm chlorine (<1500ppm total Br + Cl) and <1000ppm antimony compounds.
 4. For packaging details, go to our website at <https://www.diodes.com/design/support/packaging/diodes-packaging/>.

Marking Information

PowerDI3333-8/SWP (Type UX)

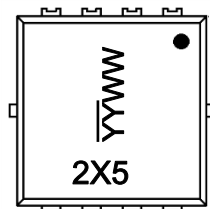

2X5 = Product Type Marking Code
 YYWW = Date Code Marking
 YY = Last Two Digits of Year (ex: 25 = 2025)
 WW = Week Code (01 to 53)

PowerDI is a registered trademark of Diodes Incorporated in the United States and other countries.

Absolute Maximum Ratings (@T_A = +25°C, unless otherwise specified.)

Characteristic	Symbol	Value	Unit
Collector-Base Voltage	V _{CBO}	-110	V
Collector-Emitter Voltage	V _{CEO}	-100	V
Emitter-Base Voltage	V _{EBO}	-8	V
Continuous Collector Current (Note 5)	I _C	-1.5	A
Continuous Collector Current (Note 7)	I _C	-2.5	A
Peak Pulse Current	I _{CM}	-8	A

Thermal Characteristics (@T_A = +25°C, unless otherwise specified.)

Characteristic	Symbol	Value	Unit	
Power Dissipation	P _D	(Note 5)	900	mW
		(Note 6)	1.6	W
		(Note 7)	2.4	W
Thermal Resistance, Junction to Ambient	R _{θJA}	(Note 5)	140	°C/W
		(Note 6)	92	°C/W
		(Note 7)	62.5	°C/W
Thermal Resistance, Junction to Case (Note 7)	R _{θJC}	8	°C/W	
Thermal Resistance, Junction to Lead (Note 8)	R _{θJL}	6.5	°C/W	
Operating and Storage Temperature Range	T _J , T _{STG}	-55 to +175	°C	

ESD Ratings (Note 9)

Characteristic	Symbol	Value	Unit	JEDEC Class
Electrostatic Discharge - Human Body Model	ESD HBM	4,000	V	3A
Electrostatic Discharge - Machine Model	ESD MM	400	V	C
Electrostatic Discharge - Charged Device Model	ESD CDM	1,000	V	IV

- Notes:
5. For a device mounted with the collector tab on MRP FR4-PCB; device is measured under still air conditions whilst operating in a steady state.
 6. Same as Note 5, except the device is mounted on 15mm x 15mm 2oz copper.
 7. Same as Note 5, except the device is mounted on 25mm x 25mm 2oz copper.
 8. Thermal resistance from junction to solder-point (at the collector tab).
 9. Refer to JEDEC specifications JESD22-A114, JESD22-A115 and JESD22-C101.

Thermal Characteristics and Derating Information

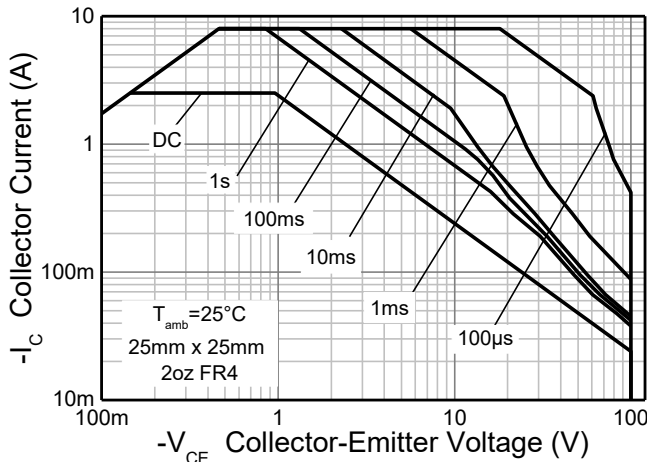

Fig 1. Safe Operating Area

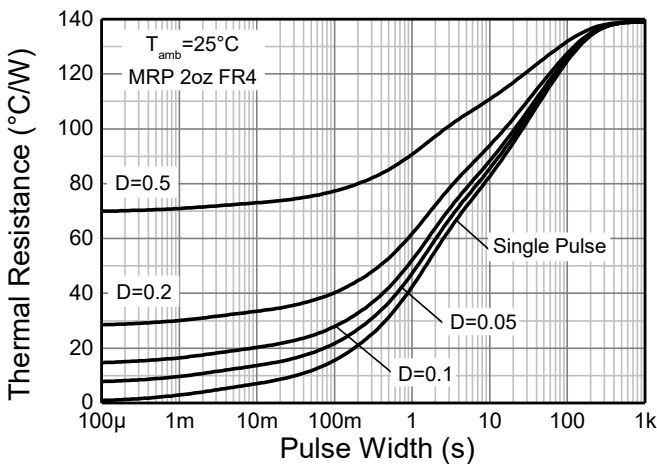

Fig 2. Transient Thermal Impedance

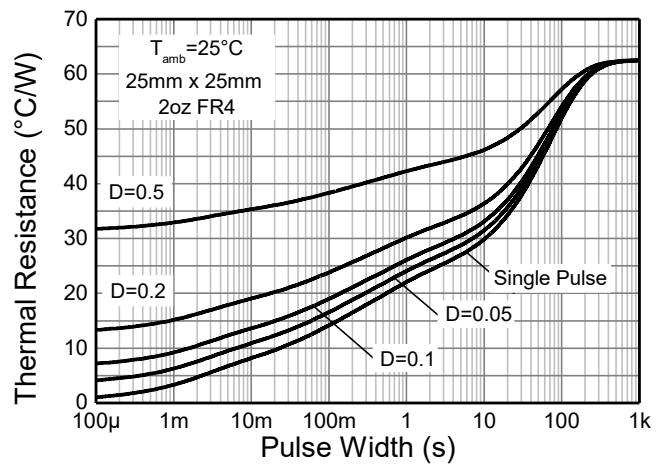

Fig 3. Transient Thermal Impedance

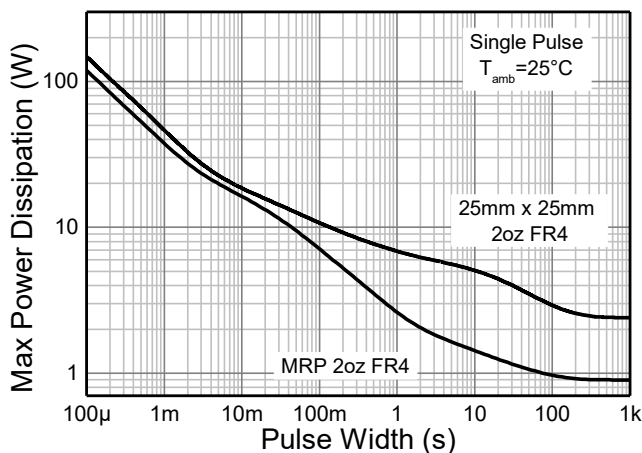

Fig 4. Pulse Power Dissipation

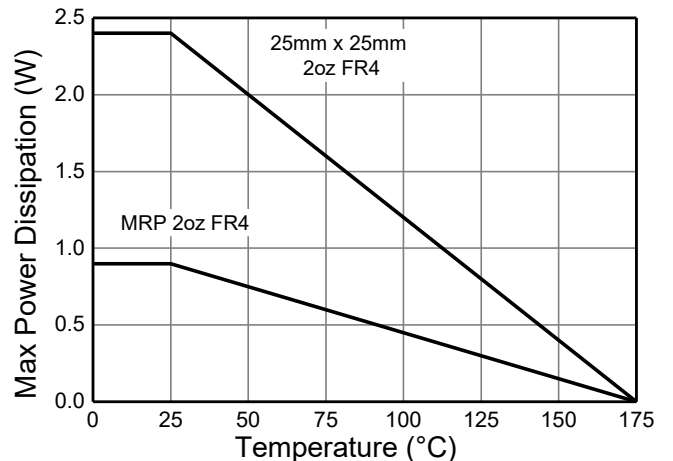

Fig 5. Derating Curve

Electrical Characteristics (@T_A = +25°C, unless otherwise specified.)

Characteristic	Symbol	Min	Typ	Max	Unit	Test Condition
Collector-Base Breakdown Voltage	BV _{CBO}	-110	—	—	V	I _C = -100μA
Collector-Emitter Breakdown Voltage (Note 10)	BV _{CEO}	-100	—	—	V	I _C = -10mA
Emitter-Collector Breakdown Voltage	BV _{ECO}	-5	—	—	V	I _E = -100μA
Emitter-Base Breakdown Voltage	BV _{EBO}	-8	—	—	V	I _E = -100μA
Collector Cutoff Current	I _{CBO}	—	—	-100	nA	V _{CB} = -110V
		—	—	1	μA	V _{CB} = -110V, T _A = +125°C
Collector Cutoff Current	I _{CES}	—	—	-300	nA	V _{CE} = -80V
Emitter Cutoff Current	I _{EBO}	—	—	-50	nA	V _{EB} = -7V
Collector-Emitter Saturation Voltage (Note 10)	V _{CE(sat)}	—	-90	—	mV	I _C = -100mA, I _B = -1mA
		—	-110	-160	mV	I _C = -1A, I _B = -50mA
		—	-70	-85	mV	I _C = -1A, I _B = -100mA
		—	-90	-125	mV	I _C = -1.5A, I _B = -150mA
		—	-165	-300	mV	I _C = -2.5A, I _B = -250mA
Base-Emitter Saturation Voltage (Note 10)	V _{BE(sat)}	—	-860	-950	mV	I _C = -1.5A, I _B = -150mA
		—	-930	-1,050	mV	I _C = -2.5A, I _B = -250mA
Base-Emitter Turn-On Voltage (Note 10)	V _{BE(on)}	—	-750	-850	mV	I _C = -1.5A, V _{CE} = -2V
		—	-815	-900	mV	I _C = -2.5A, V _{CE} = -2V
DC Current Gain (Note 10)	h _{FE}	200	350	—	—	I _C = -10mA, V _{CE} = -2V
		250	340	420	—	I _C = -100mA, V _{CE} = -2V
		220	300	—	—	I _C = -0.5A, V _{CE} = -2V
		160	260	—	—	I _C = -1A, V _{CE} = -2V
		60	130	—	—	I _C = -1.5A, V _{CE} = -2V
		15	35	—	—	I _C = -2.5A, V _{CE} = -2V
Input Capacitance	C _{ibo}	—	300	—	pF	V _{EB} = 0.5V, f = 1MHz
Output Capacitance	C _{obo}	—	21	—	pF	V _{CB} = 10V, f = 1MHz
Current Gain-Bandwidth Product	f _T	150	290	—	MHz	V _{CE} = -10V, I _C = -100mA f = 50MHz
Turn-On Time	t _d	—	13.5	—	ns	V _{CC} = -10V, I _C = -1.5A I _{B1} = -I _{B2} = -150mA
	t _r	—	90	—	ns	
Turn-Off Time	t _s	—	255	—	ns	
	t _f	—	48	—	ns	

Note: 10. Measured under pulsed conditions. Pulse width ≤ 300μs. Duty cycle ≤ 2%.

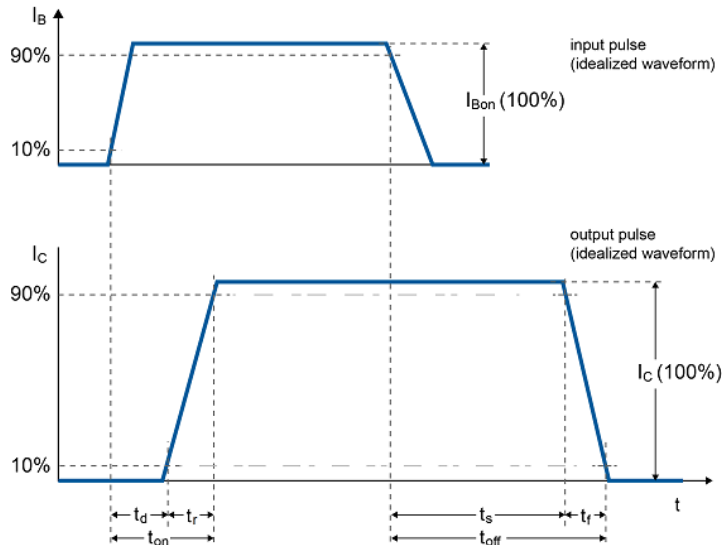

Fig 6. Timing Waveform

Typical Electrical Characteristics (@T_A = +25°C, unless otherwise specified.)

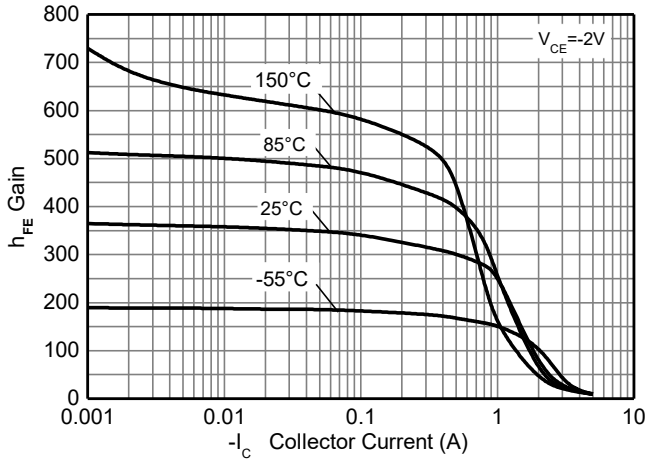

Fig. 7 $h_{FE} \ v \ I_C$

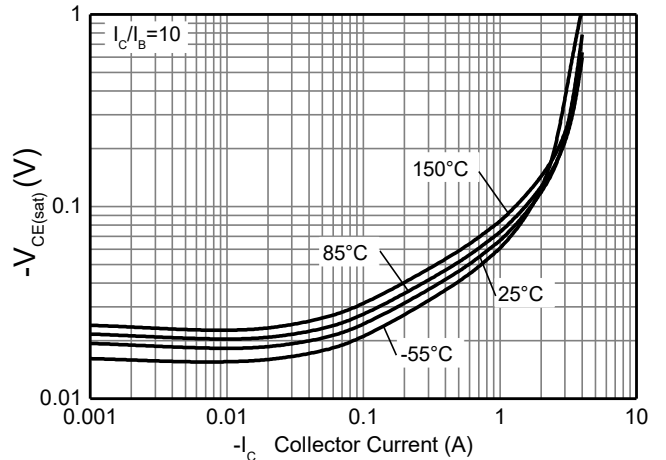

Fig. 8 $V_{CE(sat)} \ v \ I_C$

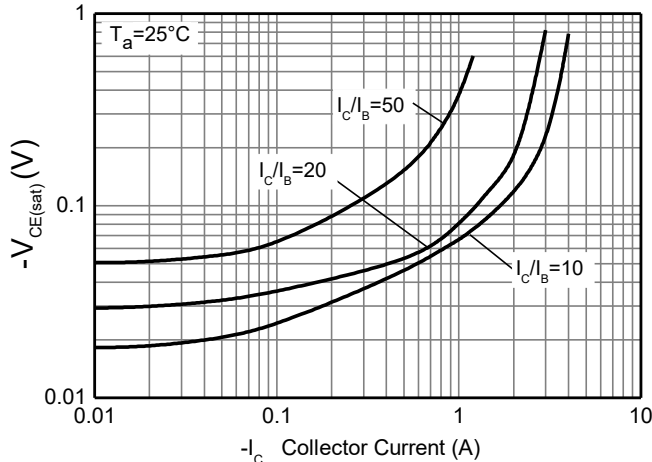

Fig. 9 $V_{CE(sat)} \ v \ I_C$

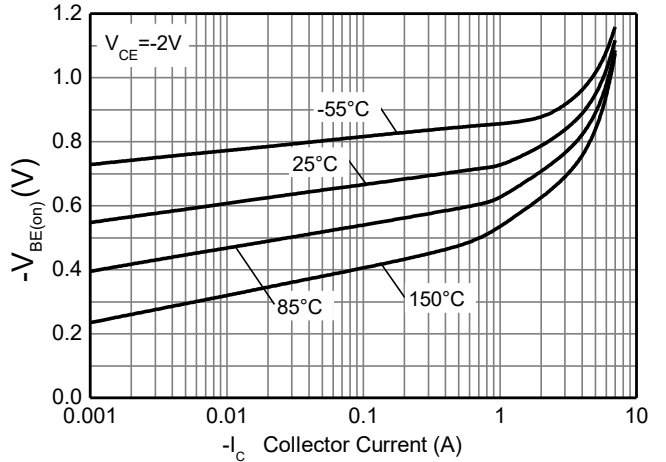

Fig. 10 $V_{BE(on)} \ v \ I_C$

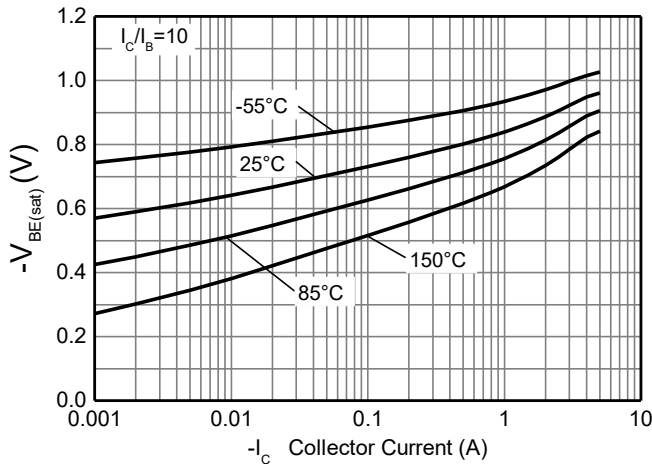

Fig. 11 $V_{BE(sat)} \ v \ I_C$

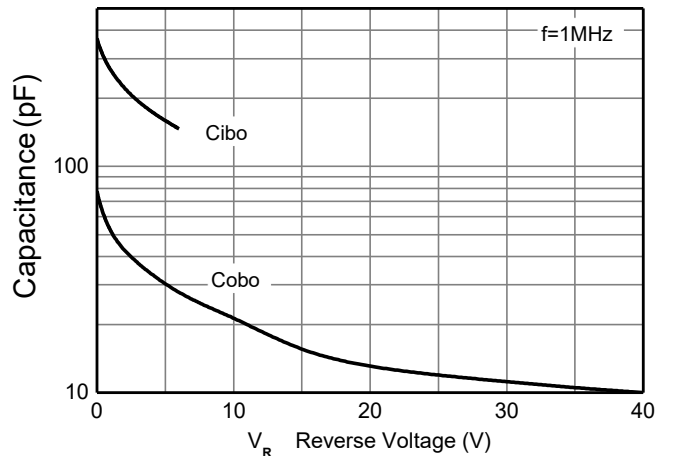

Fig. 12 Typical Junction Capacitance

Typical Electrical Characteristics (continued) (@ $T_A = +25^\circ\text{C}$, unless otherwise specified.)

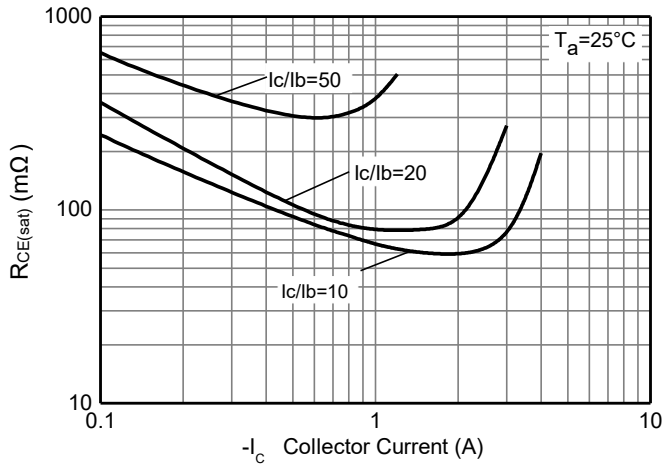

Fig. 13 $R_{CE(sat)} \text{ v } I_C$

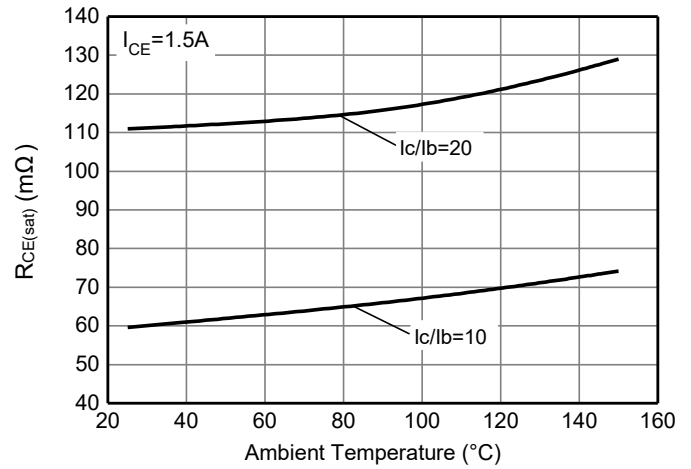

Fig. 14 $R_{CE(sat)} \text{ v } T_{amb}$

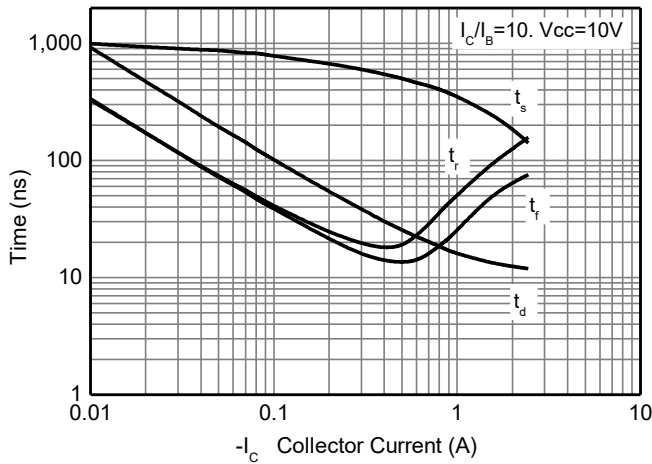
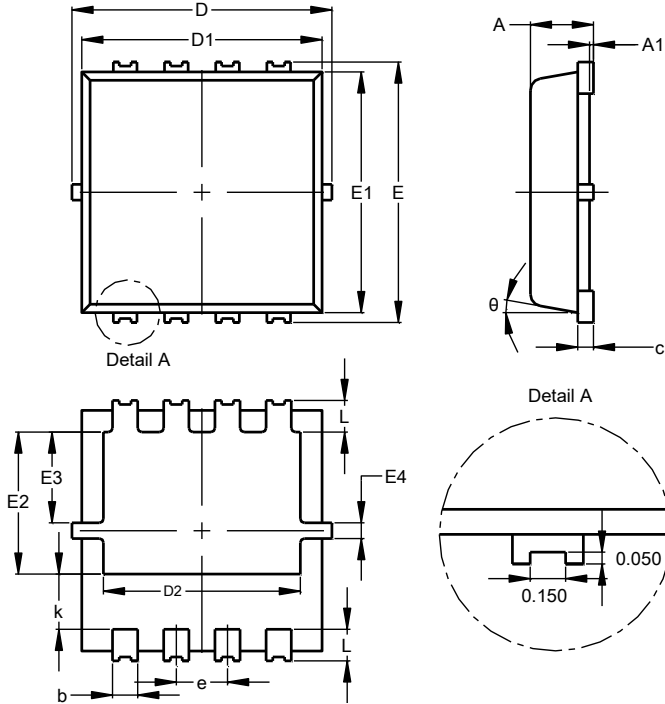

Fig. 15 Switching Performance

Package Outline Dimensions

Please see <http://www.diodes.com/package-outlines.html> for the latest version.

PowerDI3333-8/SWP (Type UX)



PowerDI3333-8/SWP (Type UX)			
Dim	Min	Max	Typ
A	0.75	0.85	0.80
A1	0.00	0.05	--
b	0.25	0.40	0.32
c	0.10	0.25	0.15
D	3.20	3.40	3.30
D1	2.95	3.15	3.05
D2	2.30	2.70	2.50
E	3.20	3.40	3.30
E1	2.95	3.15	3.05
E2	1.60	2.00	1.80
E3	0.95	1.35	1.15
E4	0.10	0.30	0.20
e	--	--	0.65
k	0.50	0.90	0.70
L	0.30	0.50	0.40
θ	0°	12°	10°
All Dimensions in mm			

Suggested Pad Layout

Please see <http://www.diodes.com/package-outlines.html> for the latest version.

PowerDI3333-8/SWP (Type UX)

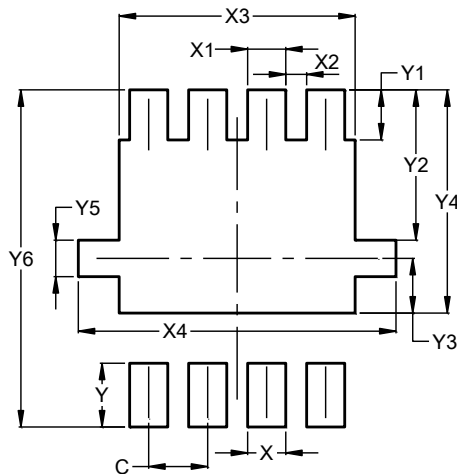

Dimensions	Value (in mm)
C	0.650
X	0.420
X1	0.420
X2	0.230
X3	2.600
X4	3.500
Y	0.700
Y1	0.550
Y2	1.650
Y3	0.600
Y4	2.450
Y5	0.400
Y6	3.700

- Notes:
- For high-voltage applications, the appropriate industry sector guidelines should be considered with regards to creepage and clearance distances between device terminals and PCB tracking.
 - Side wall tin plated package for wettable flanks in AOI.

IMPORTANT NOTICE

1. DIODES INCORPORATED (Diodes) AND ITS SUBSIDIARIES MAKE NO WARRANTY OF ANY KIND, EXPRESS OR IMPLIED, WITH REGARDS TO ANY INFORMATION CONTAINED IN THIS DOCUMENT, INCLUDING, BUT NOT LIMITED TO, THE IMPLIED WARRANTIES OF MERCHANTABILITY, FITNESS FOR A PARTICULAR PURPOSE OR NON-INFRINGEMENT OF THIRD PARTY INTELLECTUAL PROPERTY RIGHTS (AND THEIR EQUIVALENTS UNDER THE LAWS OF ANY JURISDICTION).
2. The Information contained herein is for informational purpose only and is provided only to illustrate the operation of Diodes' products described herein and application examples. Diodes does not assume any liability arising out of the application or use of this document or any product described herein. This document is intended for skilled and technically trained engineering customers and users who design with Diodes' products. Diodes' products may be used to facilitate safety-related applications; however, in all instances customers and users are responsible for (a) selecting the appropriate Diodes products for their applications, (b) evaluating the suitability of Diodes' products for their intended applications, (c) ensuring their applications, which incorporate Diodes' products, comply the applicable legal and regulatory requirements as well as safety and functional-safety related standards, and (d) ensuring they design with appropriate safeguards (including testing, validation, quality control techniques, redundancy, malfunction prevention, and appropriate treatment for aging degradation) to minimize the risks associated with their applications.
3. Diodes assumes no liability for any application-related information, support, assistance or feedback that may be provided by Diodes from time to time. Any customer or user of this document or products described herein will assume all risks and liabilities associated with such use, and will hold Diodes and all companies whose products are represented herein or on Diodes' websites, harmless against all damages and liabilities.
4. Products described herein may be covered by one or more United States, international or foreign patents and pending patent applications. Product names and markings noted herein may also be covered by one or more United States, international or foreign trademarks and trademark applications. Diodes does not convey any license under any of its intellectual property rights or the rights of any third parties (including third parties whose products and services may be described in this document or on Diodes' website) under this document.
5. Diodes' products are provided subject to Diodes' Standard Terms and Conditions of Sale (<https://www.diodes.com/about/company/terms-and-conditions/terms-and-conditions-of-sales/>) or other applicable terms. This document does not alter or expand the applicable warranties provided by Diodes. Diodes does not warrant or accept any liability whatsoever in respect of any products purchased through unauthorized sales channel.
6. Diodes' products and technology may not be used for or incorporated into any products or systems whose manufacture, use or sale is prohibited under any applicable laws and regulations. Should customers or users use Diodes' products in contravention of any applicable laws or regulations, or for any unintended or unauthorized application, customers and users will (a) be solely responsible for any damages, losses or penalties arising in connection therewith or as a result thereof, and (b) indemnify and hold Diodes and its representatives and agents harmless against any and all claims, damages, expenses, and attorney fees arising out of, directly or indirectly, any claim relating to any noncompliance with the applicable laws and regulations, as well as any unintended or unauthorized application.
7. While efforts have been made to ensure the information contained in this document is accurate, complete and current, it may contain technical inaccuracies, omissions and typographical errors. Diodes does not warrant that information contained in this document is error-free and Diodes is under no obligation to update or otherwise correct this information. Notwithstanding the foregoing, Diodes reserves the right to make modifications, enhancements, improvements, corrections or other changes without further notice to this document and any product described herein. This document is written in English but may be translated into multiple languages for reference. Only the English version of this document is the final and determinative format released by Diodes.
8. Any unauthorized copying, modification, distribution, transmission, display or other use of this document (or any portion hereof) is prohibited. Diodes assumes no responsibility for any losses incurred by the customers or users or any third parties arising from any such unauthorized use.
9. This Notice may be periodically updated with the most recent version available at <https://www.diodes.com/about/company/terms-and-conditions/important-notice>

The Diodes logo is a registered trademark of Diodes Incorporated in the United States and other countries.
All other trademarks are the property of their respective owners.
© 2025 Diodes Incorporated. All Rights Reserved.

www.diodes.com