

STANDARD PRODUCT LABEL

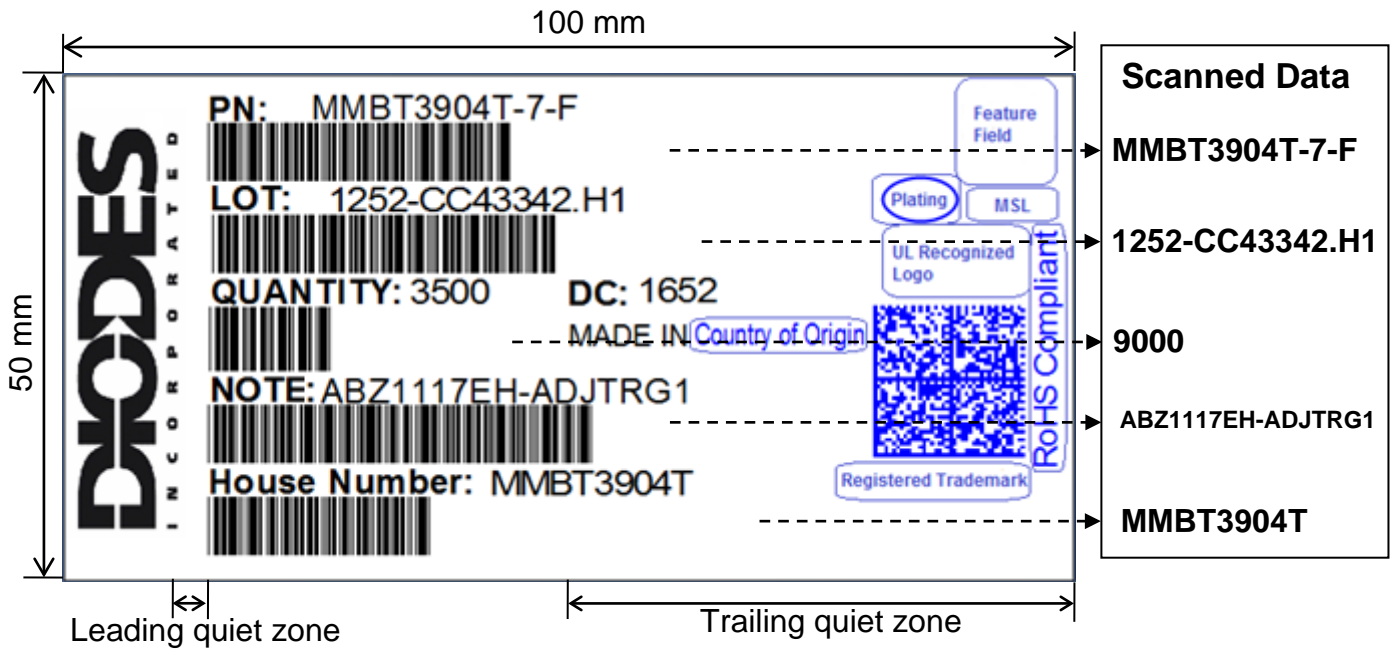

Fig. 1 Standard product label

Note 1: 2D barcode (Data Matrix) is optional by BU requirement.

Note 2: Deviation from the standard format and size may be allowed if justified and approved by Diodes corporate.

Examples of Product Labels



Fig. 2 Standard Label for a “Green” and Lead-Free Finish, RoHS compliant with Tin terminal finish and Moisture Sensitivity Level 1.



Fig. 3 Standard Label for SBR® Product that has Lead-Free Finish and is RoHS Compliant with Tin terminal finish. Moisture Sensitivity Level 1.



Fig. 4 Standard Label for a UL recognized, “Green” product, totally Lead-Free & fully RoHS Compliant with Tin terminal finish and Moisture Sensitivity Level 1.



Fig. 5 Standard Label for a totally Lead-Free product, RoHS Compliant Product with Tin terminal finish and Moisture Sensitivity Level 1.



Fig. 6 Supplemental Label added at Distribution point (primarily glass packaged product)

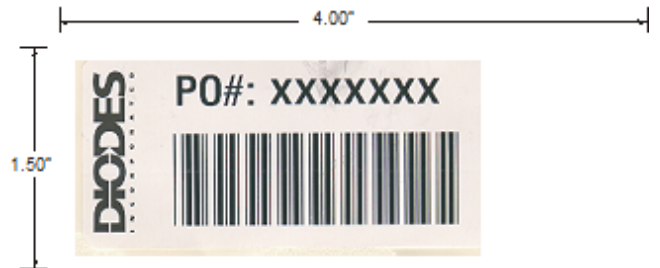







Fig. 7

STANDARD PRODUCT LABEL DEFINITIONS

PRODUCT LABEL TITLE FIELD FORMAT AND DEFINITION		
Title	Max Length / Format	Definition
P/N	16 Digit / Alphanumeric	Part number consists of generic device number followed by packaging code, which is assigned by Diodes Inc.
QTY	6 Digit / Alphanumeric	Unit quantity within the packaging or box/carton.
MADE IN (Country of origin)	Maintain Trailing Quiet Zone	In (Country of Origin) bracket, fill in Country of Origin.
LOT (D/C-LOT)	DC - 4 Digit (fixed) / Numeric (YYWW) LOT - 13 Digit / Alphanumeric maximum (Shall consist of factory code as suffix with a separator ".")	Traceability number (in the format of Date Code - Lot Number) assigned by the factory to identify a unique group of entities (which shall contain or be able to track information of wafer, operator, equipment, shift and etc. Individual manufacturing plant format is acceptable).
DC	Date Code	Standard 4 digit format (YYWW). Other format per BU requirement is acceptable.
NOTE	Alphanumeric	PO#, Internal work order, or Lot Number per BU requirement
House Number	Alphanumeric	Internal manufacturing Part Number
Feature Label		Lead-Free Finish.
Feature Label		Totally Lead-Free Product.
Feature Label		Lead-Free Finish and "Green" Product.
Feature Label		Totally Lead-Free and "Green" Product.
Terminal Finish		2nd Level Interconnect Indicator for Terminal Finish: x = 1 for SnAgCu x = 2 for Sn alloys with no Bi or Zn excluding SnAgCu x = 3 for Sn x = 4 for Precious Metal (NiPdAu, Ag, Au, NiPd) (no Sn) See JEDEC Standard No. 97 (JESD97) for full list.
RoHS Compliant	RoHS Compliant	Indicates product is RoHS Compliant as of production date
Moisture Sensitivity Level	MSLx	x = Actual Moisture Sensitivity Level
Registered Trademark	Only printed when required	Product Registered Trademark for example SBR®, PowerDI®, IntellIFET®
UL Graphical Icon		UL Recognized Component Mark

STANDARD PRODUCT LABEL LOGO



Title	Word "DIODES" (only)	Logo with "INCORPORATED"
Color Palette1	Blue PMS# 294	PMS# 294 (Word "DIODES" in Blue)/ PMS# 418 (Word "INCORPORATED" in Grey)
4 Color Process Equivalents (%)	C-100, M-56, Y-0, K-18	"DIODES" C-100, M-56, Y-0, K-18 "INCORPORATED" C-0, M-0, Y-30, K-79
Width/Heights Ratio2	W/H1 = 5.12	W/H2 = 4.14

1. The logo may also be reproduced in one color. The only acceptable colors for one color usage are Black or PMS# 418 Warm Grey.
2. The ratio must be maintained while resizing is needed to fit in the placeholder.

STANDARD PRODUCT LABEL BAR CODE

LINEAR BAR CODE CHARACTERISTICS	
X Dimension (width of the narrow lines)	Not less than 9 mils.
Symbology	Code 128
Height	0.225 Inch / 0.690 Inch (for PO Label)
Density	18 or less characters per inch
Ratio	2.0 / 3.0 (for PO Label)
Print Quality	Bar code print quality should be checked periodically with a verifier. Print quality should be in accordance with ANSI X3.182-1009, Bar Code Quality Guideline.
Data Characters	43 characters (0 to 9, A to Z, -, ., /, +, %, \$ and space)
Human Readable Character Height	0.165 inch (Normal) - Title 0.263 inch (Normal) – PO Label 0.165 inch (Bold) - Field

2D BAR CODE CHARACTERISTICS																					
X Dimension	9.86 to 14.78 mils maximum																				
Symbology	Data Matrix ECC-200																				
Print Quality	A minimum ISO/ANSI print quality grade of 1.5/10/660 (C) is required for the Data Matrix symbol.																				
Data Characters	43 characters (0 to 9, A to Z, -, ., /, +, %, \$ and space)																				
Data Structure	<p>Use of the format structure as defined by the ISO/IEC 15434 specifications. Structure is made up of a header, data stream, and trailer, with special character sequences used to identify each part and to separate each piece of data.</p> <table border="1" style="width: 100%; border-collapse: collapse;"> <thead> <tr> <th style="text-align: left;">Name</th> <th style="text-align: left;">Character</th> <th style="text-align: left;">ASCII value</th> <th style="text-align: left;">HEX value</th> </tr> </thead> <tbody> <tr> <td>Compliance Indicator</td> <td>] > (three characters)</td> <td>91, 41, 62</td> <td>5B, 29, 3E</td> </tr> <tr> <td>Record Separator</td> <td>R</td> <td>30</td> <td>1E</td> </tr> <tr> <td>Group Separator</td> <td>G^S</td> <td>29</td> <td>1D</td> </tr> <tr> <td>End of Transmission</td> <td>E^S O_T</td> <td>04</td> <td>04</td> </tr> </tbody> </table>	Name	Character	ASCII value	HEX value	Compliance Indicator] > (three characters)	91, 41, 62	5B, 29, 3E	Record Separator	R	30	1E	Group Separator	G ^S	29	1D	End of Transmission	E ^S O _T	04	04
Name	Character	ASCII value	HEX value																		
Compliance Indicator] > (three characters)	91, 41, 62	5B, 29, 3E																		
Record Separator	R	30	1E																		
Group Separator	G ^S	29	1D																		
End of Transmission	E ^S O _T	04	04																		
Data Contents	Part Number, Packing, Quantity, Lot Number, Manufacture Code, Vendor, Box No, MarkingID, Origin																				
Data Identifiers	1P (Part Number), 2P (Packing), 1Q (Quantity), 1L (Lot Number), 1D (Manufacture Code), 1V (Vendor), 1B (Box no), 1M (Marking ID), 1O (Origin)																				
Example of scanned Data																					
																					
<p>Green = Default data Blue = Record Separator and Group Separator Red = Data Identifiers Yellow = Data Content</p>																					

1. Product labels must be affixed to all product reels, trays and inner boxes.
2. Product labels must have all the information fields listed above.
3. PO label must be affixed to all outer boxes.
4. Labels may be printed by any means or technology including, but not limited to, direct transfer, thermal transfer, laser or ink jet printing.
5. See AP02005 for carton dimensions/specifications.
6. All products will be periodically inspected for conformance to this specification.
7. Logo and all printing in black only. Diodes Inc. Logo artwork available upon request.

ESD Sensitive Product WARNING LABEL



Package Label
(Reel Label where space permits)



Reel Label for restricted space

Note: A reel with "ESD Marking" molded in may be used in lieu of the required reel label.

CALIFORNIA PROPOSITION 65 WARNING LABEL

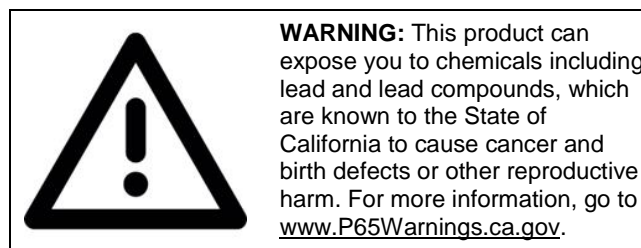

Note : For products sold into California, the above label, or similar, will be affixed on the product packaging.

LABEL PLACEMENT

1. All product labels must be placed per this specification.
2. 7" reels require a Bar Code label only unless ESD Sensitive.
3. Label placement for 7" and 13" reels are per Figure 1 of this specification.
4. Label placement for Ammo Packs are per Figure 2 of this specification.
5. Bar Code Product Labels must be affixed to all product reels, trays, ammo packs, and inner boxes.
6. PO Labels must be affixed to all outer boxes in the designated area (see AP2005 for label placement).
7. ESD Sensitive Warning labels must be affixed to all product reels, trays, ammo packs, and inner boxes where the ESD classification of the product is _H1C HBM or LM1C MM. Where there is no inner box the label is to be placed on the outer carton.
8. All product will be periodically inspected for conformance to this specification.

7" AND 13" REEL LABEL PLACEMENT - FIGURE 1

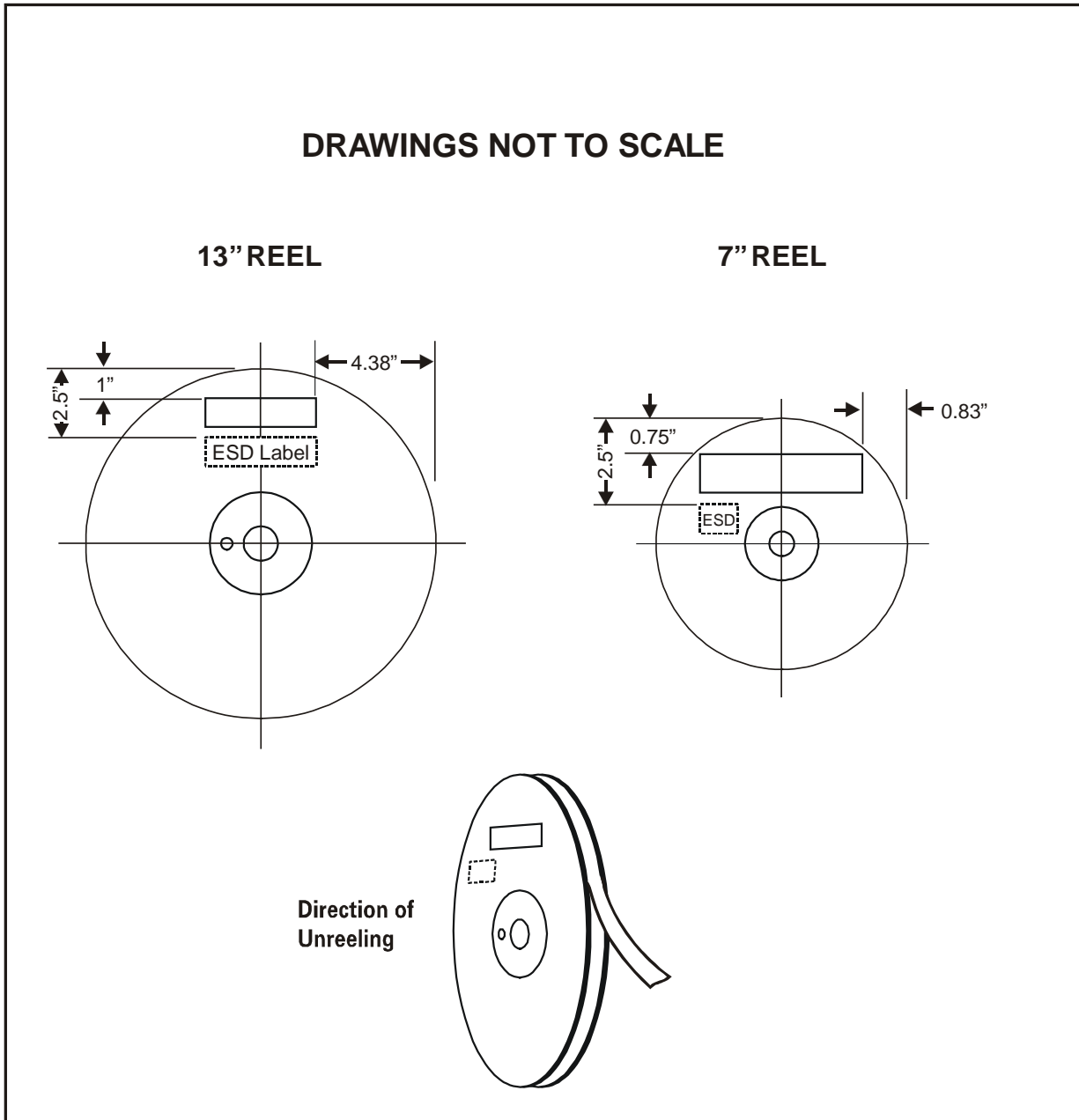

1. All Bar Code product labels must be clearly legible and shall be placed per this specification.
2. Labels shall be affixed to the top portion of each reel. Text shall be Human readable.
3. All reels shall include a Bar Code label.
4. All products will be periodically inspected for conformance to this specification.

AMMO PACK LABEL PLACEMENT – FIGURE 2

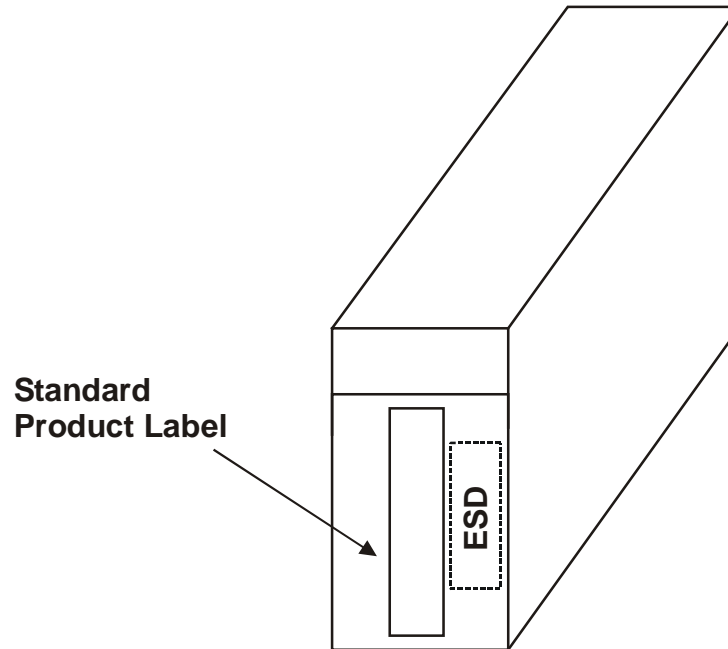

1. Bar Code Labels shall be affixed to the top of the ammo pack, 1" from front carton edge.
2. Labels will be centered between carton edges and may NOT cover carton openings.
3. Top of readable text shall be toward left side of carton.
4. All product labels must be placed per this specification.
5. All products will be periodically inspected for conformance to this specification.