

Package Outline Dimensions

X3-DSN2718-6

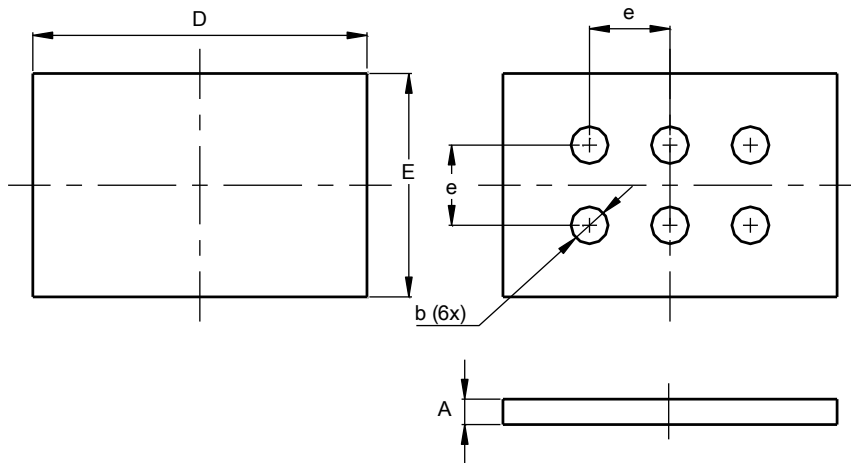

X3-DSN2718-6			
Dim	Min	Max	Typ
A	0.16	0.26	0.21
b	0.27	0.33	0.30
D	2.65	2.75	2.70
E	1.76	1.86	1.81
e	0.62	0.68	0.65
All Dimensions in mm			

Suggested Pad Layout

X3-DSN2718-6

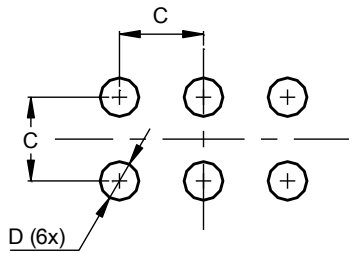

Dimensions	Value (in mm)
C	0.65
D	0.30

ALL DIMENSIONS ARE NOMINAL VALUES SHOWN IN MILLIMETERS

Note: The suggested land pattern dimensions have been provided for reference only, as actual pad layouts may vary depending on application. These numbers may be modified based on user equipment capability or fabrication criteria. A more robust pattern may be desired for wave soldering and is calculated by adding 0.2 mm to the 'Z' dimension. For further information, please reference document IPC-7351A, Naming Convention for Standard SMT Land Patterns, and for International grid details, please see document IEC, Publication 97.