

Package Outline Dimensions

W-QFN4040-20 (Type A1)

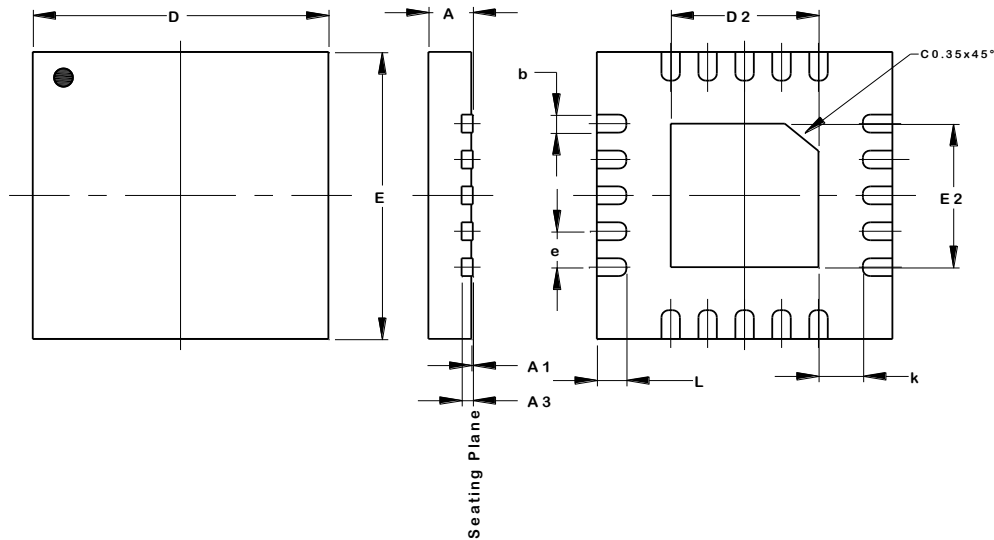

W-QFN4040-20 (Type A1)			
Dim	Min	Max	Typ
A	0.70	0.80	0.75
A1	0.00	0.05	0.02
A3	0.203 REF		
b	0.20	0.30	0.25
D	4.00 BSC		
D2	1.95	2.05	2.00
E	4.00 BSC		
E2	1.95	2.05	2.00
e	0.50 BSC		
k	0.20	--	--
L	0.30	0.50	0.40
All Dimensions in mm			

Suggested Pad Layout

W-QFN4040-20 (Type A1)

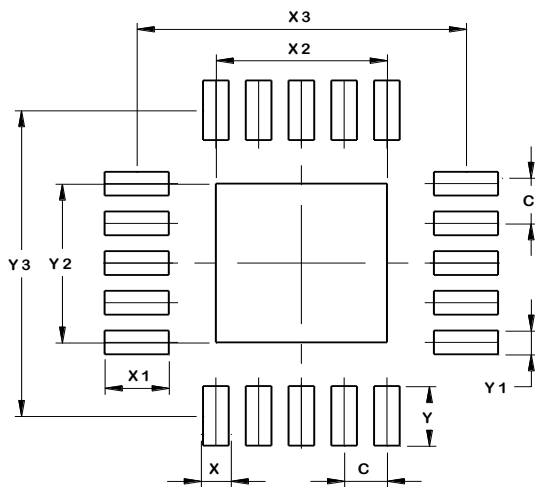

Dimensions	Value (in mm)
C	0.500
X	0.300
X1	0.750
X2	2.000
X3	3.850
Y	0.750
Y1	0.300
Y2	2.000
Y3	3.850

ALL DIMENSIONS ARE NOMINAL VALUES SHOWN IN MILLIMETERS

Note: The suggested land pattern dimensions have been provided for reference only, as actual pad layouts may vary depending on application. These numbers may be modified based on user equipment capability or fabrication criteria. A more robust pattern may be desired for wave soldering and is calculated by adding 0.2 mm to the 'Z' dimension. For further information, please reference document IPC-7351A, Naming Convention for Standard SMT Land Patterns, and for International grid details, please see document IEC, Publication 97.