



---

DATE: 7 December, 2016

PCN #: 2250

PCN Title: Change of Assembly Materials, Assembly Process and Mechanical Specification

Dear Customer:

This is an announcement of change(s) to products that are currently being offered by Diodes Incorporated.

We request that you acknowledge receipt of this notification within 30 days of the date of this PCN. If you require samples for evaluation purposes, please make a request within 30 days as well. Otherwise, samples may not be built prior to this change. Please refer to the implementation date of this change as it is stated in the attached PCN form. Please contact your local Diodes sales representative to acknowledge receipt of this PCN and for any sample requests.

The changes announced in this PCN will not be implemented earlier than 90 days from the notification date stated in the attached PCN form.

Previously agreed upon customer specific change process requirements or device specific requirements will be addressed separately.

For questions or clarification regarding this PCN, please contact your local Diodes sales representative.

Sincerely,

Diodes Incorporated PCN Team

**PRODUCT CHANGE NOTICE****PCN-2250 REV 00**

Notification Date:	Implementation Date:	Product Family:	Change Type:	PCN #:
7 December, 2016	7 March, 2017	Analog	Assembly Materials/Process, and Mechanical Specification	<b>2250</b>
<b>TITLE</b>				
Change of Assembly Materials/Process, and Mechanical Specifications for Various Parts				
<b>DESCRIPTION OF CHANGE</b>				
This PCN is being issued to notify customers that in order to assure continuity of supply, Diodes has qualified the changes identified below on selected Analog devices. Full electrical characterization and reliability testing have been completed to ensure that no changes in product reliability, device functionality or data sheet electrical specifications exist. There will be no change to the Function of affected products.				
<b>IMPACT</b>				
There will be no change in product performance, but the form and fit will have changes for various package types.				
<b>PRODUCTS AFFECTED</b>				
<ol style="list-style-type: none"><li>1. MC80E &amp; MC89C - Marking method will change from Ink to Laser Marking, see Table 1.</li><li>2. A(G)PR34330CMPTR-G1 Lead frame change, see Table 2<ol style="list-style-type: none"><li>a. Lead frame change from SOP8/PP(5R)-A(Existing L/F) to SOP8/PP(5R)-E(New L/F)</li><li>b. Drain (Pin5) connection change from three wire (Existing L/F) to Lead (New L/F)</li></ol></li><li>3. SOT89-5 Lead frame will change from GND (SOT-89-5L/6L) to SOT-89-5L see Table 3 and <i>Figure 1</i></li><li>4. POD change for package SO-16, A2 (typical) is changed from 1.45 mm to 1.05 mm, see Table 4 and <i>Figure 2</i></li><li>5. POD change for package QFN3030, A is changed from 0.55 mm to 0.6 mm, and the Pin1 indicator shape has changed, see Table 5 and <i>Figure 3</i>.</li><li>6. POD change for package QFN4040-16, A is changed from 0.75 mm to 0.6 mm, see Table 6 and <i>Figure 4</i></li><li>7. POD change for package QFN4040-20, A is changed from 0.75 mm to 0.6 mm, see Table 7 and <i>Figure 5</i></li><li>8. POD change for package QFN5050, A is changed from 0.75 mm to 0.6 mm, see Table 8 and <i>Figure 6</i></li></ol>				
<b>WEB LINKS</b>				
<b>Manufacturer's Notice:</b>	<a href="http://www.diodes.com/pcns">http://www.diodes.com/pcns</a>			
<b>For More Information Contact:</b>	<a href="http://www.diodes.com/contacts.html">http://www.diodes.com/contacts.html</a>			
<b>Data Sheet:</b>	<a href="http://www.diodes.com/catalog">http://www.diodes.com/catalog</a>			
<b>DISCLAIMER</b>				
Unless a Diodes Incorporated Sales representative is contacted in writing within 30 days of the posting of this notice, all changes described in this announcement are considered approved.				

Table 1 - Marking method will change from Ink to Laser Marking					
MC80E	MC89C				

Table 2 - Leadframe Changes					
APR34330CMPTR-G1	GPR34330CMPTR-G1				

Table 3 - Leadframe Changes to SOT-89; See Figure 1					
AH9281RTR-G1	AP2112R5-1.2TRG1	AP2112R5-3.3TRG1	AP2112R5A-2.6TRG1	AP2115R5-2.5TRG1	AP2115R5A-2.5TRG1
AH9281RTR-G1	AP2112R5-1.8TRG1	AP2112R5A-1.2TRG1	AP2112R5A-3.3TRG1	AP2115R5-3.3TRG1	AP2115R5A-3.3TRG1
AH9282RTR-G1	AP2112R5-2.5TRG1	AP2112R5A-1.8TRG1	AP2115R5-1.2TRG1	AP2115R5A-1.2TRG1	
AH9282RTR-G1	AP2112R5-2.6TRG1	AP2112R5A-2.5TRG1	AP2115R5-1.8TRG1	AP2115R5A-1.8TRG1	

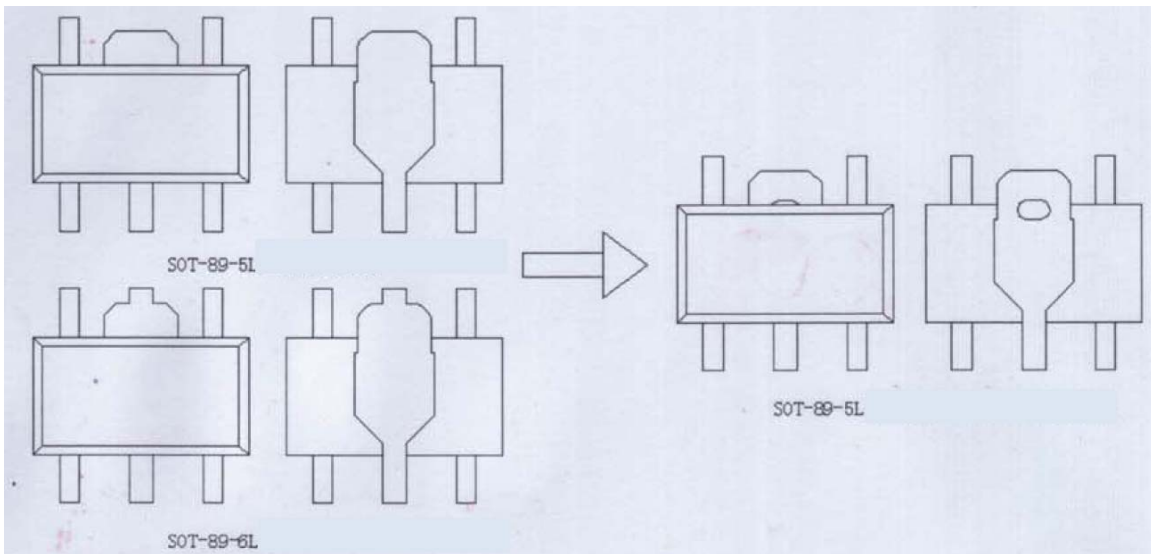
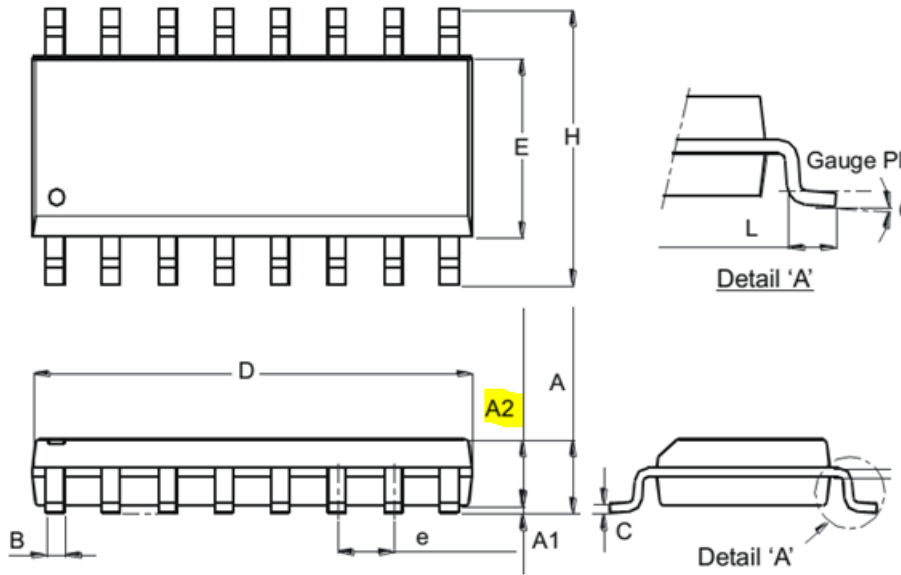

Figure 1: SOT-89 Changes

**Table 4 - POD Changes to SO-16; See Figure 2**

PAM8403DR	PAM8403DR-H	PAM8003DR	PAM8004DR	PAM8008DR	PAM8406DR
-----------	-------------	-----------	-----------	-----------	-----------



	<b>From</b>	<b>To</b>
A2(mm) Nom	1.45	
A2(mm) Min	1.35	1.02
A2(mm) Max	1.55	

**Figure 2: SO-16 Changes**

Table 5 - POD Changes to QFN3030; See Figure 3				
PAM8908JER				

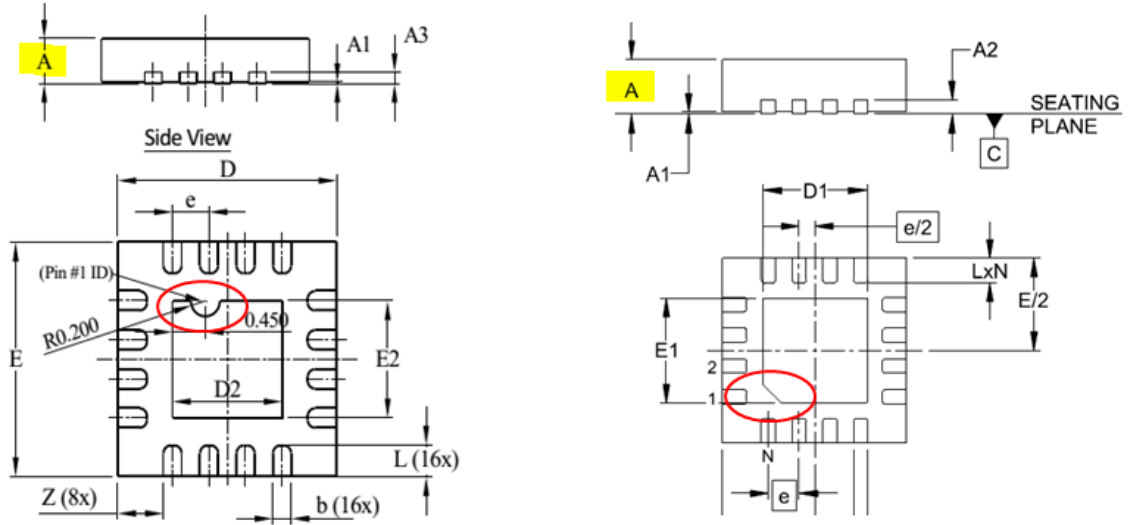



	From	To
Pin #1 ID		
A(mm) Nom	0.5	0.6
A(mm) Min	0.4	0.55
A(mm) Max	0.6	0.65

Figure 3: QFN3030 Changes

Table 6 - POD Changes to DFN4040; See Figure 4					
PAM8902KER	PAM8902HKER				

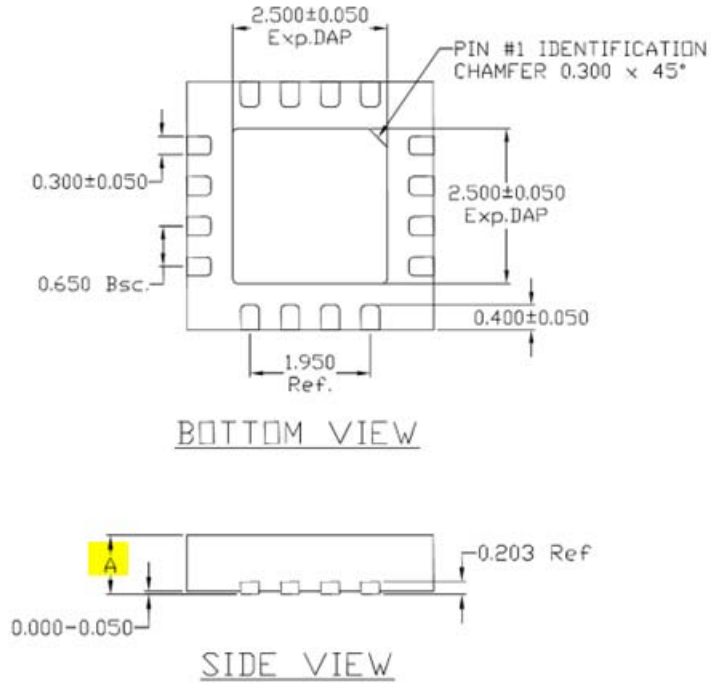

	<b>From</b>	<b>To</b>
A(mm) Nom	0.75	0.6
A(mm) Min	0.7	0.55
A(mm) Max	0.8	0.65

Figure 4: QFN4040-16 Changes

**Table 7 - POD Changes to QFN4040; See Figure 5**

PAM8404KGR					
------------	--	--	--	--	--

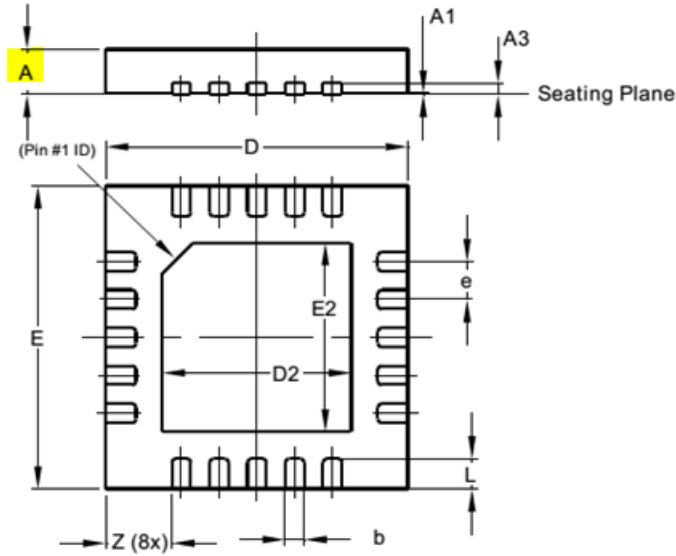

	<b>From</b>	<b>To</b>
A(mm) Nom	0.75	0.6
A(mm) Min	0.7	0.55
A(mm) Max	0.8	0.65

Figure 5: QFN4040-20 Changes

**Table 8 - POD Changes to QFN5050; See Figure 6**

PAM8006ATR	PAM8620TR				
------------	-----------	--	--	--	--

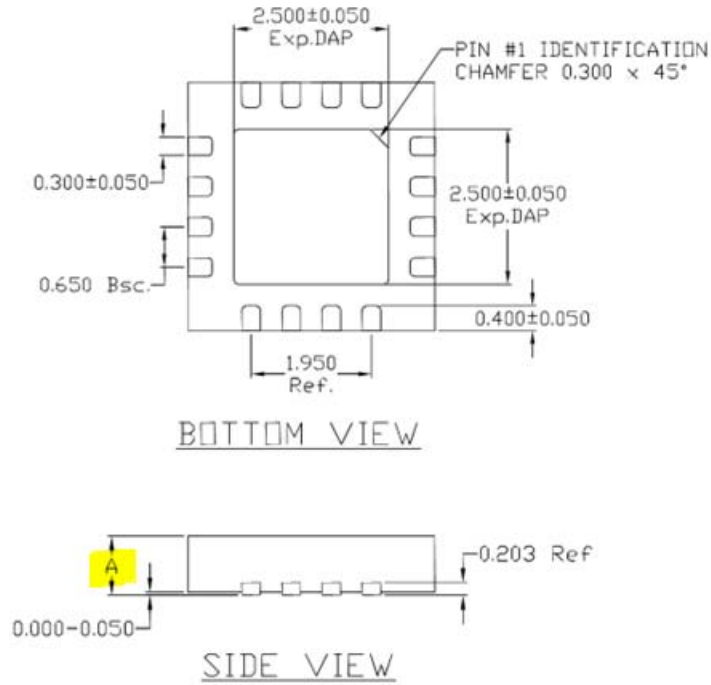

	<b>From</b>	<b>To</b>
A(mm) Nom	0.75	0.6
A(mm) Min	0.7	0.55
A(mm) Max	0.8	0.65

Figure 6: QFN5050 Changes