

General Description

The ZXLD1370/1 EV4 1.5A board uses the Buck-Boost topology working at Boundary Conduction Mode. It can perform step-down or boost up power conversion according to the output LEDs load vs. input voltage. It is designed for driving a high LED current from a wide range voltage source. The board can operate from an input supply between 10V and 30V and provides an externally adjustable output current of up to 1.5A. The ZXLD1370/1 EV4 board can provide more than 40 watts of output power.

Key Features

- Wide input voltage range: 10V to 30V
- Up to 1.5A output current
- Single pin on/off and brightness control using DC voltage or PWM
- Up to 1MHz switching frequency
- ±5% output current accuracy
- Inherent open-circuit LED protection
- High-Side Current Sense
- Hysteretic Control: No Compensation
- Adjustable output LED Current
- TSSOP-16EP package for large output power application
- RoHS compliant

Applications

- High lumen LED Bulb
- Automotive high power LED lamp

ZXLD1370/1 EV4 Specifications

Parameter	Value
Input Voltage	10 to 30V _{DC} (1371) 10 to 20V _{DC} (1370)
Output Power	30 – 40W
LED Current	1.5A (Adjustable)
LED Voltage	27V
Efficiency	~85%
Number of LEDs	9 LEDs in series (Under Tested)
XYZ Dimension	3.00" x 3.25" x 0.5"
ROHS Compliance	Yes

Evaluation Board



Figure 1: Top View

Connection Instructions

Input Voltage: 10 to 30V_{DC} (DC+, DC-)
LED Outputs: LED+ (Red), LED- (Black)

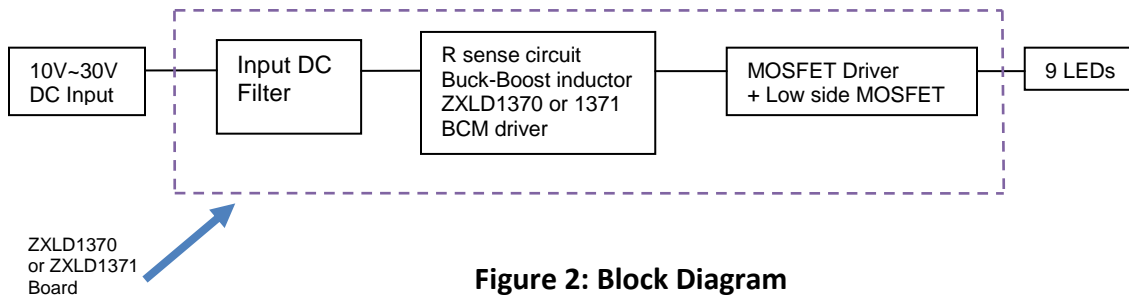

Evaluation Board Schematic

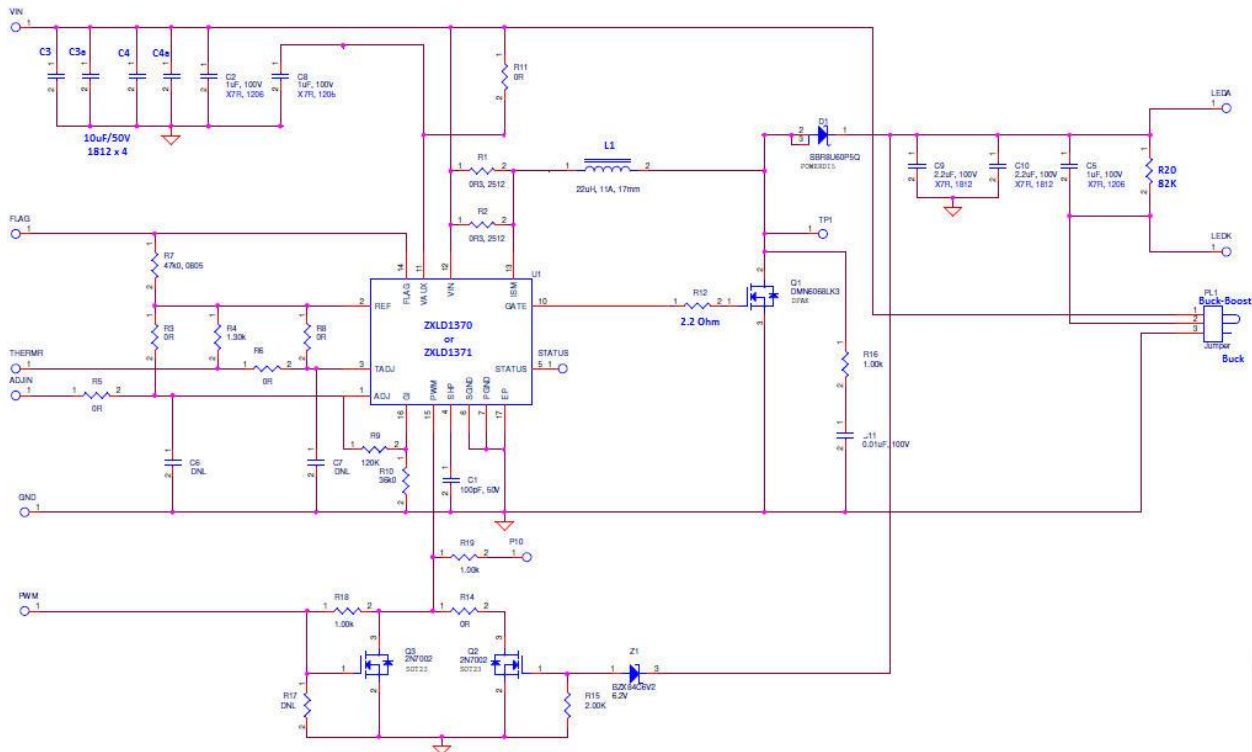

Figure 3: Evaluation Board Schematic

Evaluation Board Layout

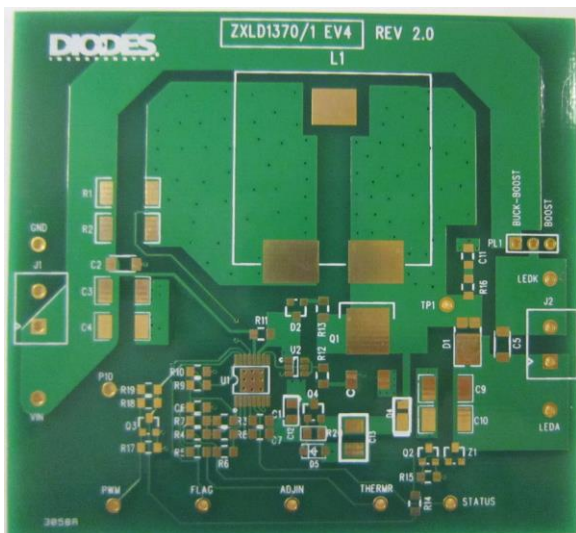

Figure 4: PCB Board Layout Top View

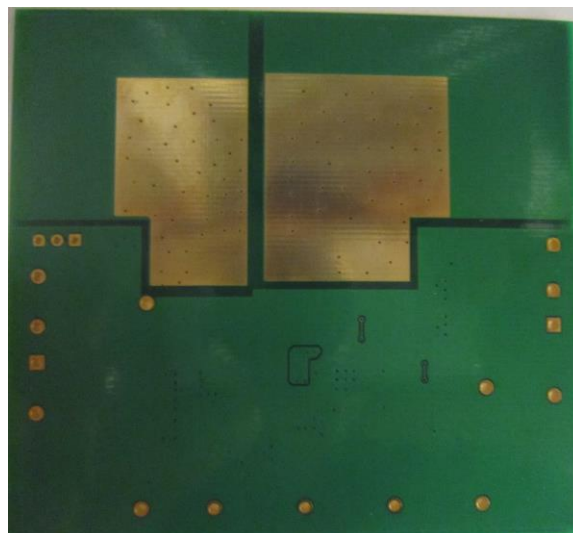

Figure 5: PCB Board Layout Bottom View

Quick Start Guide

1. By default, the evaluation board is preset at 1.5A LED current by R1 & R2.
2. Ensure that the DC source is switched OFF or disconnected.
3. Connect the 15V_{DC} power supply to two test points of “DC input” on the left side of the board.
4. Connect the anode wire of external LED string to LED+ output test point.
5. Connect the cathode wire of external LED string to LED- output test point.
6. Turn on the main switch. LED string should light up.

Bill of Material

#	Name	Quantity	Part number	Manufacturer	Description
1	U1	1	ZXLD1370EST16TC or ZXLD1371EST16TC	Diodes Inc	LED Driver TSSOP16L
2	U2	0	Not fitted		
3	Q1	1	DMN6068LK3	Diodes Inc	MOSFET 60V/8.5A DPAK
4	Q2	1	2N7002	Diodes Inc	MOSFET 60V/115mA SOT23
5	Q3	0	Not fitted		
6	D1	1	PDS3100	Diodes Inc	Freewheeling diode 100V/3A PowerDI5

7	D2	0	Not fitted		
8	D3	0	Not fitted		
9	Z1	1	BZX84B39	Diodes Inc	39V 350mW Zener Diode SOT23
10	L1	1	7443641500	Würth	15µH/30A SMD 28.5x19.5x18.5mm
11	C1	1	C0805C102K3RACTU	Kemet	1000pF Cer Cap 25V 10% X7R 0805
12	C2	2	C1206C104K5RAC7867	Kemet	1µF Cer Cap 50V 10% X7R 1206
13	C3, C3A, C4, C4A	4	C1812X106K050T	Holy Stone	10µF Cer Cap 50V 10% X7R 1812
14	C5	2	GRM31CR72A105KA01L	Murata	1µF Cer Cap 100V 10% X7R 1206
15	C6	1	GRM21BR61E106KA73L	Murata	10µF Cer Cap 25V 10% X5R 0805
16	C7	1	C0805C104K5RACTU	Kemet	0.1µF Cer Cap 50V 10% X7R 0805
17	C8	1	C1206X475K050T	Holy Stone	4.7µF Cer Cap 35V 10% X7R 1206
18	C9, C10	2	C1812X225K050T	Holy Stone	2.2µF Cer Cap 50V 10% X7R 1812
19	C11	0	Not fitted		
20	R1	1	RLP73K3AR15JTE	TE Connectivity	0.15Ω Resistor 2W 1% 2512
21	R2	2	RLP73K3AR30JTE	TE Connectivity	0.30Ω Resistor 2W 1% 2512
22	R3, R5, R6, R8, R11, R14	6	CRCW08050000Z0EA	Vishay	0 Ω Resistor 1/8W 0805
23	R4	1	RC0805FR-071K3L	Yageo	1.3kΩ Resistor 1/8W 1% 0805
24	R7	1	RC0805FR-0747KL	Yageo	47kΩ Resistor 1/8W 1% 0805
25	R9, R10	2	RC0805FR-0736KL	Yageo	36kΩ Resistor 1/8W 1% 0805
26	R12	1	RC0805FR-072R2L	Yageo	2.2Ω Resistor 1/8W 1% 0805
27	R13	1	RC0805FR-075R11L	Yageo	5.1Ω Resistor 1/8W 1% 0805
28	R15, R17	2	RC0805FR-0720KL	Yageo	20kΩ Resistor 1/8W 1% 0805
29	R16, R18, R19	3	RC0805FR-071KL	Yageo	1kΩ Resistor 1/8W 1% 0805
30	R20	1	RC0805FR-0782KL	Yageo	82kΩ Resistor 1/8W 1% 0805
31	J1	1	1776244-2	TE Connectivity	TERM BLOCK 2POS SIDE ENTRY 5MM
32	PL1	1	800-10-003-10-001000	Mill-Max	SIP HEADER 3 POS
33	Vin, GND, PWM, TP1, LEDA, LEDK	6	5121K-ND	Keystone	Test point

OPERATION

In Buck-boost mode the LED current is sensed by the series resistor ($R1//R2$). An output from the control loop drives the input of a comparator. The comparator drives the gate of the external NMOS switch transistor via 'GATE' pin. When the NMOS switch is on, current flows from VIN, via ($R1//R2$), inductor and switch to ground and increases until a high value is reached. Then, GATE goes low, the switch turns off and the current flows through ($R1//R2$), the inductor, D1 and the LED, to 'VIN' (Buck-boost mode). When the inductor current has gone low, 'GATE' goes high, and the cycle of events repeats. The circuit oscillates. The average current in the LEDs is equal to the average of the maximum and minimum threshold currents. The ripple current (hysteresis) is equal to the difference between the thresholds. The average current in the LED is always less than the average current in the inductor and the ratio between these currents is set by the values of resistors R9 and R10. The peak current in the LED is equal to the peak current in the inductor. The control loop keeps the average LED current at the level set by the voltage on the 'ADJ' pin. Loop compensation is achieved by C1.

PWM Terminal (PWM output current control/dimming)

The LED current can be adjusted digitally, by applying a low frequency PWM logic signal to the 'PWM' pin to turn the controller on and off. This will produce an average output current proportional to the duty cycle of the control signal. During PWM operation, the device remains powered up and only the output switch is switched by the control signal.

The device can be shut down by taking the PWM pin to $< 0.4V$ with a short to 0V or suitable open collector NPN, or open drain NMOS transistor, for $>15ms$. In the shutdown state, most of the circuitry inside the device is off and the quiescent current will be typically $90\mu A$.

Functional Performance (9 series LEDs @1.5A)

MFG	Board Type	VIN (VDC)	IIN (A)	PIN (W)	VLED (V)	ILED (A)	PLED (W)	Fs Switching Freq (Hz)	Efficiency (%)
Diodes Inc	ZXLD1370/1EV4 Module Board	10	5.04	50.4	27.43	1.42	39.01	412K	77.5
		12	4.40	52.7	28.00	1.55	43.40	404K	82.4
		15	3.34	50.1	27.26	1.55	42.25	416K	84.3
		18	2.68	48.3	27.36	1.52	41.59	420K	86.1
		20	2.37	47.4	27.20	1.51	41.07	460K	86.7
		24	1.92	45.9	27.48	1.44	39.57	510K	86.0
		30	1.53	45.9	27.40	1.44	39.46	560K	85.5

Functional Performance

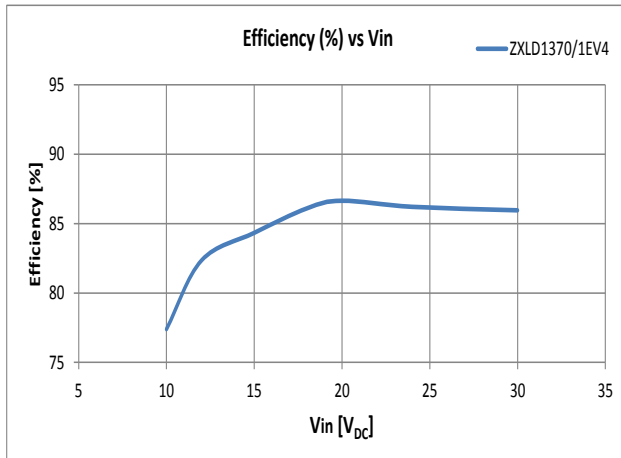

Figure 1. Efficiency vs. Vin

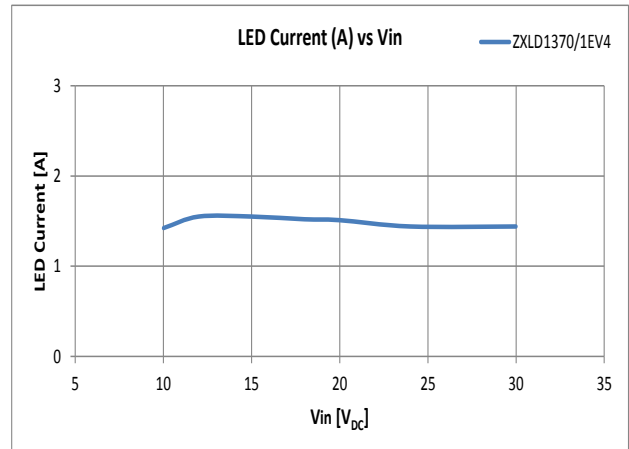

Figure 2. LED Current vs. Vin

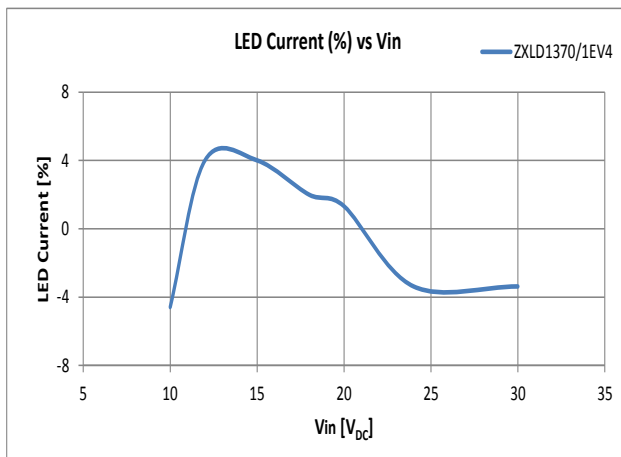
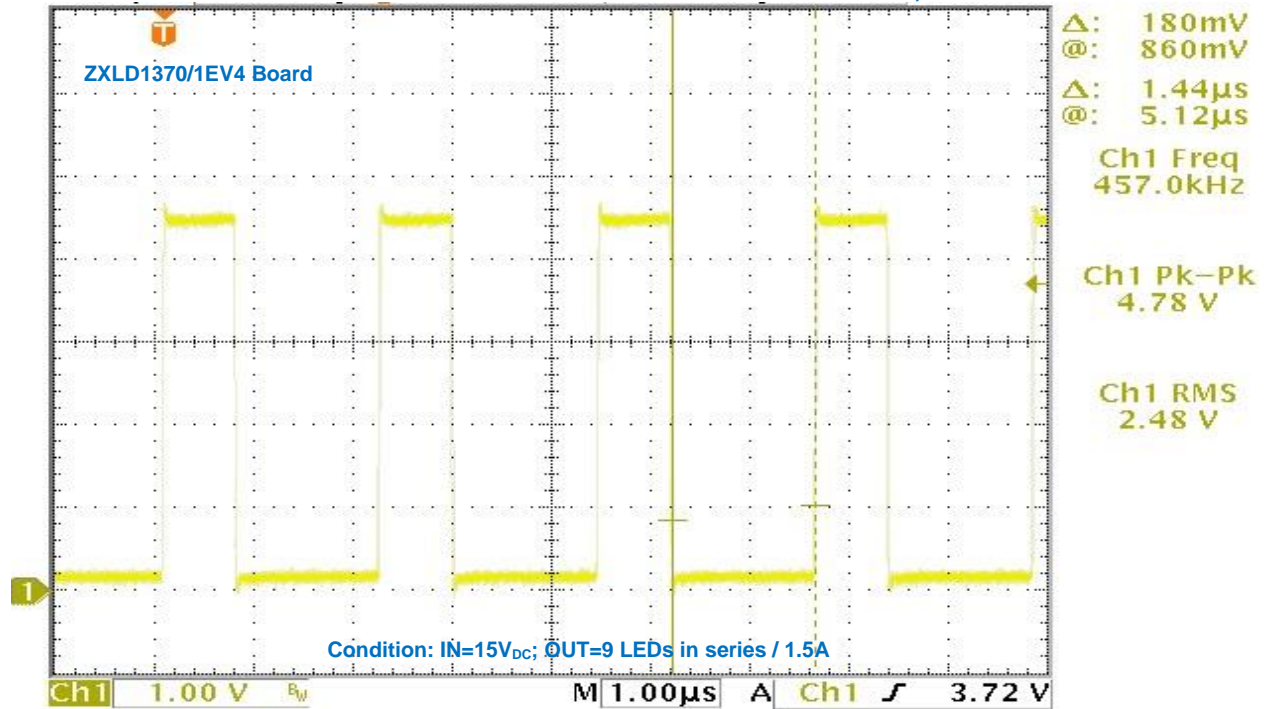
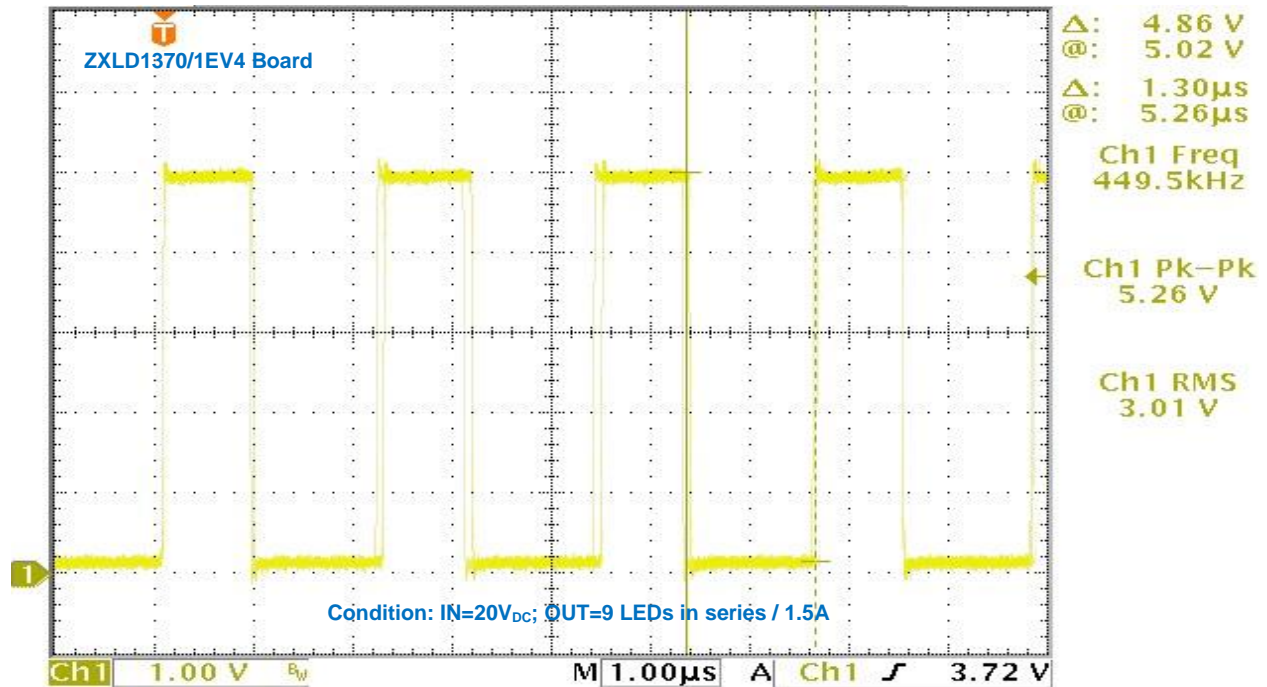

Figure 3. LED Current (%) vs. Vin

Waveform #1 (Voltage across Drain and Source, $V_{in}=15V_{DC}$, $I_{LED}=1.5A$)



Waveform #2 (Voltage across Drain and Source, $V_{in}=20V_{DC}$, $I_{LED}=1.5A$)



Waveform #3 (Voltage across Drain and Source, $V_{in}=24V_{DC}$, $I_{LED}=1.5A$)

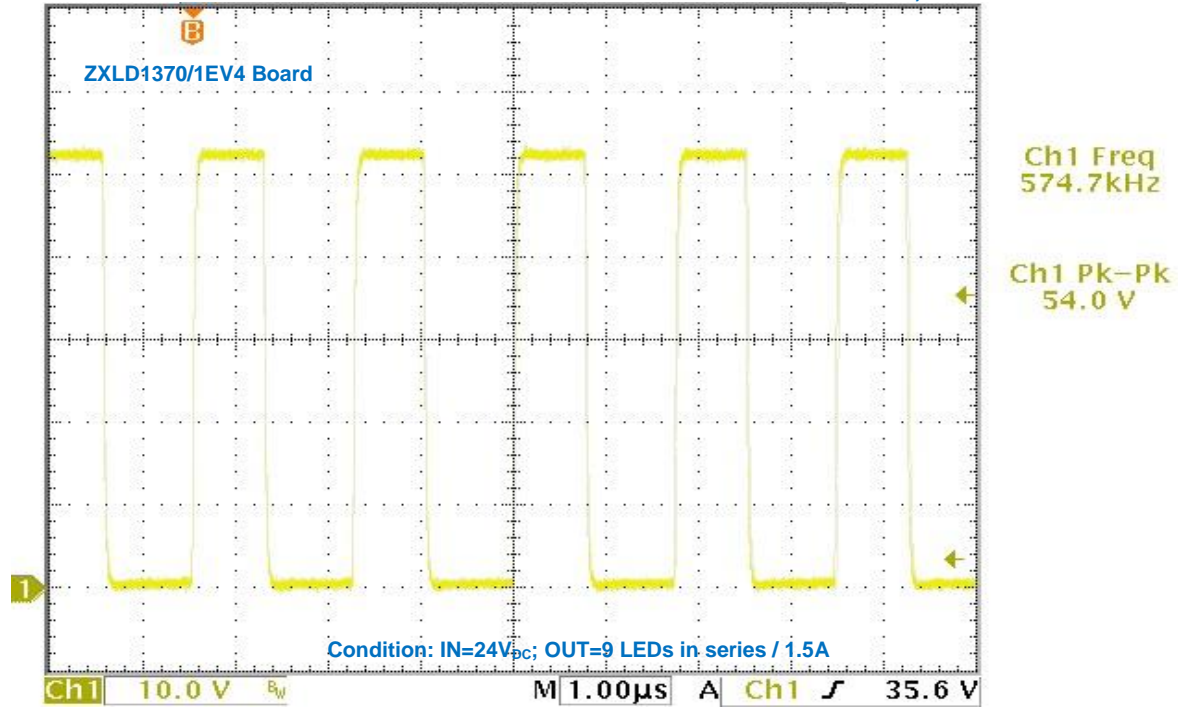

Waveform #4 (Voltage across Drain and Source, $V_{in}=30V_{DC}$, $I_{LED}=1.5A$)

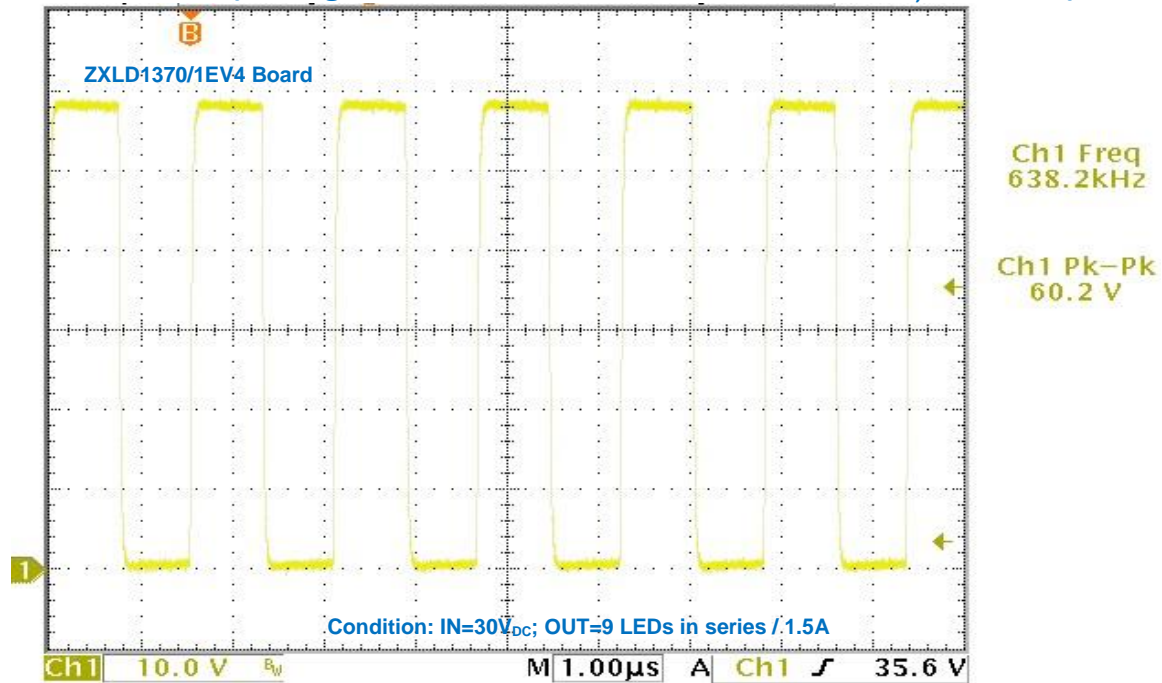

Waveform #5 (Output Voltage Ripple, $V_{in}=20V_{DC}$, $I_{LED}=1.5A$)

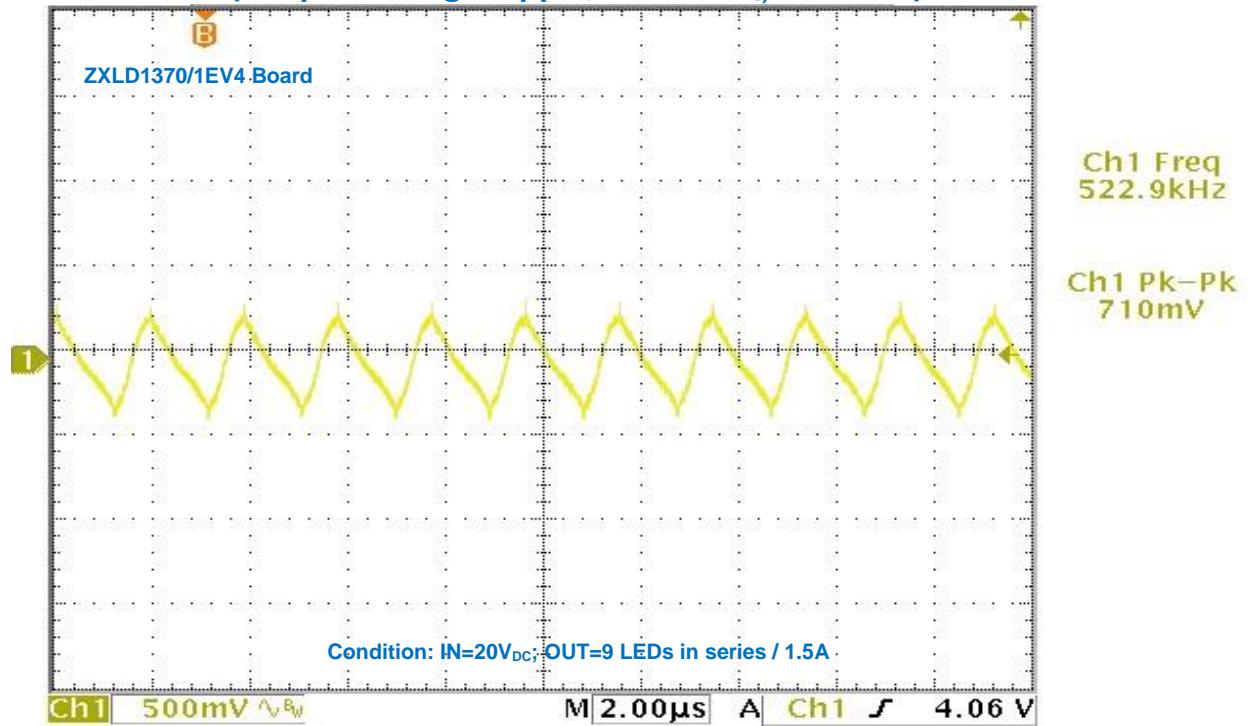

IMPORTANT NOTICE

DIODES INCORPORATED MAKES NO WARRANTY OF ANY KIND, EXPRESS OR IMPLIED, WITH REGARDS TO THIS DOCUMENT, INCLUDING, BUT NOT LIMITED TO, THE IMPLIED WARRANTIES OF MERCHANTABILITY AND FITNESS FOR A PARTICULAR PURPOSE (AND THEIR EQUIVALENTS UNDER THE LAWS OF ANY JURISDICTION).

Diodes Incorporated and its subsidiaries reserve the right to make modifications, enhancements, improvements, corrections or other changes without further notice to this document and any product described herein. Diodes Incorporated does not assume any liability arising out of the application or use of this document or any product described herein; neither does Diodes Incorporated convey any license under its patent or trademark rights, nor the rights of others. Any Customer or user of this document or products described herein in such applications shall assume all risks of such use and will agree to hold Diodes Incorporated and all the companies whose products are represented on Diodes Incorporated website, harmless against all damages.

Diodes Incorporated does not warrant or accept any liability whatsoever in respect of any products purchased through unauthorized sales channel.

Should Customers purchase or use Diodes Incorporated products for any unintended or unauthorized application, Customers shall indemnify and hold Diodes Incorporated and its representatives harmless against all claims, damages, expenses, and attorney fees arising out of, directly or indirectly, any claim of personal injury or death associated with such unintended or unauthorized application.

Products described herein may be covered by one or more United States, international or foreign patents pending. Product names and markings noted herein may also be covered by one or more United States, international or foreign trademarks.

This document is written in English but may be translated into multiple languages for reference. Only the English version of this document is the final and determinative format released by Diodes Incorporated.

LIFE SUPPORT

Diodes Incorporated products are specifically not authorized for use as critical components in life support devices or systems without the express written approval of the Chief Executive Officer of Diodes Incorporated. As used herein:

A. Life support devices or systems are devices or systems which:

1. are intended to implant into the body, or
2. support or sustain life and whose failure to perform when properly used in accordance with instructions for use provided in the labeling can be reasonably expected to result in significant injury to the user.

B. A critical component is any component in a life support device or system whose failure to perform can be reasonably expected to cause the failure of the life support device or to affect its safety or effectiveness.

Customers represent that they have all necessary expertise in the safety and regulatory ramifications of their life support devices or systems, and acknowledge and agree that they are solely responsible for all legal, regulatory and safety-related requirements concerning their products and any use of Diodes Incorporated products in such safety-critical, life support devices or systems, notwithstanding any devices- or systems-related information or support that may be provided by Diodes Incorporated. Further, Customers must fully indemnify Diodes Incorporated and its representatives against any damages arising out of the use of Diodes Incorporated products in such safety-critical, life support devices or systems.

Copyright © 2016, Diodes Incorporated

www.diodes.com