

DESCRIPTION

The AP66200Q is an adjustable switching frequency, internally compensated, synchronous DC-DC Buck converter with a default internal frequency of 500kHz. The device fully integrates a 185mΩ high-side power MOSFET and an 80mΩ low-side power MOSFET to provide highly efficient step-down DC-DC conversion.

The AP66200Q enables continuous load current of up to 2A with as high as 95% efficiency. The device features current

mode control operation, enabling easy loop stabilization, and supports a wide range of output capacitive loads.

With its high level of integration and minimal need for external components, the AP66200Q simplifies board layout and reduces space requirements. This makes it ideal for distributed power architectures.

The AP66200Q is available in the standard Green U-QFN4040-16/SWP (Type UXB) package.

FEATURES

- Qualified for Automotive Applications
- AEC-Q100 Qualified with the Following Results
 - Device Temperature Grade 1: -40°C to +125°C T_A
 - Device HBM ESD Classification Level H1C
 - Device CDM ESD Classification Level C3B
- V_{IN} 3.8 to 60V
- 2A Continuous Output Current
- V_{OUT} Adjustable from 0.8V to 50V
- Enhanced Efficiency Mode with Bias
- Adjustable Switching Frequency. 500kHz Default Frequency
- Start-up with Pre-biased Output
- External Soft-Start with Tracking – Sequential, Ratiometric, or Absolute. Default Internal Soft-Start of 2ms
- Enable Pin with 5% tolerance
- Soft Discharge
- ±5% Power Good Detection with Internal Pull-up Resistor
- Overvoltage Protection and Undervoltage Protection
- Overcurrent Protection (OCP) with Hiccup
- Thermal Protection
- **Totally Lead-Free & Fully RoHS Compliant**
- **Halogen and Antimony Free. “Green” Device**

APPLICATIONS

- General purpose point-of-load DC/DC power conversion
- Automotive infotainments
- Telecommunication
- Distributed power systems
- Home audio
- Consumer electronics
- Network systems
- FPGA, DSP, and ASIC supplies
- Green electronics such as PCs, monitors, televisions, washing machines, refrigerators, microwaves

ABSOLUTE MAXIMUM RATINGS

Symbol	Parameter	Rating	Unit
V _{IN}	Supply Voltage	-0.3 to +72	V
V _{SW}	Switch Node Voltage	-1.0 to V _{IN} +0.3 (DC)	V
V _{SW}	Switch Node Voltage	-2.5 to V _{IN} +2 (ns)	V
V _{EN}	Enable/UVLO Voltage	-0.3V to +72	V
V _{BST}	Bootstrap Voltage	V _{SW} -0.3 to V _{SW} +6.0	V
V _{BIAS}	Bias Voltage	-0.3 to +18	V
V _{CC}	VCC Voltage	-0.3V to +6.0	V
V _{FB}	Feedback Voltage	-0.3V to +6.0	V
V _{FS}	Frequency Adjust	-0.3V to +6.0	V
V _{PG}	Power Good Voltage	-0.3V to +6.0	V
V _{SS/TR}	Soft-start / Tracking	-0.3V to +6.0	V
V _{MSYNC}	Synchronization and MODE	-0.3V to +6.0	V
T _{ST}	Storage Temperature	-65 to +150	°C
T _J	Junction Temperature	+150	°C
T _L	Lead Temperature	+300	°C
ESD Susceptibility			
HBM	Human Body Model	±2500	V
CDM	Charged Device Model	±1500	V

RECOMMENDED OPERATING CONDITIONS

Symbol	Parameter	Min	Max	Unit
V _{IN}	Supply Voltage	3.8	60	V
V _{BIAS}	Supply Voltage	3.8	15	V
T _A	Operating Ambient Temperature Range	-40	+125	°C
T _J	Operating Junction Temperature Range	-40	+150	°C

ORDERING INFORMATION

Orderable Part Number	Package Code	Package	Identification Code	Packing		
				Quantity	Carrier	Part Number Suffix
AP66200QFVBW-13	FVBW	U-QFN4040-16/SWP (Type UXB)	F2Q	3000	Tape and Reel	-13

EVALUATION BOARD

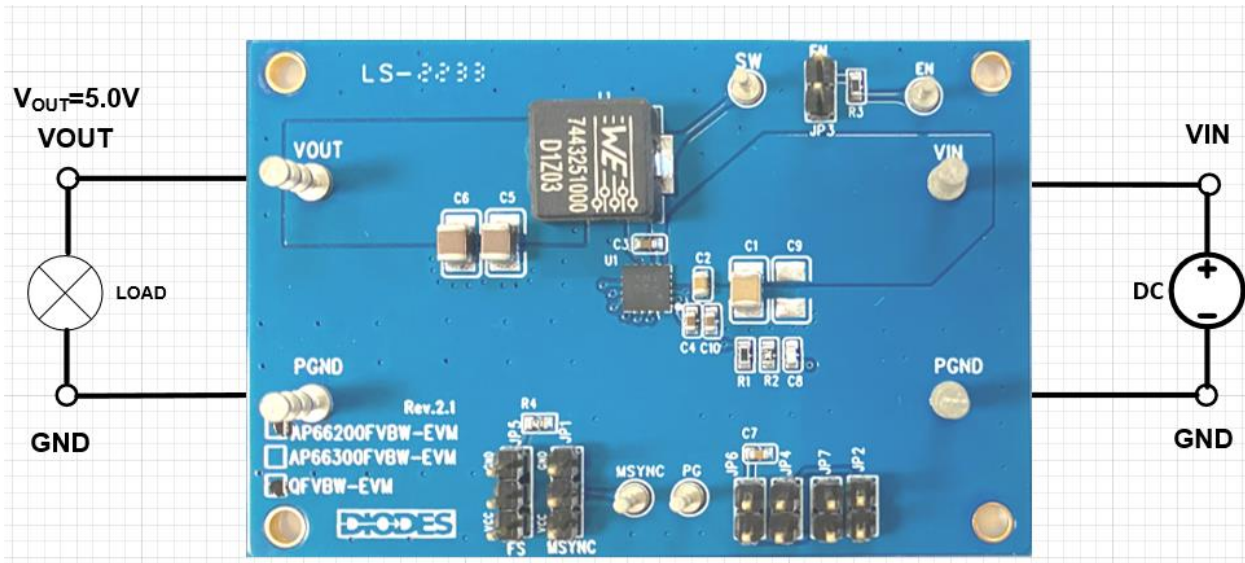

Figure 1. AP66200QFVBW-EVM

QUICK START GUIDE

The AP66200Q EVM board has a simple layout and allows access to the appropriate signals through test points. To evaluate the performance of the AP66200Q, follow the procedure below:

1. Insert jumpers to configure the EVM board setting as described in the Application Information sections of the device datasheet.
2. Use jumper JP3 (100K Ω to VIN) set device enabled.
3. Remove jumpers JP3 and connect external voltage source on EN pin directly.
4. Use jumper JP5 to set FS to default 500KHz (VCC) or 2.5MHz (GND).
5. Use jumper JP1 to set MSYNC to forced PWM (VCC) or PFM (GND) operation.
6. Remove jumper JP1 and force an external clock source on MSYNC pin for synchronization with positive edge trigger and PWM.
7. Use jumper JP6 for default external soft start (C7) of 2ms.
8. Remove jumper JP6 and use jumper JP7 (VCC) for internal soft start of 1.7ms.
9. Use jumper JP4 to connect BIAS pin to PGND.
10. Use jumper JP2 to connect BIAS pin to VOUT.
11. Remove JP2 and JP4 and connect an external voltage source on BIAS pin (<15V).
12. Connect a 12V power supply between the VIN and PGND terminals. Make sure the power supply is turned off.
13. Connect an adjustable current or resistive load to the VOUT and PGND terminals.
14. Turn on the power supply. Do not turn on the power supply until all connections are completed and fully checked.
15. The EVM board should now power up with a 5V output voltage.
16. Increase the load current and observe the output voltage change.
17. Check for the stable operation of the SW and VOUT signal on the oscilloscope.
18. Measure the switching frequency on SW probe jack in the EVM board.
19. Measure the output ripple on the VOUT probe jack in the EVM board.

MEASUREMENT/PERFORMANCE GUIDELINES

When measuring the output voltage ripple, maintain the shortest possible ground lengths on the oscilloscope probe. Long ground leads can erroneously inject high frequency noise into the measured ripple.

EVALUATION BOARD SCHEMATIC

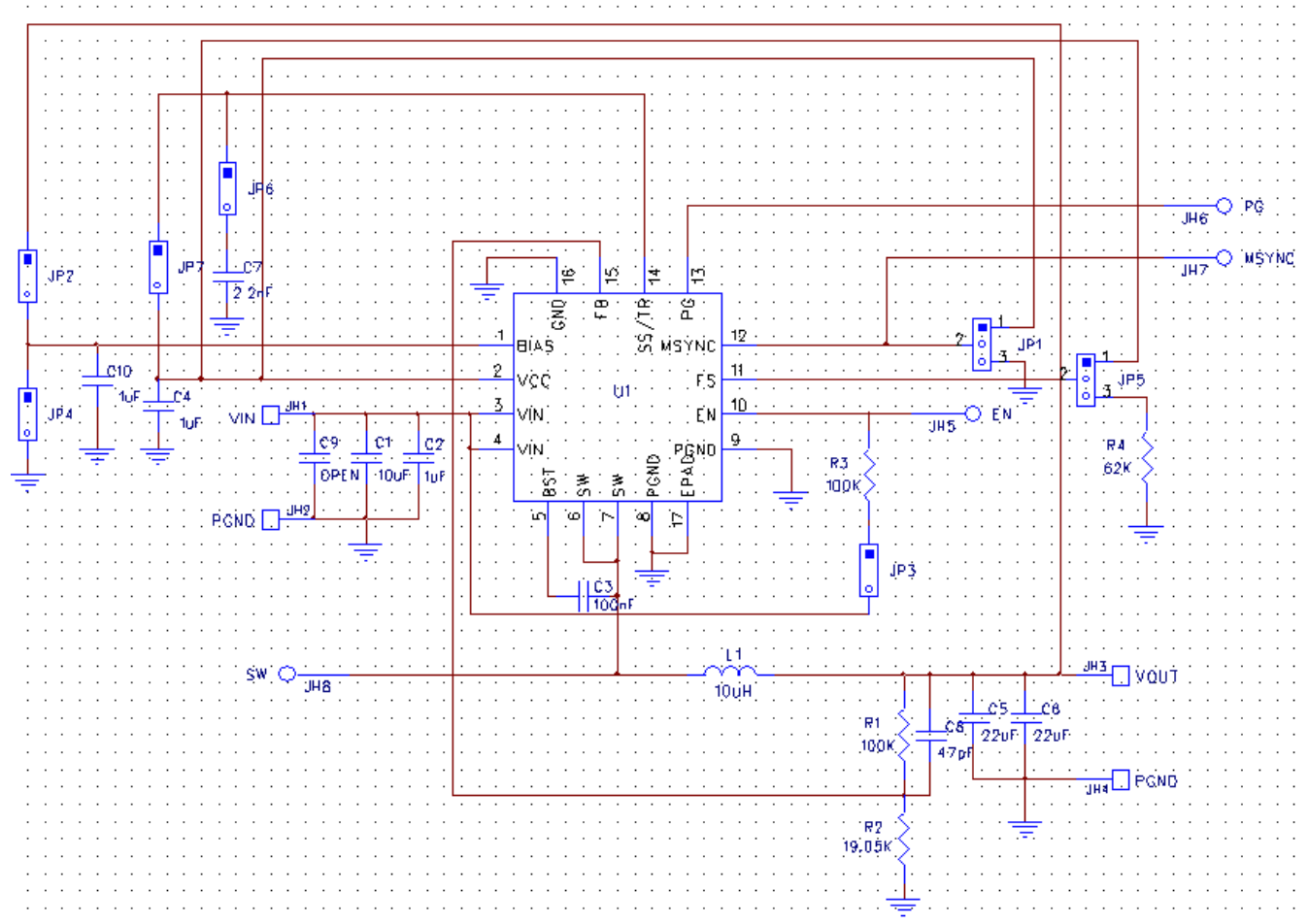

Figure 2. AP66200QFVBW-EVM Schematic

PCB LAYOUT

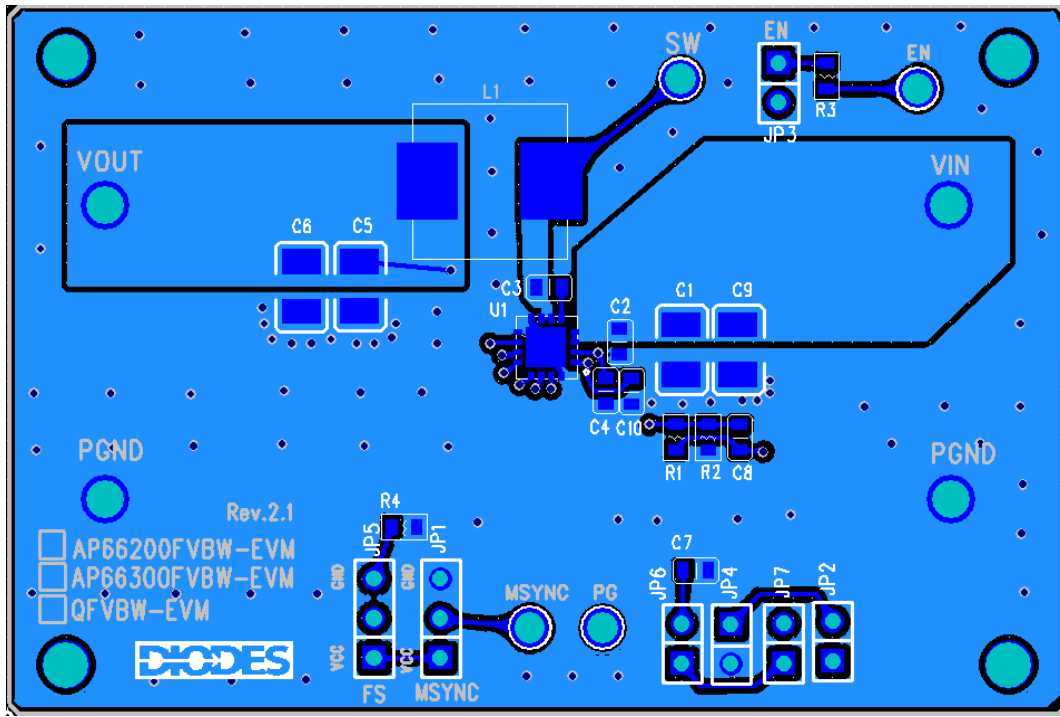

Figure 3. AP66200QFVBW-EVM – Top Layer

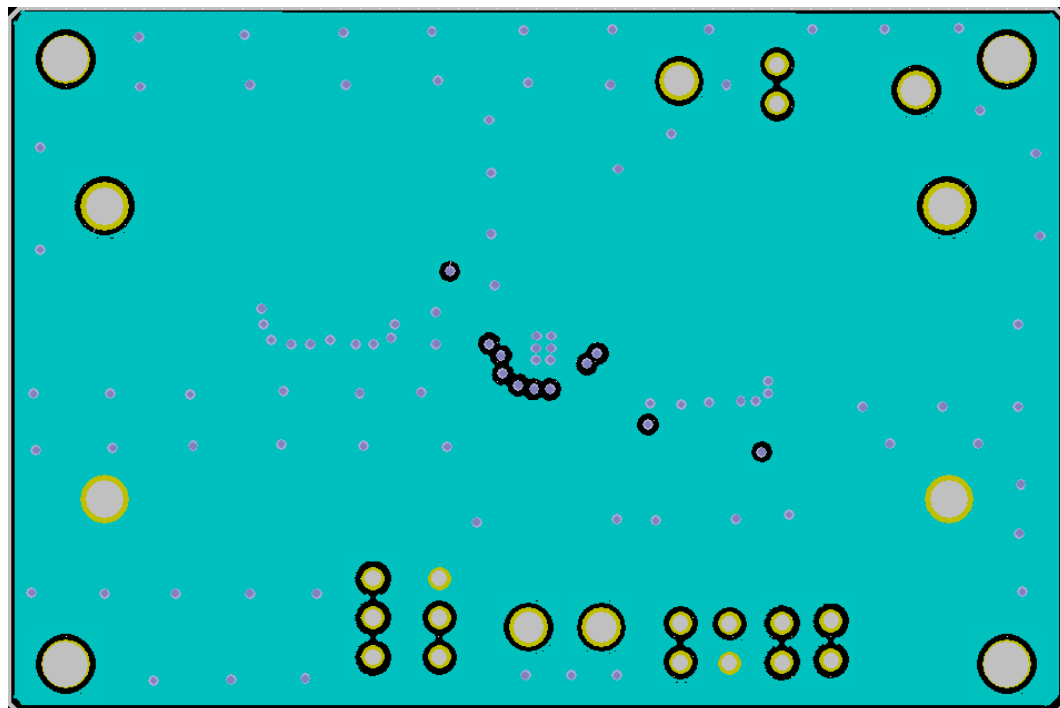

Figure 4. AP66200QFVBW-EVM – Layer 2

PCB LAYOUT (continued)

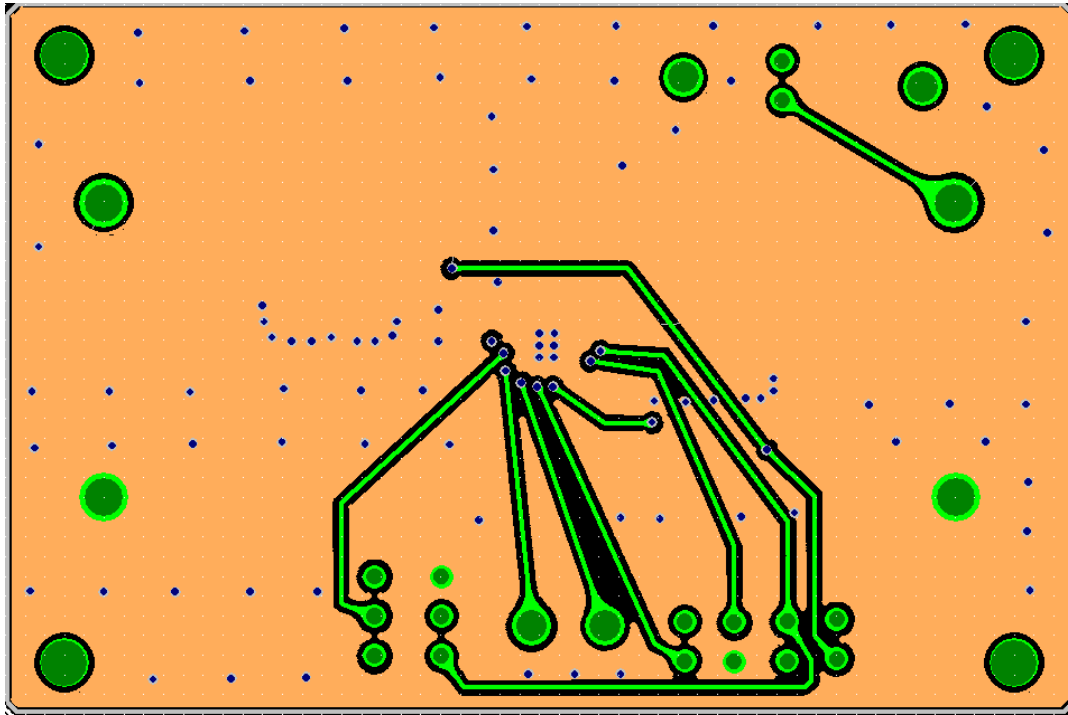

Figure 5. AP66200QFVBW-EVM – Layer 3

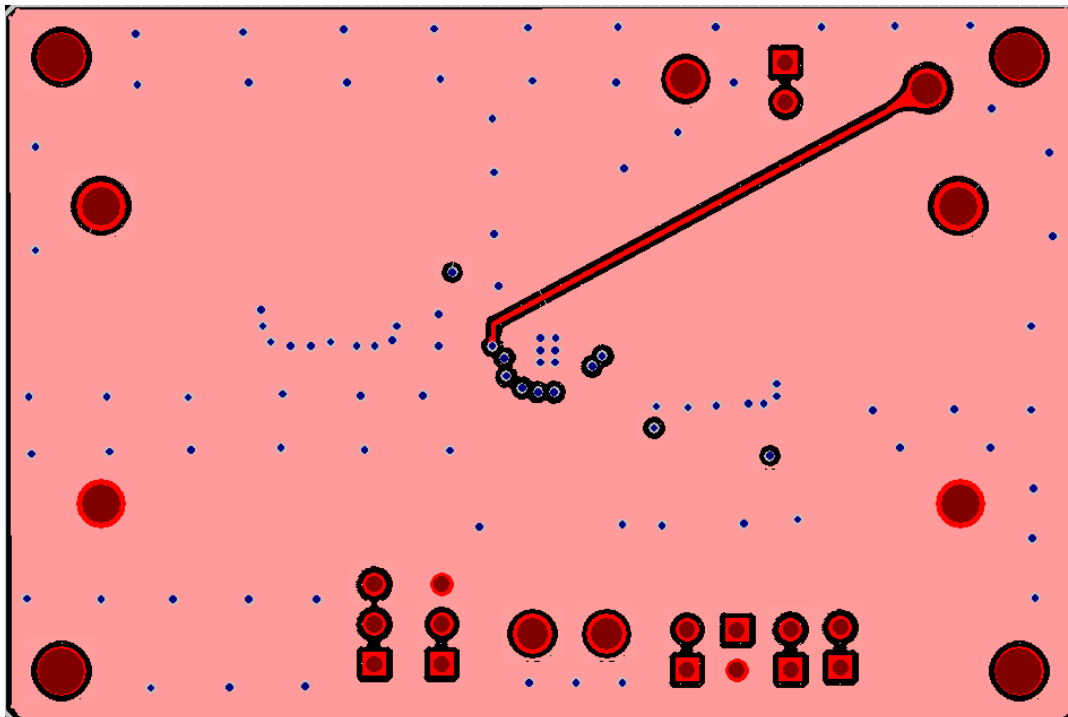

Figure 6. AP66200QFVBW-EVM – Bottom Layer

BILL OF MATERIALS for AP66200Q EVM

Qty	Ref	Value	Description	Package	Manufacturer	Manufacturer P/N
1	C1	10uF	Ceramic Capacitor, 100V	1210	Murata	GRM32EC72A106KE05L
1	C2	1uF	Ceramic Capacitor, 100V, X5R, 20%	0805	Murata	GRJ21BC72A105KE11L
1	C3	100nF	Ceramic Capacitor, 50V, X7R, 10%	0603	TDK	CGA3E2X7R1H104KTOYON
2	C4, C10	1uF	Ceramic Capacitor, 25V, X7R, 10%	0603	Taiyo Yuden	963-TMK107B7105KA-T
2	C5, C6	22uF	Ceramic Capacitor, 25V, X5R	1210	Taiyo Yuden	TMK325BJ226MM-T
1	C7	2.2nF	Ceramic Capacitor, 25V, X7R, 10%	0603	AVX	06033C222KAT2A
1	C8	47pF	Ceramic Capacitor, 100V, X7R, 20%	0603	Kemet	C0603C470K1RACTU
2	R1, R3	100K Ω	Film Resistor	0603	Panasonic	ERJ-3EKF1003V
1	R2	19.1K Ω	Film Resistor	0603	Yageo	AC0603FR-0719K1L
1	R4	62K Ω	Film Resistor	0603	Yageo	AC0603FR-1362KL
1	L1	10uH	DCR=16.3m Ω , Isat=7.2A	10.5x10.5x4.7mm	Würth Electronics	7443251000
5	JP2, 3, 4, 6, 7		PCB Header, 40 POS	1X2	3M	2340-6111TG
2	JP1, 5		PCB Header, 40 POS	1X3	3M	2340-6111TG
4	PG, MSYNC, SW, EN		PCB Turret Terminal, 0.082"	0.082"	Keystone Electronics	1573-2
4	VIN, VOUT, PGNDx2		PCB Turret Terminal, 0.094"X1/16	0.082"	Keystone Electronics	1598-2
1	AP66200Q		IC	U-QFN4040-16	Diodes Inc	AP66200QFVBW

TYPICAL PERFORMANCE CHARACTERISTICS

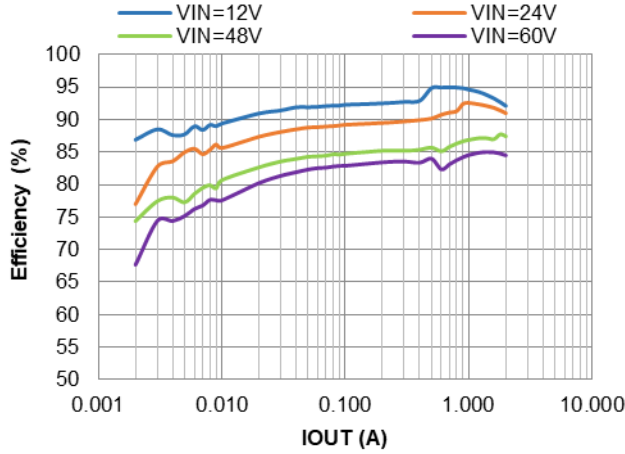

Figure 7. PFM Efficiency vs. IOU, $V_{out}=5V$, $L=10\mu H$

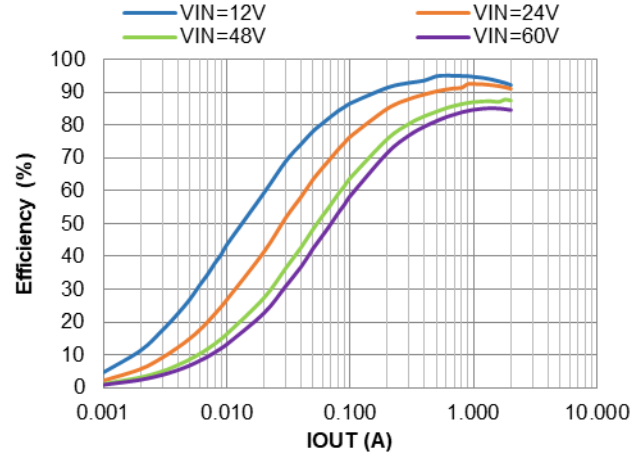

Figure 8. PWM Efficiency vs. IOU, $V_{out}=5V$, $L=10\mu H$

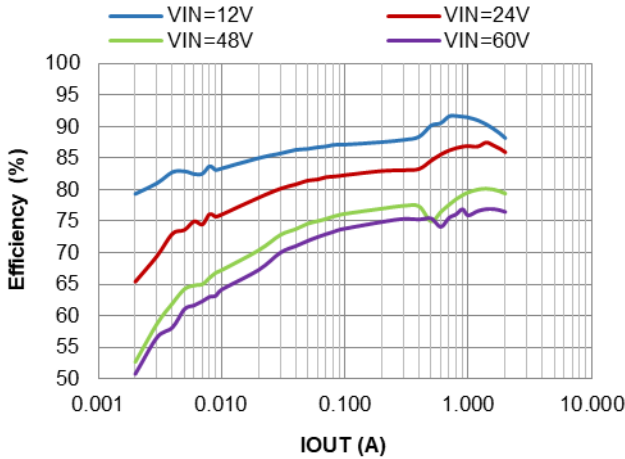

Figure 9. PFM Efficiency vs. IOU, $V_{out}=3.3V$, $L=8.2\mu H$

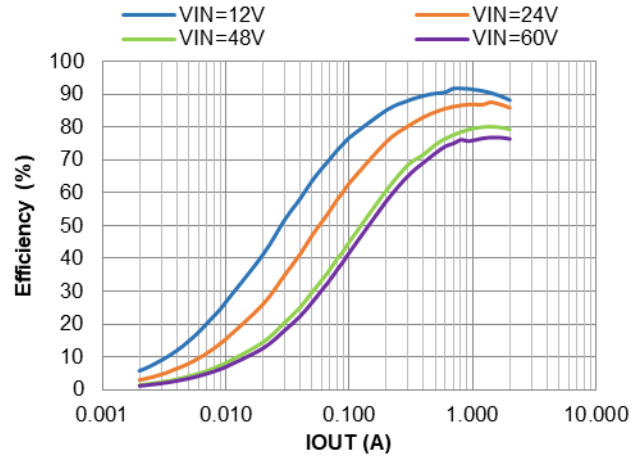

Figure 10. PWM Efficiency vs. IOU, $V_{out}=3.3V$, $L=8.2\mu H$

IMPORTANT NOTICE

1. DIODES INCORPORATED (Diodes) AND ITS SUBSIDIARIES MAKE NO WARRANTY OF ANY KIND, EXPRESS OR IMPLIED, WITH REGARDS TO ANY INFORMATION CONTAINED IN THIS DOCUMENT, INCLUDING, BUT NOT LIMITED TO, THE IMPLIED WARRANTIES OF MERCHANTABILITY, FITNESS FOR A PARTICULAR PURPOSE OR NON-INFRINGEMENT OF THIRD PARTY INTELLECTUAL PROPERTY RIGHTS (AND THEIR EQUIVALENTS UNDER THE LAWS OF ANY JURISDICTION).
2. The Information contained herein is for informational purpose only and is provided only to illustrate the operation of Diodes' products described herein and application examples. Diodes does not assume any liability arising out of the application or use of this document or any product described herein. This document is intended for skilled and technically trained engineering customers and users who design with Diodes' products. Diodes' products may be used to facilitate safety-related applications; however, in all instances customers and users are responsible for (a) selecting the appropriate Diodes products for their applications, (b) evaluating the suitability of Diodes' products for their intended applications, (c) ensuring their applications, which incorporate Diodes' products, comply the applicable legal and regulatory requirements as well as safety and functional-safety related standards, and (d) ensuring they design with appropriate safeguards (including testing, validation, quality control techniques, redundancy, malfunction prevention, and appropriate treatment for aging degradation) to minimize the risks associated with their applications.
3. Diodes assumes no liability for any application-related information, support, assistance or feedback that may be provided by Diodes from time to time. Any customer or user of this document or products described herein will assume all risks and liabilities associated with such use, and will hold Diodes and all companies whose products are represented herein or on Diodes' websites, harmless against all damages and liabilities.
4. Products described herein may be covered by one or more United States, international or foreign patents and pending patent applications. Product names and markings noted herein may also be covered by one or more United States, international or foreign trademarks and trademark applications. Diodes does not convey any license under any of its intellectual property rights or the rights of any third parties (including third parties whose products and services may be described in this document or on Diodes' website) under this document.
5. Diodes' products are provided subject to Diodes' Standard Terms and Conditions of Sale (<https://www.diodes.com/about/company/terms-and-conditions/terms-and-conditions-of-sales/>) or other applicable terms. This document does not alter or expand the applicable warranties provided by Diodes. Diodes does not warrant or accept any liability whatsoever in respect of any products purchased through unauthorized sales channel.
6. Diodes' products and technology may not be used for or incorporated into any products or systems whose manufacture, use or sale is prohibited under any applicable laws and regulations. Should customers or users use Diodes' products in contravention of any applicable laws or regulations, or for any unintended or unauthorized application, customers and users will (a) be solely responsible for any damages, losses or penalties arising in connection therewith or as a result thereof, and (b) indemnify and hold Diodes and its representatives and agents harmless against any and all claims, damages, expenses, and attorney fees arising out of, directly or indirectly, any claim relating to any noncompliance with the applicable laws and regulations, as well as any unintended or unauthorized application.
7. While efforts have been made to ensure the information contained in this document is accurate, complete and current, it may contain technical inaccuracies, omissions and typographical errors. Diodes does not warrant that information contained in this document is error-free and Diodes is under no obligation to update or otherwise correct this information. Notwithstanding the foregoing, Diodes reserves the right to make modifications, enhancements, improvements, corrections or other changes without further notice to this document and any product described herein. This document is written in English but may be translated into multiple languages for reference. Only the English version of this document is the final and determinative format released by Diodes.
8. Any unauthorized copying, modification, distribution, transmission, display or other use of this document (or any portion hereof) is prohibited. Diodes assumes no responsibility for any losses incurred by the customers or users or any third parties arising from any such unauthorized use.
9. This Notice may be periodically updated with the most recent version available at <https://www.diodes.com/about/company/terms-and-conditions/important-notice>

The Diodes logo is a registered trademark of Diodes Incorporated in the United States and other countries.
All other trademarks are the property of their respective owners.
© 2024 Diodes Incorporated. All Rights Reserved.

www.diodes.com