

DESCRIPTION

AP64102 is a 1A, synchronous buck converter with a wide input voltage range of 3.8V to 40V. The device fully integrates a 150mΩ high-side power MOSFET and a 80mΩ low-side power MOSFET to provide high-efficiency step-down DC-DC conversion.

The AP64102 device is easily used by minimizing the external component count due to its adoption of peak current mode control along with its integrated loop compensation network.

The AP64102 design is optimized for Electromagnetic Interference (EMI) reduction. The device has a proprietary gate

driver scheme to resist switching node ringing without sacrificing MOSFET turn-on and turn-off times, which reduces high-frequency radiated EMI noise caused by MOSFET switching. The AP64102 also features Frequency Spread Spectrum (FSS) with a switching frequency jitter of $\pm 6\%$, which reduces EMI by not allowing emitted energy to stay in any one frequency for a significant period of time.

The device is available in an SO-8EP package.

FEATURES

- Wide Input Range: 3.8V to 40V
- 1A Continuous Output Current
- 0.8V $\pm 1\%$ Reference Voltage
- 25 μ A Ultralow Quiescent Current (Pulse Frequency Modulation)
- Adjustable Switching Frequency: 100kHz to 2.2MHz
- External Clock Synchronization: 100kHz to 2.2MHz
- Adjustable Soft-Start Time
- Proprietary Gate Driver Design for Best EMI Reduction
- Frequency Spread Spectrum (FSS) to Reduce EMI
- Low-Dropout (LDO) Mode
- Precision Enable Threshold to adjust UVLO
- Protection Circuitry
 - Undervoltage Lockout (UVLO)
 - Output Overvoltage Protection (OVP)
 - Cycle-by-Cycle Peak Current Limit
 - Thermal Shutdown
- **Totally Lead-Free & Fully RoHS Compliant**
- **Halogen and Antimony Free. “Green” Device**

APPLICATIONS

- Distributed Power Bus Supplies
- Power Tools and Laser Printers
- White Goods and Small Home Appliances
- Home Audio
- Network Systems
- Consumer Electronics
- General Purpose Point of Load

ABSOLUTE MAXIMUM RATINGS

Symbol	Parameter	Rating	Unit
VIN	Supply Pin Voltage	-0.3 to +42.0 (DC)	V
		-0.3 to +45.0 (400ms)	
V _{BST}	Bootstrap Pin Voltage	V _{SW} - 0.3 to V _{SW} + 6.0	V
V _{EN}	Enable/UVLO Pin Voltage	-0.3 to +42.0	V
V _{RT/CLK}	RT/CLK Pin Voltage	-0.3 to +6.0	V
V _{FB}	Feedback Voltage	-0.3V to +6.0	V
V _{SS}	Soft-Start Pin Voltage	-0.3 to +6.0	V
V _{SW}	Switch Node Voltage	-0.3 to VIN + 0.3 (DC)	V
		-2.5 to VIN + 2.0 (20ns)	
T _J	Junction Temperature	+160	°C
T _L	Lead Temperature	+260	°C

RECOMMENDED OPERATING CONDITIONS

Symbol	Parameter	Min	Max	Unit
VIN	Supply Voltage	3.8	40	V
VOUT	Output Voltage	0.8	39	V
T _A	Operating Ambient Temperature Range	-40	+85	°C
T _J	Operating Junction Temperature Range	-40	+125	°C

EVALUATION BOARD

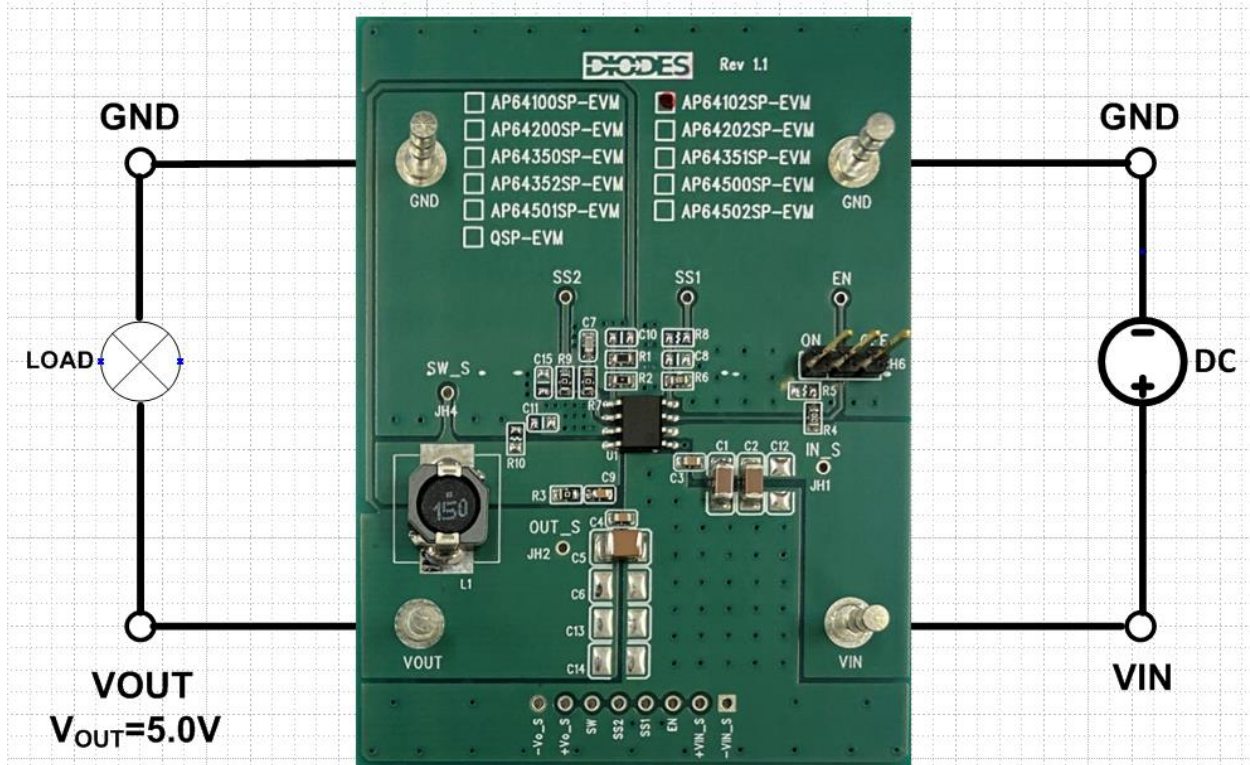

Figure 1. AP64102SP-EVM

QUICK START GUIDE

The AP64102SP-EVM has a simple layout and allows access to the appropriate signals through test points. To evaluate the performance of the AP64102SP, follow the procedure below:

1. Connect a power supply to the input terminals V_{IN} and GND. Set V_{IN} to 12V.
2. Connect the positive terminal of the electronic load to V_{OUT} and negative terminal to GND.
3. For Enable, to enable IC, place a jumper at JH6 to "ON" position to connect EN pin to V_{IN} through 100K Ω resistor or leave it OPEN. Jump to "OFF" position to disable IC.
4. The evaluation board should now power up with a 5.0V output voltage.
5. Check for the proper output voltage of 5.0V ($\pm 1\%$) at the output terminals V_{OUT} and GND. Measurement can also be done with a multimeter with the positive and negative leads between V_{OUT} and GND.
6. Set the load to 1A through the electronic load. Check for the stable operation of the SW signal on the oscilloscope. Measure the switching frequency.

MEASUREMENT/PERFORMANCE GUIDELINES:

- 1) When measuring the output voltage ripple, maintain the shortest possible ground lengths on the oscilloscope probe. Long ground leads can erroneously inject high frequency noise into the measured ripple.
- 2) For efficiency measurements, connect an ammeter in series with the input supply to measure the input current. Connect an electronic load to the output for output current.

SETTING OUTPUT VOLTAGE:

Table 1 shows a list of recommended component selections for common output voltages.

VOUT	R1	R2	L1	C1, C2	C5
1.2V	4.99KΩ	10KΩ	6.8μH	2x10μF	22μF
1.5V	8.66KΩ	10KΩ	8.2μH	2x10μF	22μF
1.8V	12.4KΩ	10KΩ	10μH	2x10μF	22μF
2.5V	21.5KΩ	10KΩ	10μH	2x10μF	22μF
3.3V	31.6KΩ	10KΩ	15μH	2x10μF	22μF
5.0V	52.3KΩ	10KΩ	15μH	2x10μF	22μF
12V	140KΩ	10KΩ	33μH	2x10μF	22μF

Table 1. Common Output Voltages

EVALUATION BOARD SCHEMATIC

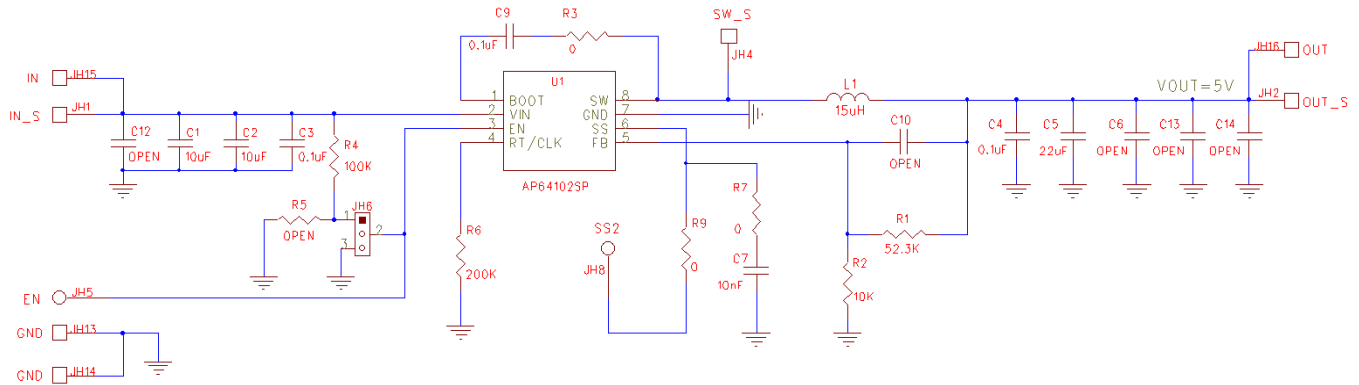

Figure 2. AP64102SP-EVM Schematic

PCB TOP LAYOUT

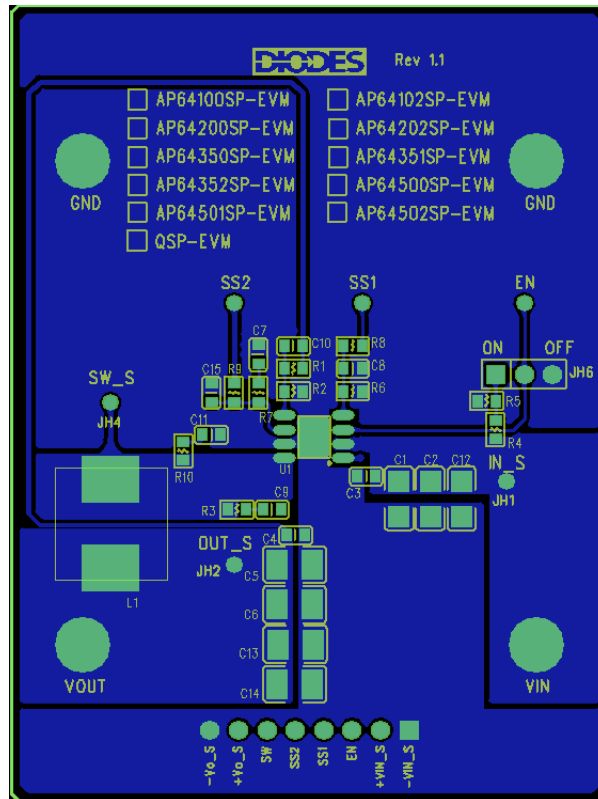

Figure 3. AP64102SP-EVM – Top Layer

PCB BOTTOM LAYOUT

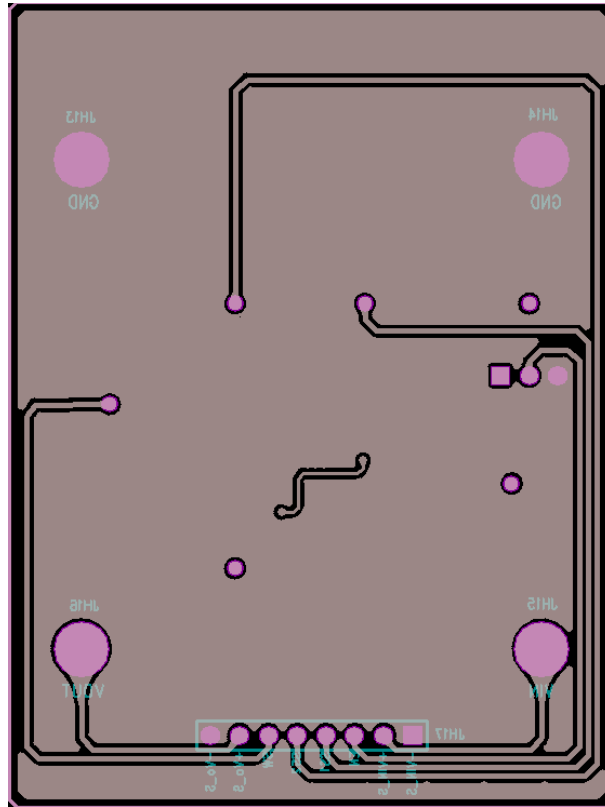

Figure 4. AP64102SP-EVM – Bottom Layer

BILL OF MATERIALS for AP64102SP-EVM for $V_{OUT}=5V$

Ref	Value	Description	Qty	Size	Vendor Name	Manufacturer PN
C1, C2	10 μ F	Ceramic Capacitor, 50V, X7R, 10%	2	1206	Samsung	CL31B106KBHNNNE
C3, C4, C9	0.1 μ F	Ceramic Capacitor, 50V, X7R, 10%	3	0603	Würth Electronics	885012206095
C5	22 μ F	Ceramic Capacitor, 16V, X7R	1	1210	Samsung	CL32B226KOJNNNE
C7	10nF	Ceramic Capacitor, 50V, X7R	1	0603	Würth Electronics	885382206002
R1	52.3K Ω	SMD Resistor, 1%	1	0603	Panasonic	ERJ-3EKF5232V
R2	10K Ω	SMD Resistor, 1%	1	0603	Panasonic	ERJ-3EKF1002V
R3, R7, R9	0 Ω	SMD Resistor, 1%	3	0603	Panasonic	ERJ-3GEY0R00V
R4	100K Ω	SMD Resistor, 1%	1	0603	Panasonic	ERJ-3EKF1003V
R6	200K Ω	SMD Resistor, 1%	1	0603	Panasonic	ERJ-S03F2003V
L1	15 μ H	DCR=69.5m Ω , Ir=2.2A	1	7.4x 7.3x 4.5mm	Würth Electronics	7447773150
JH6		PCB Header, 36 POS	1	1X3	Amphenol	78511-136HLF
JH1 3, JH1 4, JH1 5, JH1 6	1598	Terminal Turret Triple 0.094" L (Test Points)	4	Through-Hole	Keystone Electronics	1598-2
U1	AP64102	Sync DC-DC Converter	1	SO-8EP	Diodes Incorporated (Diodess0)	AP64102SP

TYPICAL PERFORMANCE CHARACTERISTICS

Figure 5. Efficiency vs Output Current

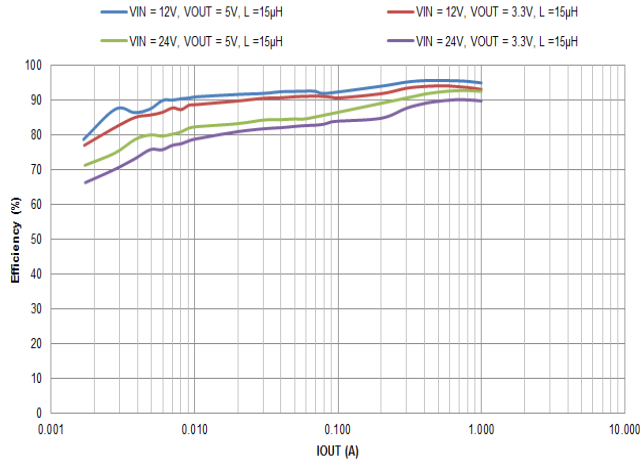

Figure 6. Load Transient 0.5A to 1A

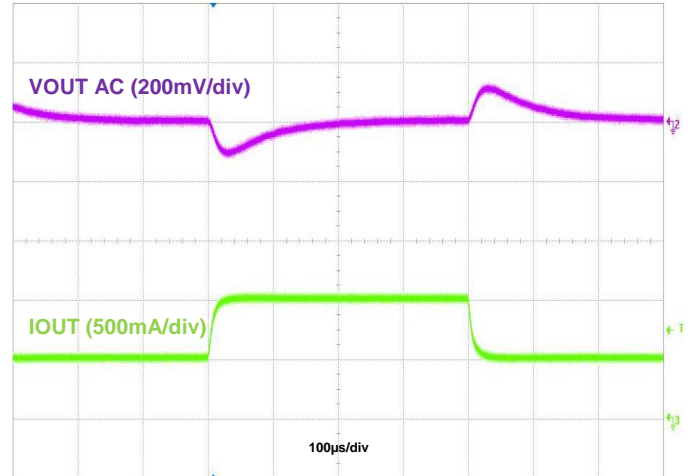

Figure 7. Output Voltage Ripple, IOUT=1A

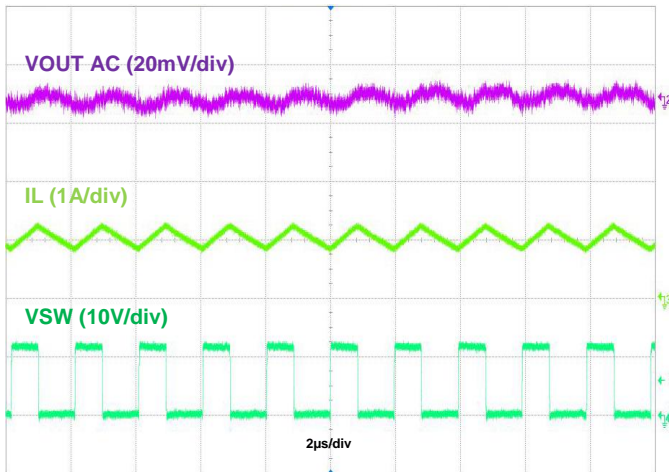
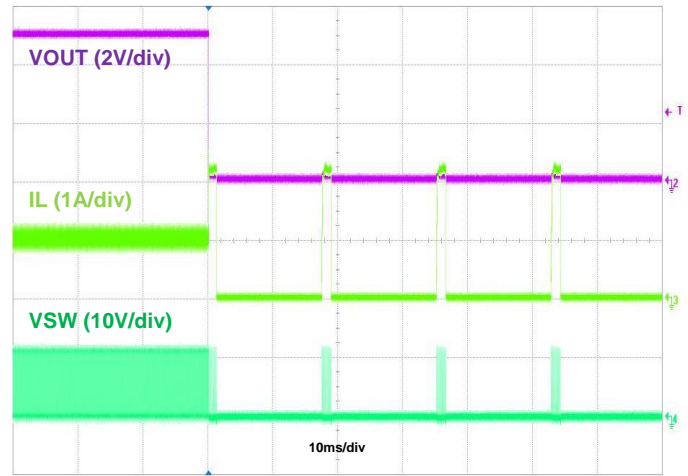

Figure 8. Output Short Protection, IOUT=1A



IMPORTANT NOTICE

1. DIODES INCORPORATED (Diodes) AND ITS SUBSIDIARIES MAKE NO WARRANTY OF ANY KIND, EXPRESS OR IMPLIED, WITH REGARDS TO ANY INFORMATION CONTAINED IN THIS DOCUMENT, INCLUDING, BUT NOT LIMITED TO, THE IMPLIED WARRANTIES OF MERCHANTABILITY, FITNESS FOR A PARTICULAR PURPOSE OR NON-INFRINGEMENT OF THIRD PARTY INTELLECTUAL PROPERTY RIGHTS (AND THEIR EQUIVALENTS UNDER THE LAWS OF ANY JURISDICTION).
2. The Information contained herein is for informational purpose only and is provided only to illustrate the operation of Diodes' products described herein and application examples. Diodes does not assume any liability arising out of the application or use of this document or any product described herein. This document is intended for skilled and technically trained engineering customers and users who design with Diodes' products. Diodes' products may be used to facilitate safety-related applications; however, in all instances customers and users are responsible for (a) selecting the appropriate Diodes products for their applications, (b) evaluating the suitability of Diodes' products for their intended applications, (c) ensuring their applications, which incorporate Diodes' products, comply the applicable legal and regulatory requirements as well as safety and functional-safety related standards, and (d) ensuring they design with appropriate safeguards (including testing, validation, quality control techniques, redundancy, malfunction prevention, and appropriate treatment for aging degradation) to minimize the risks associated with their applications.
3. Diodes assumes no liability for any application-related information, support, assistance or feedback that may be provided by Diodes from time to time. Any customer or user of this document or products described herein will assume all risks and liabilities associated with such use, and will hold Diodes and all companies whose products are represented herein or on Diodes' websites, harmless against all damages and liabilities.
4. Products described herein may be covered by one or more United States, international or foreign patents and pending patent applications. Product names and markings noted herein may also be covered by one or more United States, international or foreign trademarks and trademark applications. Diodes does not convey any license under any of its intellectual property rights or the rights of any third parties (including third parties whose products and services may be described in this document or on Diodes' website) under this document.
5. Diodes' products are provided subject to Diodes' Standard Terms and Conditions of Sale (<https://www.diodes.com/about/company/terms-and-conditions/terms-and-conditions-of-sales/>) or other applicable terms. This document does not alter or expand the applicable warranties provided by Diodes. Diodes does not warrant or accept any liability whatsoever in respect of any products purchased through unauthorized sales channel.
6. Diodes' products and technology may not be used for or incorporated into any products or systems whose manufacture, use or sale is prohibited under any applicable laws and regulations. Should customers or users use Diodes' products in contravention of any applicable laws or regulations, or for any unintended or unauthorized application, customers and users will (a) be solely responsible for any damages, losses or penalties arising in connection therewith or as a result thereof, and (b) indemnify and hold Diodes and its representatives and agents harmless against any and all claims, damages, expenses, and attorney fees arising out of, directly or indirectly, any claim relating to any noncompliance with the applicable laws and regulations, as well as any unintended or unauthorized application.
7. While efforts have been made to ensure the information contained in this document is accurate, complete and current, it may contain technical inaccuracies, omissions and typographical errors. Diodes does not warrant that information contained in this document is error-free and Diodes is under no obligation to update or otherwise correct this information. Notwithstanding the foregoing, Diodes reserves the right to make modifications, enhancements, improvements, corrections or other changes without further notice to this document and any product described herein. This document is written in English but may be translated into multiple languages for reference. Only the English version of this document is the final and determinative format released by Diodes.
8. Any unauthorized copying, modification, distribution, transmission, display or other use of this document (or any portion hereof) is prohibited. Diodes assumes no responsibility for any losses incurred by the customers or users or any third parties arising from any such unauthorized use.
9. This Notice may be periodically updated with the most recent version available at <https://www.diodes.com/about/company/terms-and-conditions/important-notice>

The Diodes logo is a registered trademark of Diodes Incorporated in the United States and other countries.
All other trademarks are the property of their respective owners.
© 2024 Diodes Incorporated. All Rights Reserved.

www.diodes.com