

General Description

Based on Flyback topology, the Primary side Regulated AP3981D2 EV board is designed to serve as an example for High Efficiency, low cost & less components consumer home appliance systems. Also a 650V N MosFet is integrated within control IC for easy fitting in a flexible & small size power system design. During the valley on operating & work at PFM region the high efficiency and low standby function can be achieved, by mean of using multi-mode controlling skill the accurate constant voltage and constant current can be easy meet. Its output power is rated at 12W with 12V-1A. It can meet DOE VI and CoC Tier 2 energy efficiency requirement.

Key Features

- 90 ~264V_{AC} input range
- Using the Primary side control for eliminating the Opto-coupler.
- Multi-Mode PFM method operations, the switching frequency between 24kh ~80Khz.
- With Valley on detection the switching stay at Valley on region so that will improve power converting efficiency & EMI performance, the 87% Efficiency can be reached at full load.
- During the burst mode operation and Low start-up operating quiescent currents the 75mW low standby input power can be achieved.
- Dynamic response is improved during work at three mode operation as well as benefiting the accurate constant voltage (CV) regulation & constant current (CC) performance.
- There is a Soft start during startup process.
- Built-in Jittering Frequency function which is the EMI emission can be improved.
- Internal Auto Recovery OCP, OVP, OLP, OTP Power Protection, cycle by cycle current limit, also with DC polarity protection
- Built –in Cable Compensation mode.
- With a Brown out Protection.

Applications

- Switching AC-DC Adaptor & Charger
- Power home Appliances systems
- The auxiliary Vcc power supply for bigger power system.

Universal AC input PSR 12V-1.0A Power Specifications (CV & CC mode)

Parameter	Value
Input Voltage	90 to 264V _{AC}
Input standby power	75mW
Main output Vo / Io	12V – 1A
Efficiency	~ 86%
Total Output Power	12W
Protections	OCP, OVP, OLP, OTP
XYZ Dimension	63 x 34 x 20 mm
ROHS Compliance	Yes

Evaluation Board Picture:

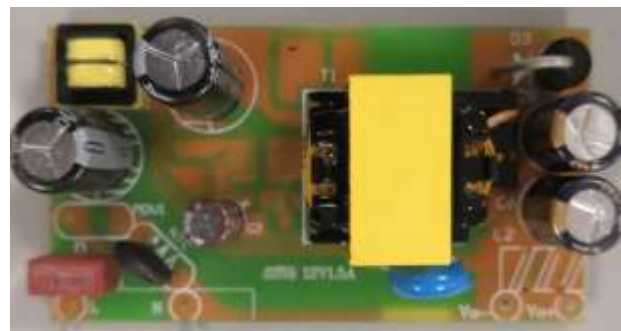

Figure 1: Top View

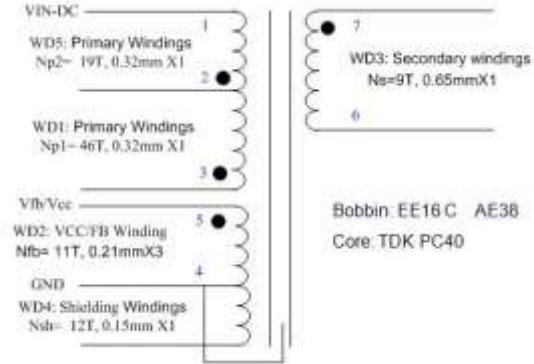
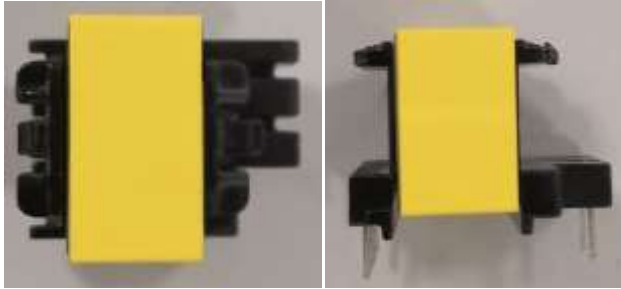

Figure 2: Bottom View

AP3981D2 (90V_{AC} ~ 265V_{AC} one outputs 12W Transformer Spec.)

1) Core & Bobbin: EE16C , 5+2 pin

2) Electrical Diagram:



3) Transformer Parameters

1. Primary Inductance (Pin1-Pin3), all other windings are open $L_p = 1 \text{ mH} \pm 7\% @ 10\text{KHz}$

EE16C (Ae = 38mm ²)						
NO Winding	NAME	TERMINAL NO.		WINDING		
		START	FINISH	WIRE	TURNS	Layers
1	Na	5	4	Φ 0.21mm X 3	11 Ts	1
2	Np1	3	2	Φ 0.32mm X 1	46 Ts	2
3	Shield	4 (GND)	NC	Φ 0.15mm X 1	12 Ts	1
4	Ns	7	6	Φ 0.65W X 1	9 Ts	1
5	Np2	2	1	Φ 0.32mm X 1	19 Ts	1
Primary Inductance		Pin 1-3, all other windings open, measured at 10kHz, 0.4VRMS			1mH ± 7 %	
Primary Leakage Inductance		Pin 1-3, all other windings shorted, measured at 10kHz, 0.4VRMS			80 uH (Max.)	

Evaluation Board Schematic

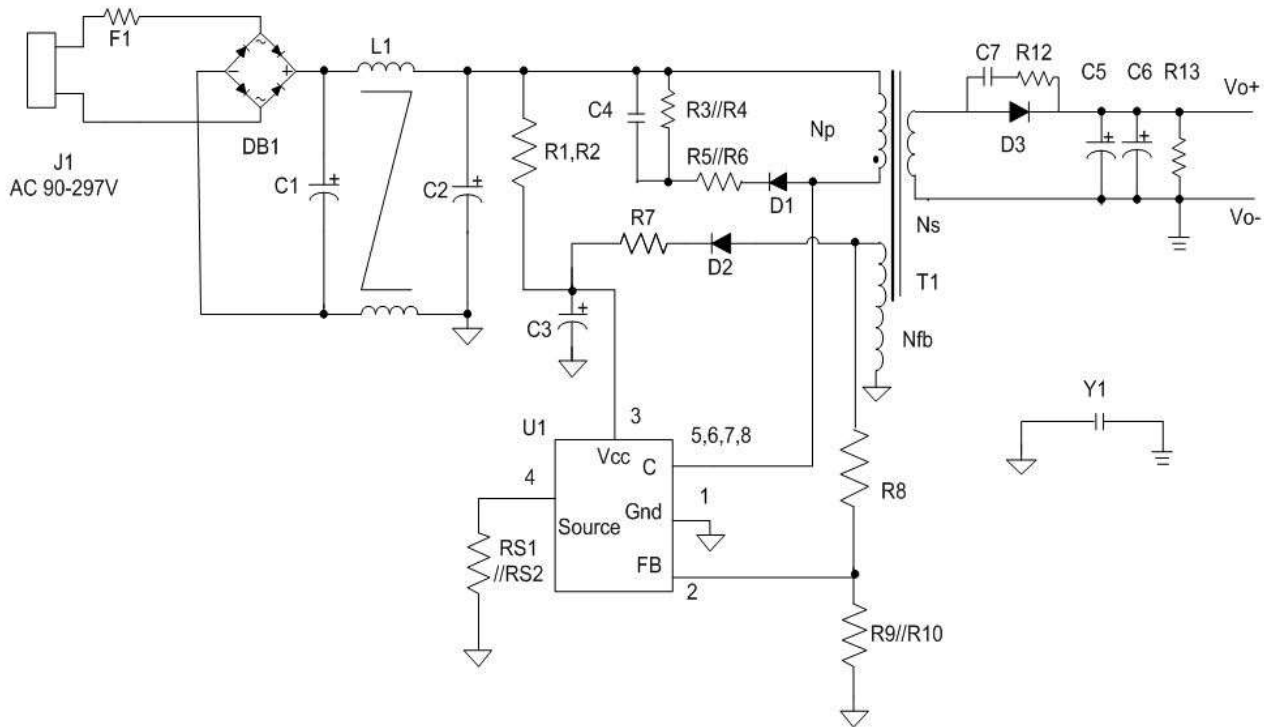

Figure 3: Evaluation Board Schematic

Evaluation Board PCB Layout

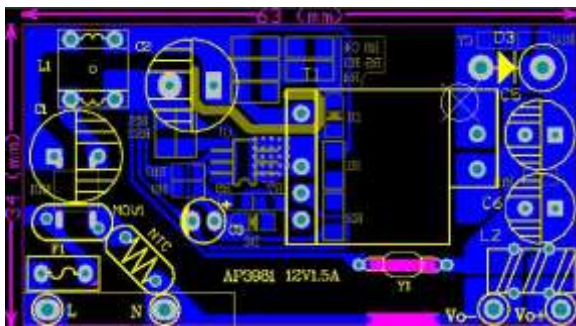

Figure4: PCB Board Layout Top View

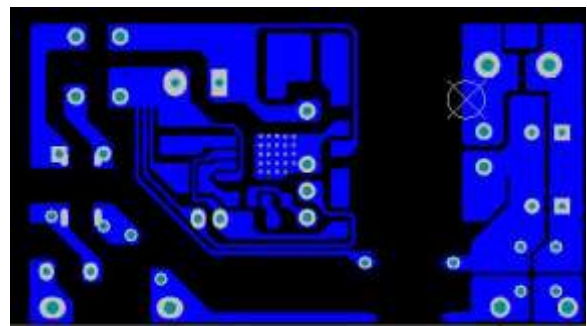

Figure5: PCB Board Layout Bottom View

Quick Start Guide

1. The evaluation board is preset at 12V/1A from output + & -
2. Ensure that the AC source is switched OFF or disconnected before doing connection.
3. Connect the AC line wires of power supply to “L and N” on the left side of the board.
4. Turn on the AC main switch.
5. Measure Red & Black wires to ensure correct output voltages at 12V respectively.

Build of Material

AP3981D2 12V-1A BOM 8-28-2018

Item	QTY per board	REF. DES.	Description	MFG or Supplier	MFG P/N or Supplier P/N Digi key #
1	1	C1	10uf /400V 8 x 18mm	Aishi Electro	
2	1	C2	10uf /400V 8 x 18mm	Aishi Electro	
3	1	C3	4.7uF/50V 5 x 10mm	Aishi Electro	
4	1	C4	470pf / 200V, 0805 X7R	Holy Stone	
5	1	C5	470uf /16V 8 x 12mm	Rubycon Electro	
6	1	C6	470uf /16V 8 x 12mm	Rubycon Electro	
7	1	C7	470pf / 200V, 0805 X7R	Holy Stone	
8	1	R1	1.6M ohm 1206	Yageo	
9	1	R2	1.6M ohm 1206	Yageo	
10	1	R3	360K ohm 1206	Yageo	
11	1	R4	360K ohm 1206	Yageo	
12	1	R5	300R ohm 1206	Yageo	
13	1	R6	300R ohm 1206	Yageo	
14	1	R7	2.7R ohm 0805	Yageo	
15	1	R8	30.1K ohm 0805	Yageo	
16	1	R9	6.19K ohm 0805	Yageo	
17	1	R10	300K ohm 0805	Yageo	
18	1	RS1	1.8R ohm 1206	Yageo	
19	1	RS2	1.8R ohm 1206	Yageo	
20	1	R12	20R ohm 0805	Yageo	
21	1	R13	12K ohm 1206	Yageo	
22	1	BD1	ABS10 SOPA-4	Diodes	
23	1	D1	1N4007 or S1MWF 1KV/1A SOD-123	Diodes	
24	1	D2	FR107 or RS1MSWF 1KV/1A SOD-123	Diodes	
25	1	D3	SDT5H100SB or SR5100L100V-5A	Diodes or JF	
26	1	F1	2A	Fuse	
27	1	L1	10mH EE8.3	Inductor	
28	1	Y1	470pf/250Vac Y1	Holy Stone	
29	1	U1	AP3981D2 sop-8	Diodes	
30	1	T1	EE16 Wider Core & Bobbin YTX-1622	Yang Tong Electronical	

Notes: 1.D1& D2 diode type selection, we propose D1standard or D2 fast diode (not SchottKy or super-fast recovery diode).
2, T1 EE16 YTX-1622 from here: http://www.dgtydz.com/products_content-1557266.html

Input Standby Power

Input Voltage	115Vac/60Hz	230Vac/50Hz	Note
Pin (w)	34mW	64mW	At no loading

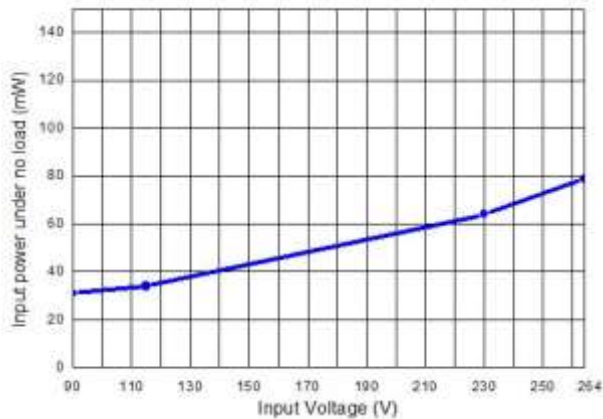

Figure 6: The Efficiency curve with at different AC input

Input power Efficiency at different loading

AC input	Efficiency (%)					Eff_avg at four conditions
	10%	25%	50%	75%	100%	
90VAC/60Hz						
115VAC/60Hz	84.01%	86.42%	86.85%	87.13%	87.24%	86.91%
230VAC/50Hz	80.08%	85.24%	86.56%	87.28%	87.62%	86.67%
264VAC/50Hz						
Eff_avg						

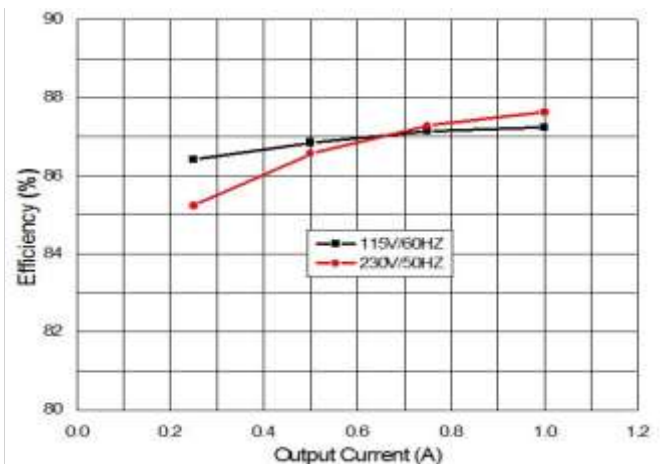

Figure 7: The efficiency curve with different loading

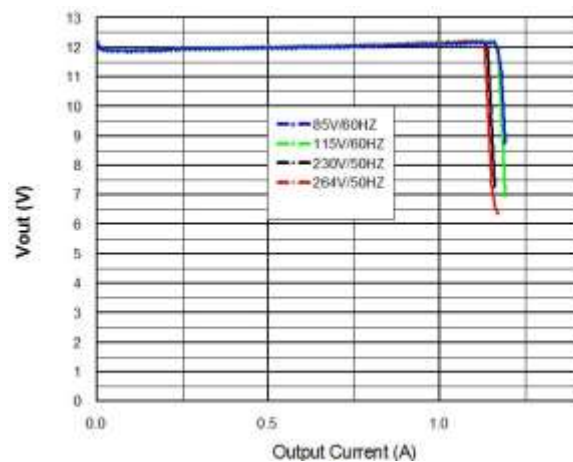

Figure 8: CV & CC Curve at OCP set poits

OCP Current set point with at different AC line

AC input	90VAC	115VAC	230VAC	264VAC	Note
I_max	1.19 A	1.18A	1.16A	1.16A	

PSU Output Characteristics:

Line Regulation (at full loading condition):

AC input Voltage	90VAC/60Hz	115VAC/60Hz	230VAC/50Hz	265VAC/50Hz	Note
12.00Vo	12.27V/1A	12.29V/1A	12.33V/1A	12.34V/1A	0.58%<1%

Cross Load Regulation (at nominal line AC input voltage):

AC input Voltage	115VAC/60Hz	230VAC/50Hz
12V Full Load	12.288V / 1A	12.322V/1A
12V 10% of FL	11.88V /0.1A	11.884V/0.1A
Note: cable compensation	3.4%	3.65%

Note: All output voltages are measured at output PCB board Edge. Internal Cable Compensation 8%

Key Performance Waveforms:

System start - up time

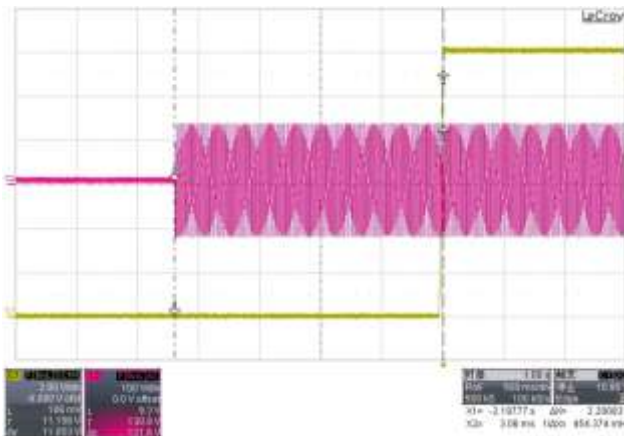

Figure 9: AP3981D2 turn on time 2.2s FL at 90Vac

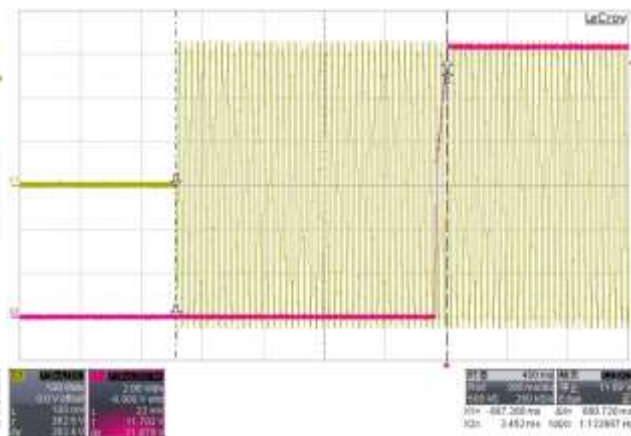

Figure 10: AP3981D2 turn on time 0.89s at FL, at 230Vac

System main switching Voltage Stress on AP3981D2 Pin 5,6,7,8

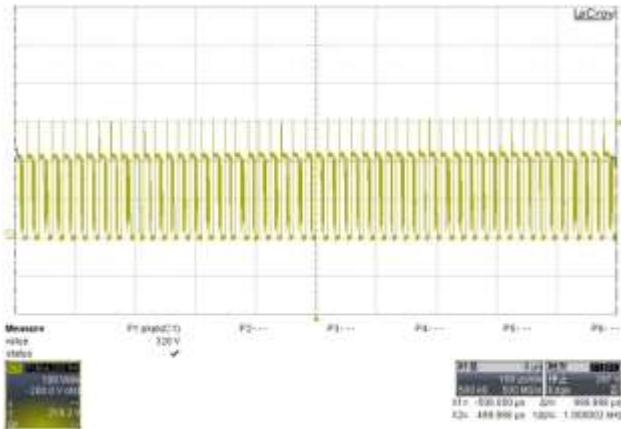

Figure 11: AP3981D Vds at FL at 90Vac Vds=320Vp-p
Vds=576Vp-p

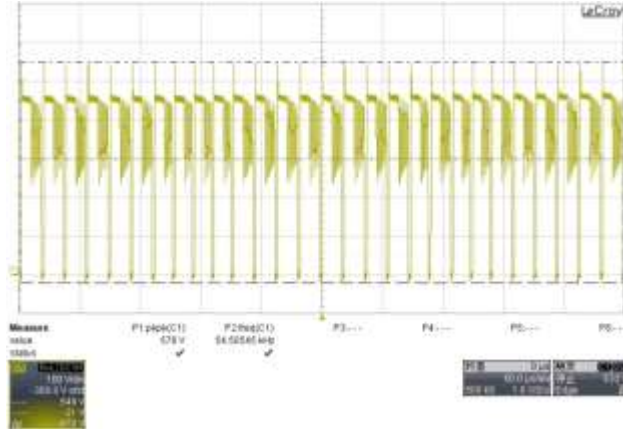

Figure 12: AP3981D Vds at FL at 264Vac,

System Voltage Stress across on U2 D-S

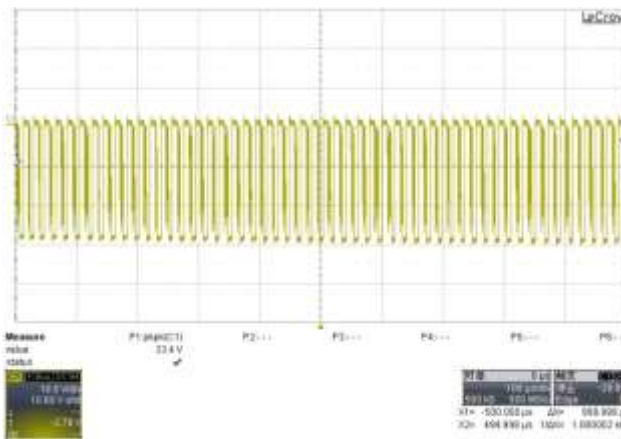

Figure 13: D3 D-S voltage stress at 90Vac FL
Vd3 d_S = 33.4Vp-p 10V/div

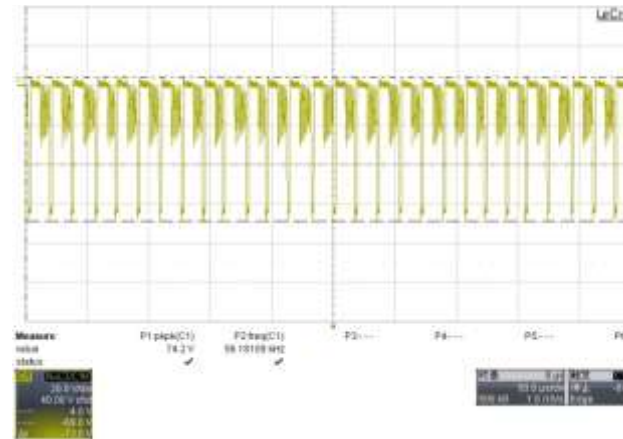

Figure 14: D3 D-S voltage stress at 264Vac at FL
Vd3 d_S = 74.2Vp-p 20V/div

System output Ripple performance

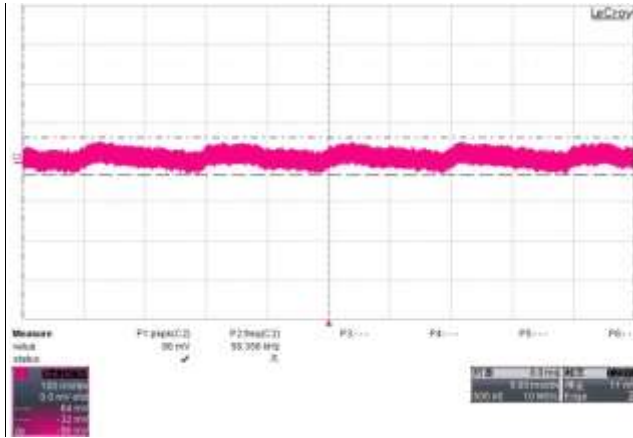

Figure 15: The Ripple at 90Vac_in Vpp=86mv FL

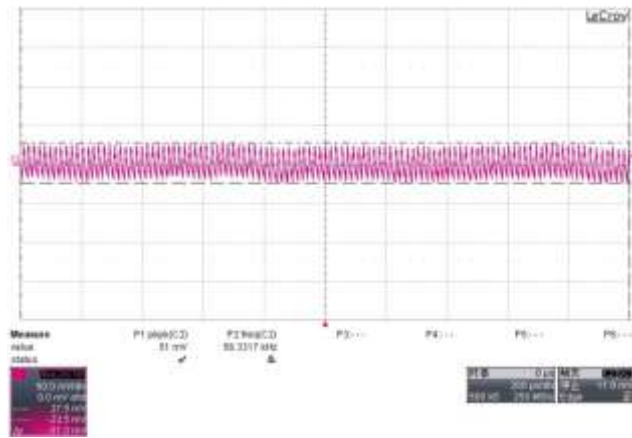

Figure 16: The Ripple at 264Vac_in Vpp=51mv FL

System Dynamic Response performance

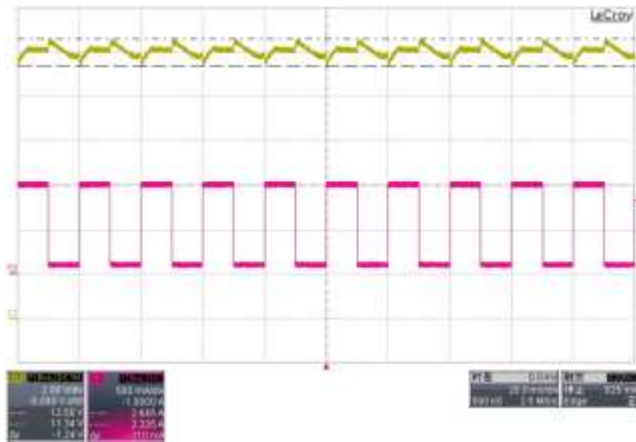

Figure 17: 90VAC; Load level: 0.1~1A; Vout: 12.58~11.34V

Frequency: 10ms~10mS. Slew rate: 0.25A/us

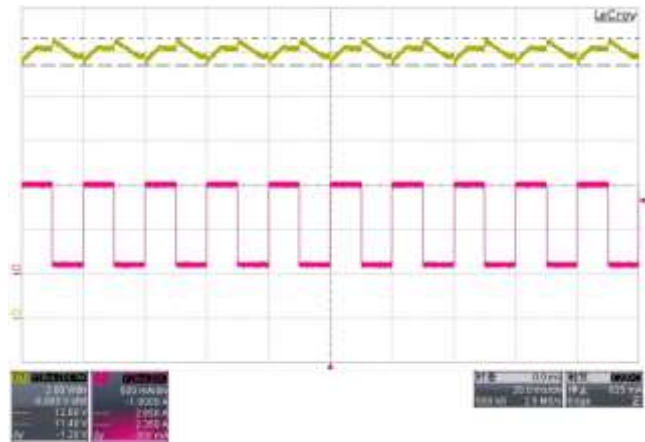

Figure 18: 264VAC; Load level: 0.1~1A; Vout: 12.60~11.4V

Frequency: 10ms~10mS. Slew rate: 0.25A/us

System Dynamic Response performance



Figure 19: 90VAC; Load level: 0.1~1A; Vout: 12.58~11.38V

Frequency: 100ms~100mS. Slew rate: 0.25A/us

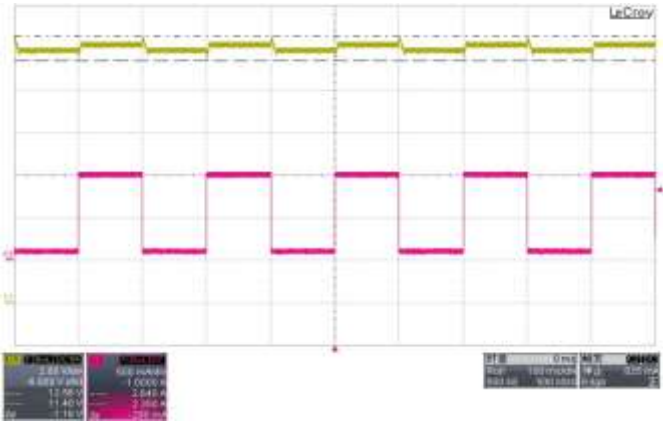

Figure 20: 264VAC; Load level: 0.1~1A; Vout: 12.56~11.4V

Frequency: 100ms~100mS. Slew rate: 0.25A/us

Thermal Test data at room Temperature after running 1 hr

@ 90Vac full load

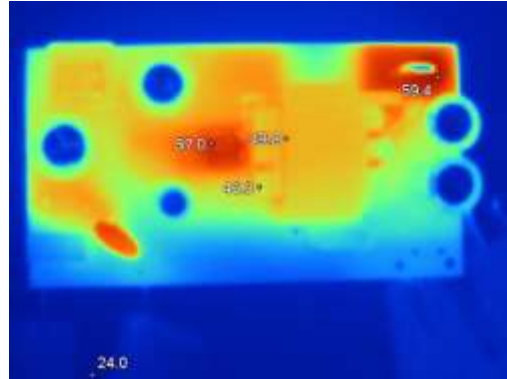
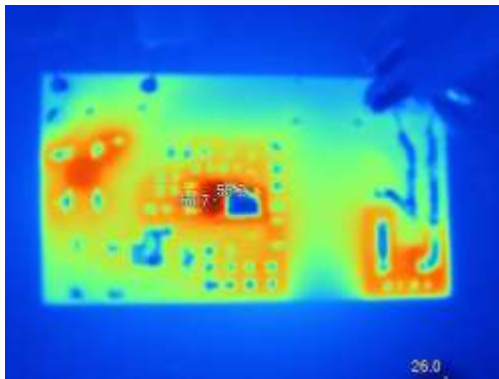

Figure21 Ta 26°C U1 AP3981D2 63.7°C D3 SR5100L 59.4°C T1 49.8°C

@ 264Vac full load

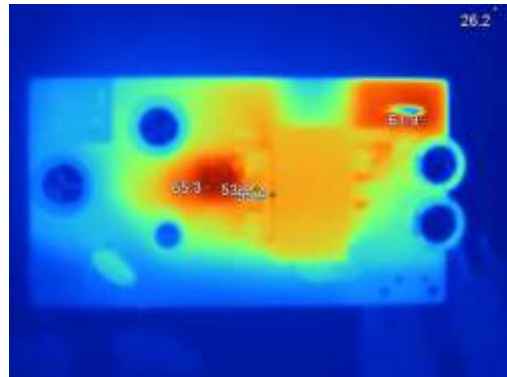
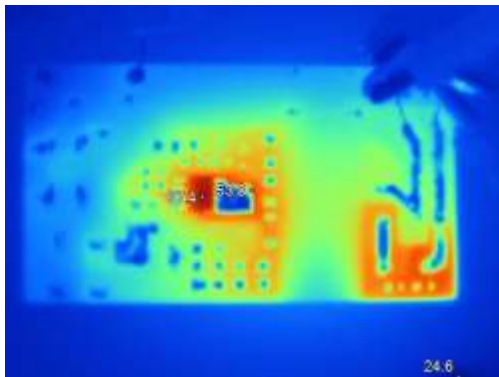

Figure22 Ta 25°C U1 AP3981D2 67.4°C D3 SR5100L 61.9°C T1 55.9°C

System EMI L-Line Scan Data

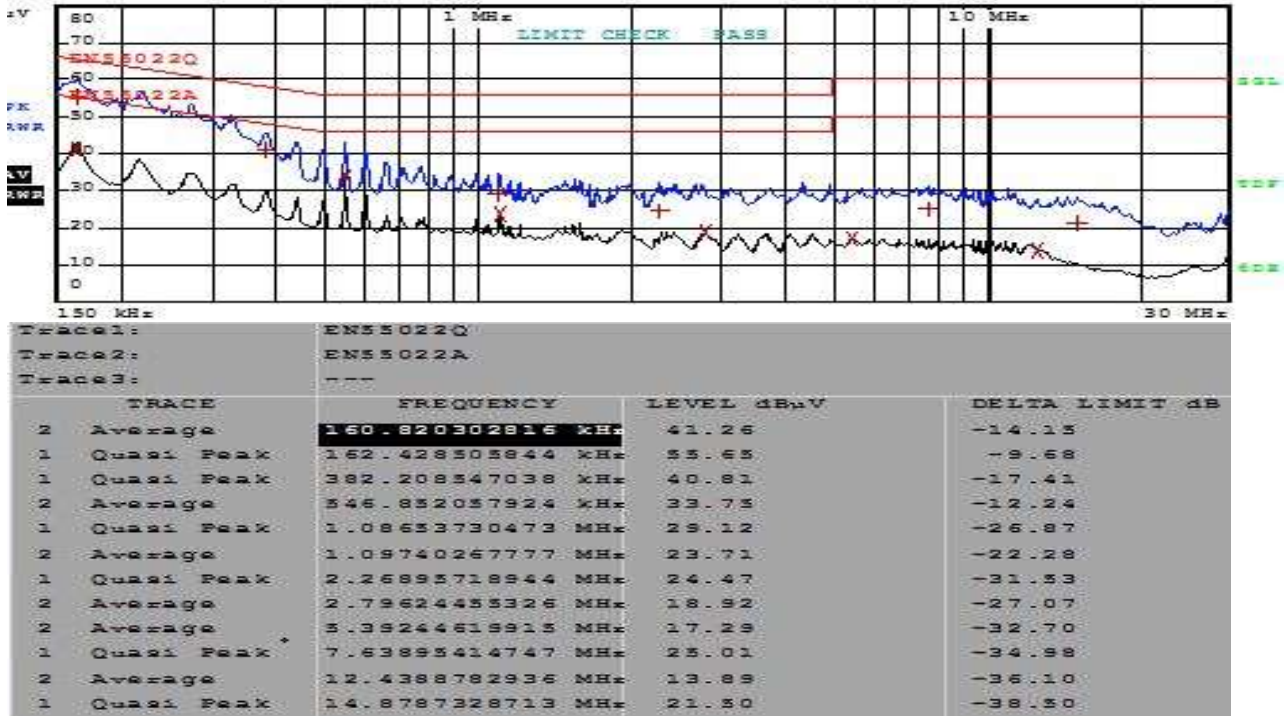

Figure 23: EMI Scan at 230Vac

System EMI N-Line Scan Data

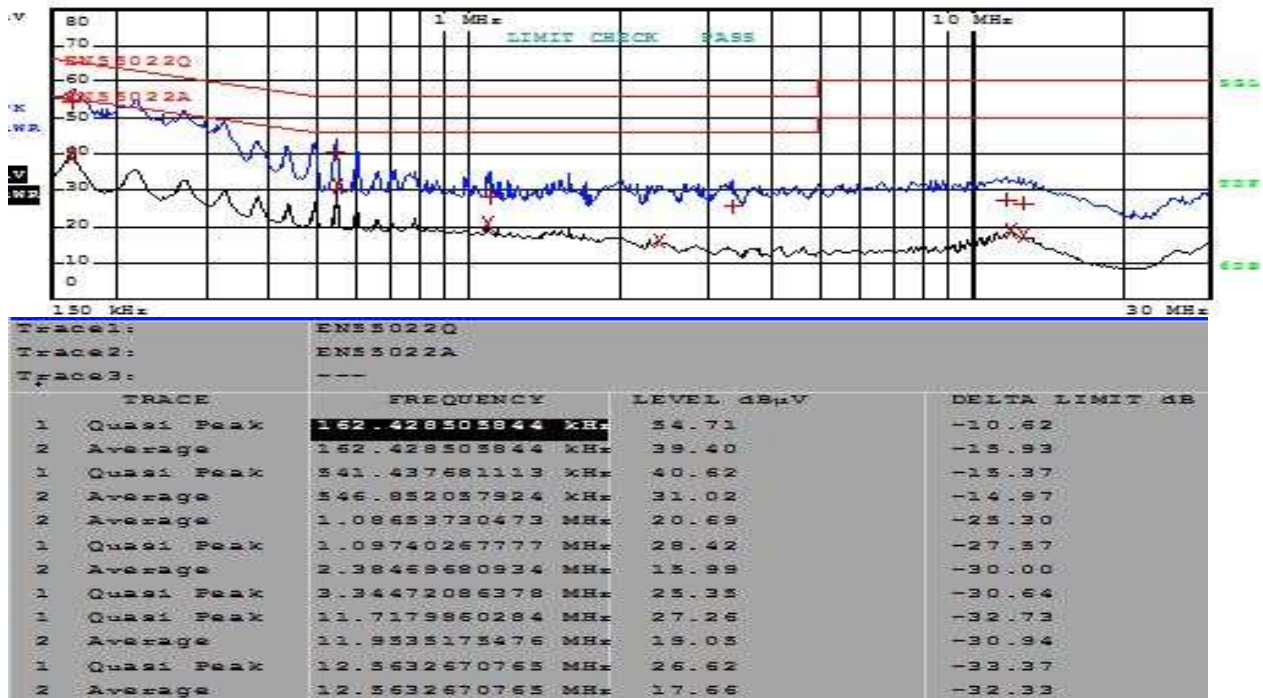

Figure 24: EMI Scan at 230Vac

Please see the recommend Application note for reference
(web page - http://www.diodes.com/appnote_dnote.html)

Check History

From	Change Reason	Changed Item	On Page
Rev1.0 to Rev 1.1	Add in detail part number	BD1, D1 & D2	4
	Put note: for D1& D2 Selecting Description	D1& D2 diode type selection, we propose D1standard and D2 fast diode (not SchottKy or super-fast recovery diode).	4
Rev 1.1 to Rev1.2	D1,D2,D3 add in Diodes part number for alternate parts & Add T1 Core & Bobbin size information	D1= S1MWF 1KV-1A D2= RS1MSWF 1KV-1A D3= SDT5H100SB 100V-5A SMB T1 use EE16 wider core & YTX-1622 wider Bobbin 5 x 5 pins	4

IMPORTANT NOTICE

DIODES INCORPORATED MAKES NO WARRANTY OF ANY KIND, EXPRESS OR IMPLIED, WITH REGARDS TO THIS DOCUMENT, INCLUDING, BUT NOT LIMITED TO, THE IMPLIED WARRANTIES OF MERCHANTABILITY AND FITNESS FOR A PARTICULAR PURPOSE (AND THEIR EQUIVALENTS UNDER THE LAWS OF ANY JURISDICTION).

Diodes Incorporated and its subsidiaries reserve the right to make modifications, enhancements, improvements, corrections or other changes without further notice to this document and any product described herein. Diodes Incorporated does not assume any liability arising out of the application or use of this document or any product described herein; neither does Diodes Incorporated convey any license under its patent or trademark rights, nor the rights of others. Any Customer or user of this document or products described herein in such applications shall assume all risks of such use and will agree to hold Diodes Incorporated and all the companies whose products are represented on Diodes Incorporated website, harmless against all damages.

Diodes Incorporated does not warrant or accept any liability whatsoever in respect of any products purchased through unauthorized sales channel.

Should Customers purchase or use Diodes Incorporated products for any unintended or unauthorized application, Customers shall indemnify and hold Diodes Incorporated and its representatives harmless against all claims, damages, expenses, and attorney fees arising out of, directly or indirectly, any claim of personal injury or death associated with such unintended or unauthorized application.

Products described herein may be covered by one or more United States, international or foreign patents pending. Product names and markings noted herein may also be covered by one or more United States, international or foreign trademarks.

This document is written in English but may be translated into multiple languages for reference. Only the English version of this document is the final and determinative format released by Diodes Incorporated.

LIFE SUPPORT

Diodes Incorporated products are specifically not authorized for use as critical components in life support devices or systems without the express written approval of the Chief Executive Officer of Diodes Incorporated. As used herein:

A. Life support devices or systems are devices or systems which:

1. are intended to implant into the body, or
2. support or sustain life and whose failure to perform when properly used in accordance with instructions for use provided in the labeling can be reasonably expected to result in significant injury to the user.

B. A critical component is any component in a life support device or system whose failure to perform can be reasonably expected to cause the failure of the life support device or to affect its safety or effectiveness.

Customers represent that they have all necessary expertise in the safety and regulatory ramifications of their life support devices or systems, and acknowledge and agree that they are solely responsible for all legal, regulatory and safety-related requirements concerning their products and any use of Diodes Incorporated products in such safety-critical, life support devices or systems, notwithstanding any devices- or systems-related information or support that may be provided by Diodes Incorporated. Further, Customers must fully indemnify Diodes Incorporated and its representatives against any damages arising out of the use of Diodes Incorporated products in such safety-critical, life support devices or systems.

Copyright © 2016, Diodes Incorporated

www.diodes.com