

General Description

This demonstration board utilizes the AL9901 high voltage PWM LED Buck controller with integrated MOSFET providing a cost effective solution for offline high brightness LED applications. This user-friendly evaluation board provides users with quick connection to their different types LEDs string. The demonstration board can be modified to adjust the LED output current (140mA) and the number of series connected LEDs that are driven.

Key Features

- Integrated 650V/2A MOSFET
- High output voltage, 50V
- ~ 86% efficiency
- <5% line regulation (100V_{AC} to 240V_{AC})
- Universal AC input voltage (100V_{AC} to 240V_{AC})
- No electrolytic capacitor
- Low BOM cost

Applications

- A60 Type LED light bulb
- Other LED lighting

AL9901 EV1 Specifications

Parameter	Value
Input Voltage	100 to 240V _{AC}
Output Power	6 – 8W
LED Current	140mA (Adjustable)
LED Voltage	51V
Efficiency	~86%
Number of LEDs	17 LEDs in series (Under Tested)
XYZ Dimension	0.6" x 2.4" x 0.6"
ROHS Compliance	Yes

Evaluation Board



Figure 1: Top View



Figure 2: Bottom View

Connection Instructions

Input Voltage: 100 to 240V_{AC} (AC+, AC-)
 LED Outputs: LED+ (Red), LED- (Black)

Evaluation Board Schematic

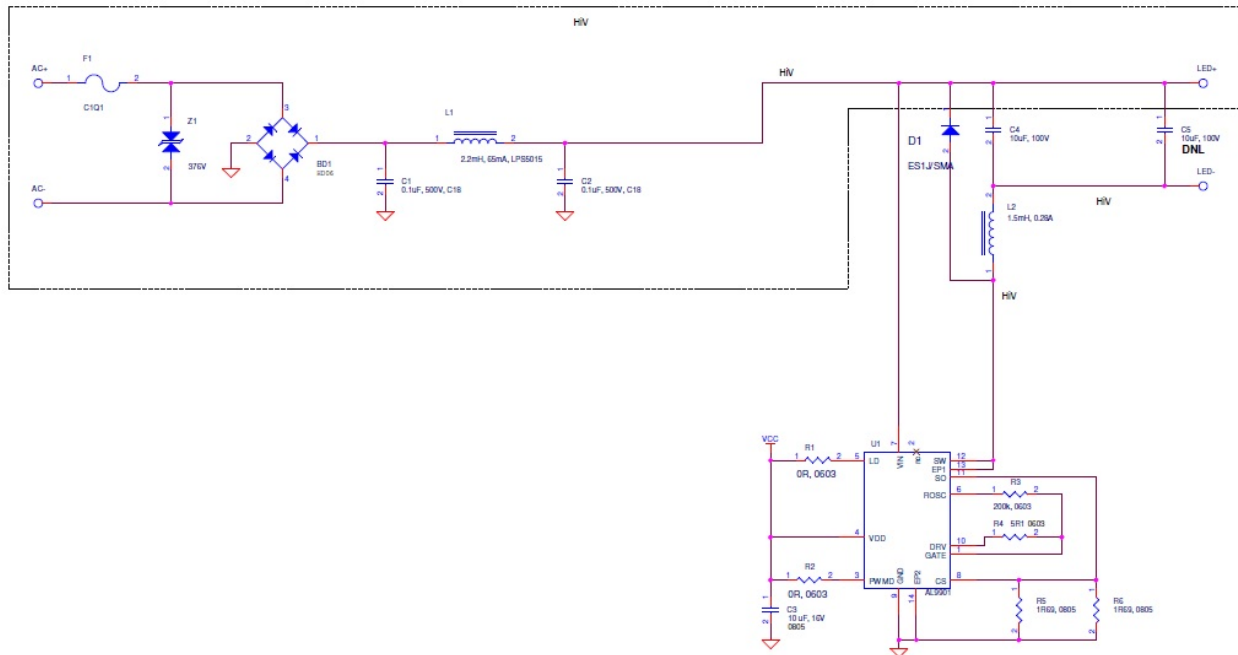

Figure 3: Evaluation Board Schematic

Evaluation Board Layout

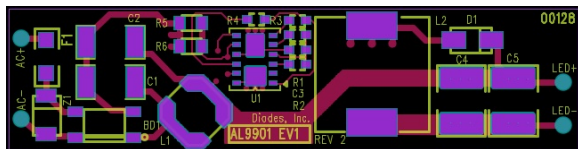

Figure 4: PCB Board Layout Top View

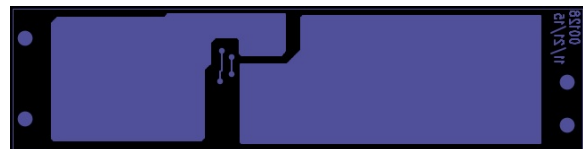

Figure 5: PCB Board Layout Bottom View

Quick Start Guide

1. By default, the evaluation board is preset at 140mA LED Current by R5 and R6. Non-Dimmable by R2, remove R2 to allow PWM Dimming input.
2. Ensure that the AC source is switched OFF or disconnected.
3. Connect the AC line wires of power supply to "AC+ and AC-" on the left side of the board.
4. Connect the anode wire of external LED string to LED+ output test point.
5. Connect the cathode wire of external LED string to LED- output test point.
6. Turn on the main switch. LED string should light up.

Bill of Material

#	Name	QTY	Part number	Manufacturer	Description
1	U1	1	AL9901DFN6040-12	Diodes Inc	LED Driver
2	BD1	1	HD06-T	Diodes Inc	Bridge Rectifiers 0.8A 600V
3	D1	1	ES1G-13-F	Diodes Inc	DIODE Super FAST 1A 400V SMA
4	Z1	1	SMBJP6KE440CA	Diodes Inc	TVS bidirectional diode 600W 602V
5	L1	1	LPS5015-225ML	Coilcraft	2.2mH 64mA
6	L2	1	13R155C	Murata	IND Power 1.5mH
7	C1, C2	2	VJ1812Y104KXEAT5Z	Vishay	CAP CER (MLCC) - SMD/SMT 1812 0.1uF 500V X7R 10%
8	C3	1	C1608X7R1A105K	TDK	CAP CER 1.0uF 10V X7R 0603
9	C5	1	GRM32ER71J106MA12L	Murata	Multilayer Ceramic Capacitors (1210) 10uF 63V X7R 10%
10	R1,R2	2	RC0603JR-070RL	Yageo	JMPR 0.0Ω 1/4W 0603 SMD
11	R3	1	RC0603FR-07200KL	Yageo	RES 200KΩ 1/10W 1% 0603 SMD
12	R4	1	RC0603FR-0722RL	Yageo	RES 22Ω 1/10W 1% 0603 SMD
13	R5, R6	2	RL0805FR-071R69L	Yageo	RES 1.69Ω 1/8W 1% 0805 SMD
14	F1	1	2410SFV1.00FM/125-2	Bel Fuse	Fuse, 1A, 250V, 1810

Functional Performance (No Electrolytic Capacitor across output LEDs)

Board Type	VIN (VAC)	PFC	IIN (mA)	PIN (W)	VLED (V)	ILED (mA)	PLED (W)	ILED Ripple (%)	Efficiency (%)	Athd (%)
AL9901EV1 Module Board	100	0.750	98.63	7.40	48.42	126.7	6.13	100	82.85	61.38
	110	0.730	94.43	7.55	48.52	130.2	6.32	100	83.65	63.22
	120	0.710	90.33	7.71	48.62	133.5	6.49	100	84.22	66.74
	130	0.693	87.12	7.85	48.68	136.3	6.63	100	84.56	71.20
	200	0.615	71.24	8.75	49.05	149.8	7.35	100	83.93	91.73
	210	0.604	70.37	8.90	49.08	151.8	7.45	100	83.73	92.30
	220	0.602	68.28	9.02	49.11	153.3	7.53	100	83.49	99.95
	230	0.592	67.14	9.15	49.12	155.0	7.61	100	83.16	94.22
	240	0.583	66.14	9.30	49.14	156.5	7.69	100	82.73	94.55

Functional Performance (optional 68 μ F Electrolytic Capacitor across output LEDs to reduce ripple)

Board Type	VIN (VAC)	PFC	IIN (mA)	PIN (W)	VLED (V)	ILED (mA)	PLED (W)	ILED Ripple (%)	Efficiency (%)	Athd (%)
AL9901EV1 Module Board	100	0.759	100.41	7.63	48.82	131.4	6.41	50	84.09	59.02
	110	0.740	95.21	7.74	48.85	135.1	6.60	50	85.26	59.71
	120	0.723	90.93	7.88	48.88	138.5	6.77	50	85.95	65.55
	130	0.706	87.30	8.01	48.91	141.5	6.92	50	86.42	68.75
	200	0.629	71.07	8.85	49.09	156.3	7.67	50	86.68	93.69
	210	0.616	69.56	8.99	49.11	158.3	7.77	50	86.43	98.13
	220	0.609	68.26	9.13	49.10	160.2	7.86	50	86.18	95.41
	230	0.607	66.36	9.24	49.11	161.7	7.94	50	85.93	94.56
	240	0.601	65.63	9.38	49.12	163.4	8.03	50	85.55	98.23

Functional Performance

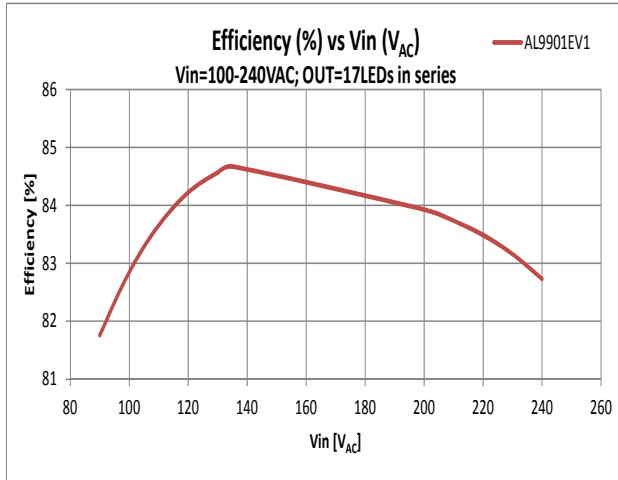

Figure 1. Efficiency vs. Vin

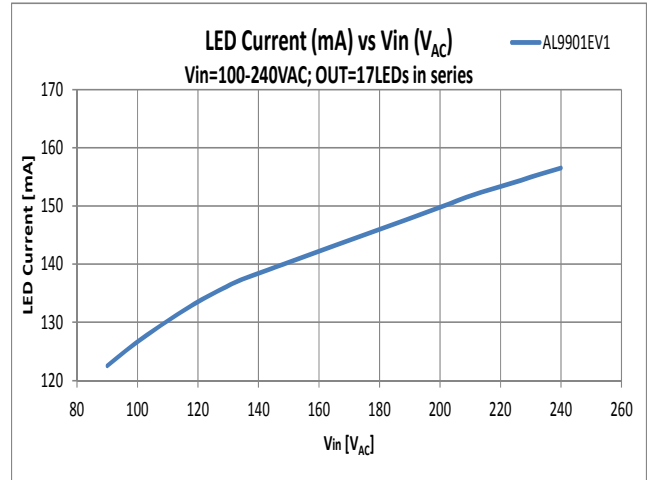

Figure 2. LED Current vs. Vin

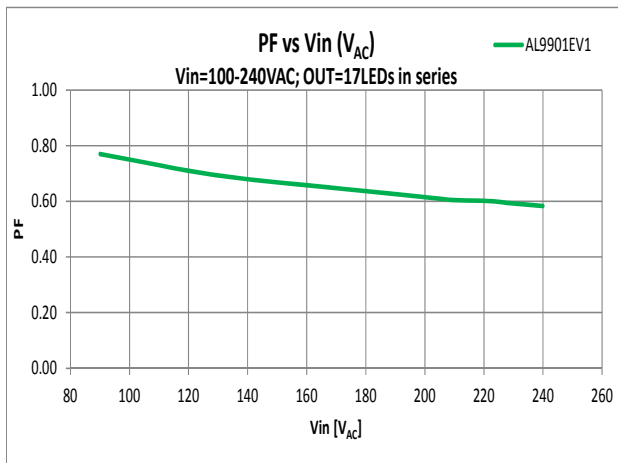
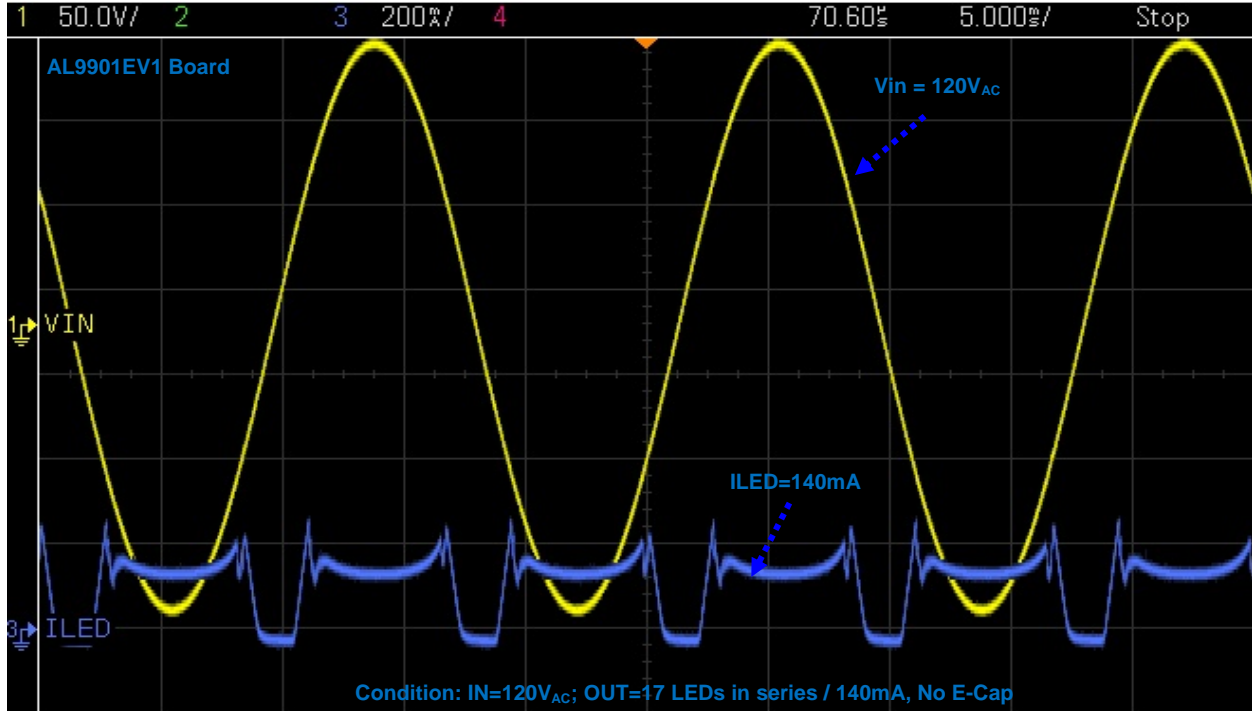
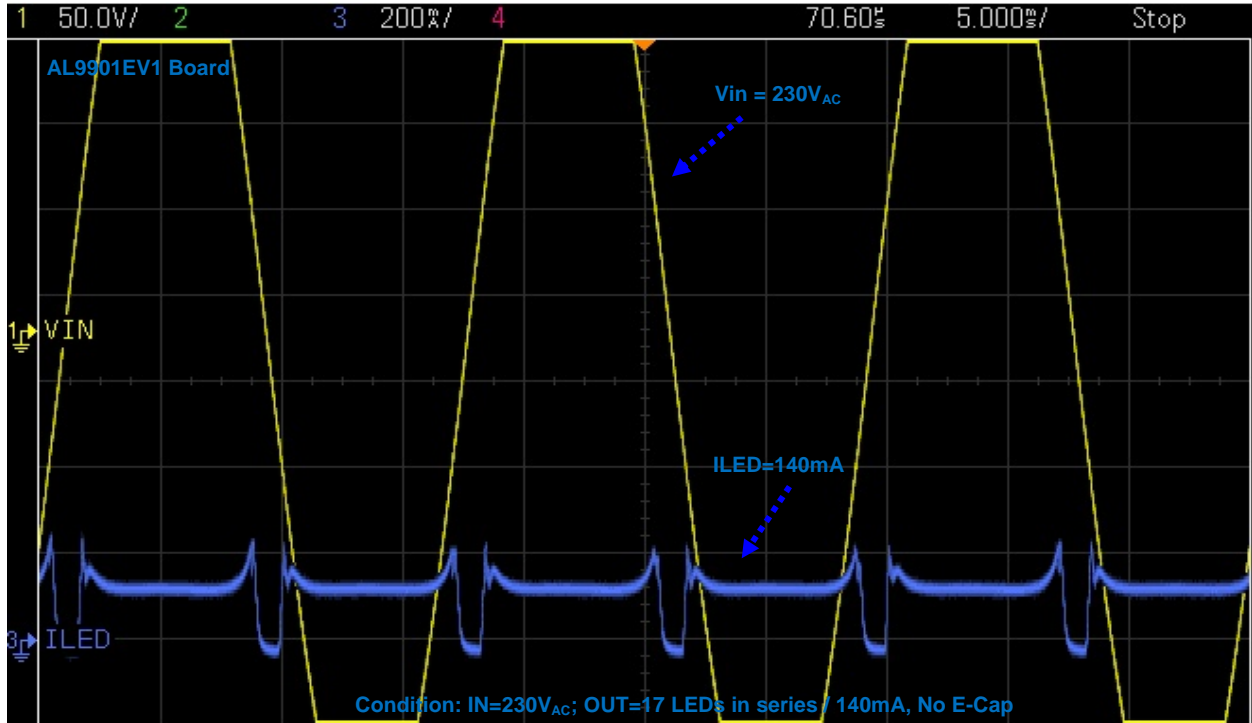

Figure 3. PFC vs. Vin

Waveform #1=> Channel 1: Vin = 120V_{AC}, Channel 3: ILED



Waveform #2=> Channel 1: Vin = 230V_{AC}, Channel 3: ILED



Waveform #3=> Channel 1: Vin = 120V_{AC}, Channel 3: ILED with 68uF Electrolytic Capacitor

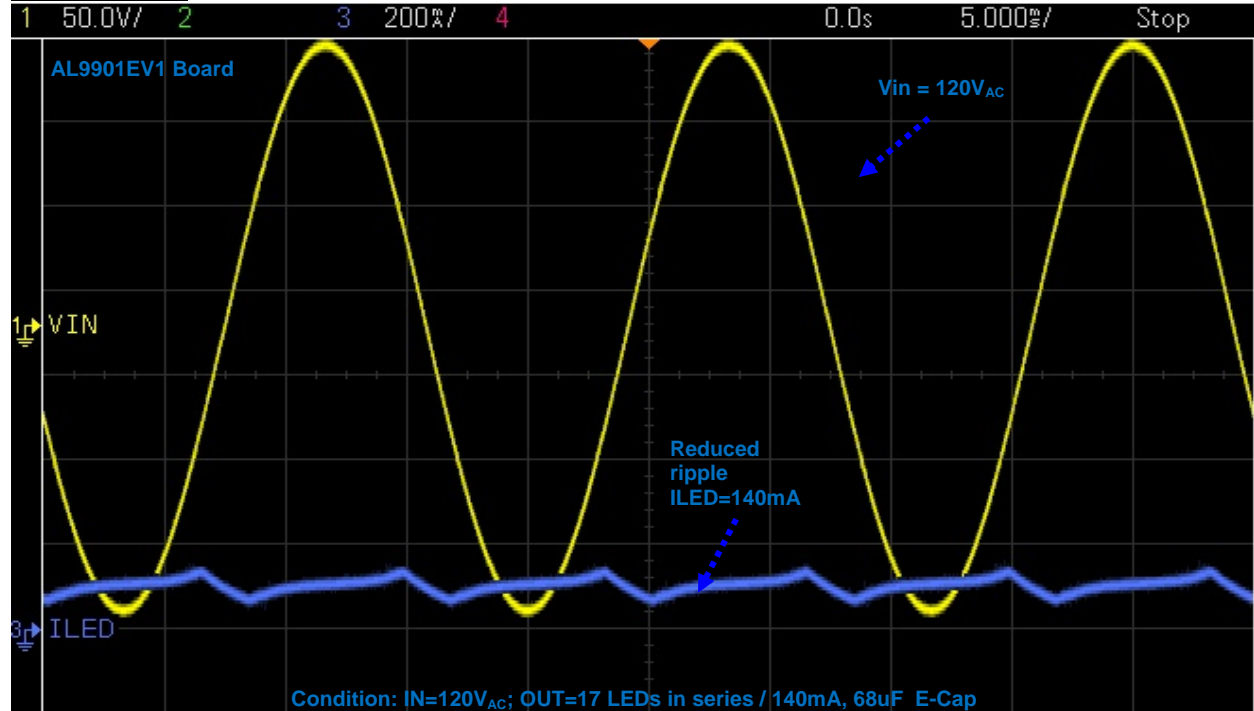

Waveform #4=> Channel 1: Vin = 230V_{AC}, Channel 3: ILED with 68uF Electrolytic Capacitor

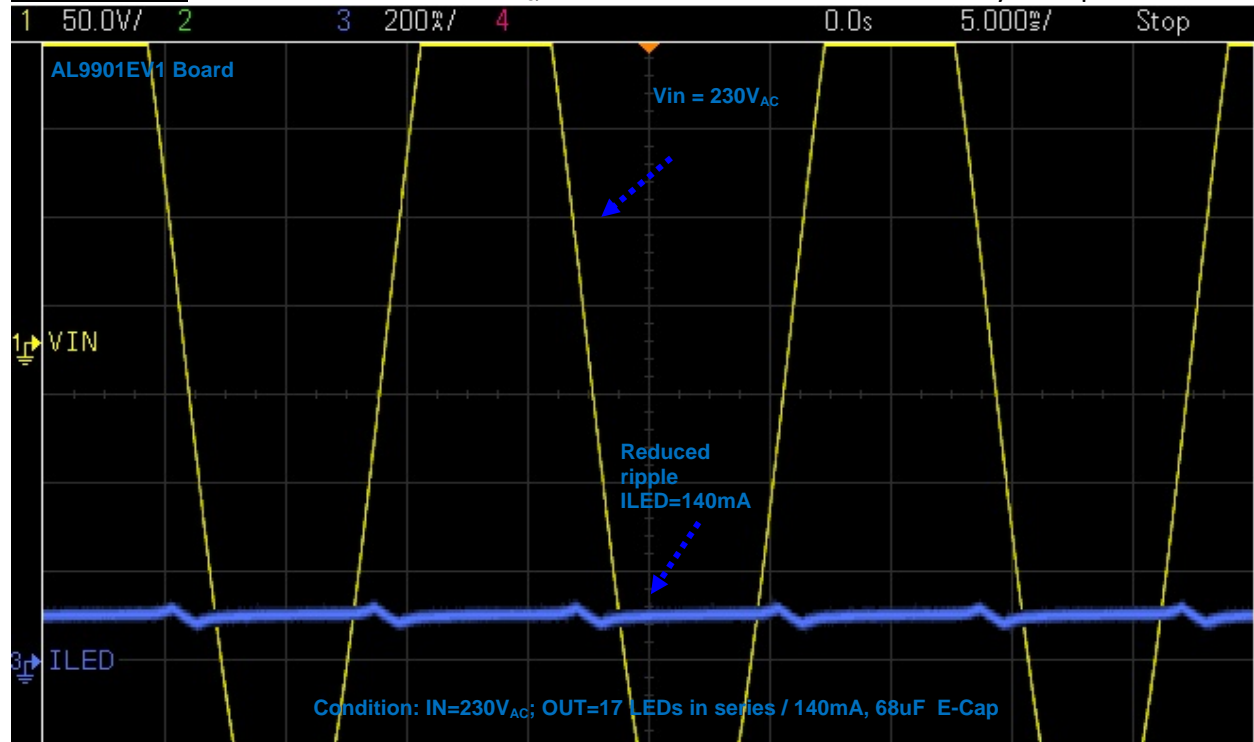

IMPORTANT NOTICE

DIODES INCORPORATED MAKES NO WARRANTY OF ANY KIND, EXPRESS OR IMPLIED, WITH REGARDS TO THIS DOCUMENT, INCLUDING, BUT NOT LIMITED TO, THE IMPLIED WARRANTIES OF MERCHANTABILITY AND FITNESS FOR A PARTICULAR PURPOSE (AND THEIR EQUIVALENTS UNDER THE LAWS OF ANY JURISDICTION).

Diodes Incorporated and its subsidiaries reserve the right to make modifications, enhancements, improvements, corrections or other changes without further notice to this document and any product described herein. Diodes Incorporated does not assume any liability arising out of the application or use of this document or any product described herein; neither does Diodes Incorporated convey any license under its patent or trademark rights, nor the rights of others. Any Customer or user of this document or products described herein in such applications shall assume all risks of such use and will agree to hold Diodes Incorporated and all the companies whose products are represented on Diodes Incorporated website, harmless against all damages.

Diodes Incorporated does not warrant or accept any liability whatsoever in respect of any products purchased through unauthorized sales channel.

Should Customers purchase or use Diodes Incorporated products for any unintended or unauthorized application, Customers shall indemnify and hold Diodes Incorporated and its representatives harmless against all claims, damages, expenses, and attorney fees arising out of, directly or indirectly, any claim of personal injury or death associated with such unintended or unauthorized application.

Products described herein may be covered by one or more United States, international or foreign patents pending. Product names and markings noted herein may also be covered by one or more United States, international or foreign trademarks.

This document is written in English but may be translated into multiple languages for reference. Only the English version of this document is the final and determinative format released by Diodes Incorporated.

LIFE SUPPORT

Diodes Incorporated products are specifically not authorized for use as critical components in life support devices or systems without the express written approval of the Chief Executive Officer of Diodes Incorporated. As used herein:

A. Life support devices or systems are devices or systems which:

1. are intended to implant into the body, or
2. support or sustain life and whose failure to perform when properly used in accordance with instructions for use provided in the labeling can be reasonably expected to result in significant injury to the user.

B. A critical component is any component in a life support device or system whose failure to perform can be reasonably expected to cause the failure of the life support device or to affect its safety or effectiveness.

Customers represent that they have all necessary expertise in the safety and regulatory ramifications of their life support devices or systems, and acknowledge and agree that they are solely responsible for all legal, regulatory and safety-related requirements concerning their products and any use of Diodes Incorporated products in such safety-critical, life support devices or systems, notwithstanding any devices- or systems-related information or support that may be provided by Diodes Incorporated. Further, Customers must fully indemnify Diodes Incorporated and its representatives against any damages arising out of the use of Diodes Incorporated products in such safety-critical, life support devices or systems.

Copyright © 2015, Diodes Incorporated

www.diodes.com