

General Description

The AL5892 is an offline dimmable linear LED driver with high integration of constant current control and smart bleeder operation. With the built-in 350V main power MOSFET and 500V bleeder MOSFET, the AL5892 offers users to design a triac dimmable LED driver with extremely few external components and minimized system BOM cost. Because of the linear operation of the IC, the AL5892 LED driver is compliant with EMI standards without adding any EMI components. The AL5892 is optimized to work at 120V_{AC} input mains voltage.

With an innovative efficiency compensation method, the AL5892 operates up to 85% efficiency with driving a single high-voltage LED chain.

The AL5892 detects a triac dimmer signal and controls the smart bleeder to turn on and off, thus it offers the LED driver good dimmer compatibility with both leading edge and trailing edge dimmers. The AL5892 also converts the dimmer signal to optimize the dimming curve to be compliant with NEMA SSL7.

The AL5892 has abundant of protection features, such as LED short protection (OSP), thermal foldback protection (TFP) and over temperature shutdown protection (OTP).

The AL5892 is available in SO-8EP package

to enhance the thermal reliability of the LED driver.

Applications

- LED Lamps
- Retro Fit TRIAC Dimming
- LED power modules

Key Features

- Integrated 350V Main MOSFET and 500V Bleeder MOSFET
- Low operation current ~300uA
- Tight current sense tolerance $\pm 3\%$
- Output Current Programmable up to 75mA
- Wide range of dimmer compatibility
- Dimming Curve compliant to NEMA SSL7
- Internal Protections
- LED Open/Short Protection(OSP)
- Thermal Foldback Protection(TFP)
- Over Temperature Shutdown Protection (OTP)
- Power Factor >0.7
- Efficiency up to 85%
- SO-8EP package

AL5892EV4 Specifications

Parameter	Value
Input Voltage	108V _{AC} ~132V _{AC}
LED Current	58.8mA
LED Voltage	130V~140V
Dimension	Φ51mm x 1.6mm

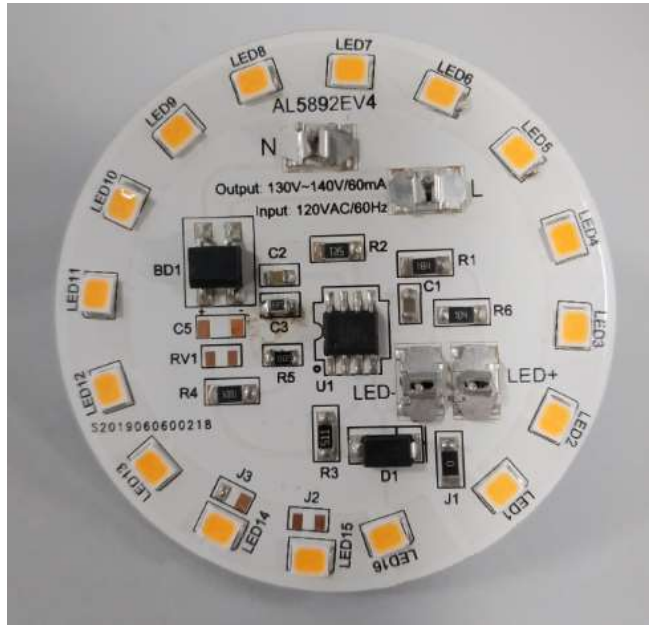

Figure 1: Top View

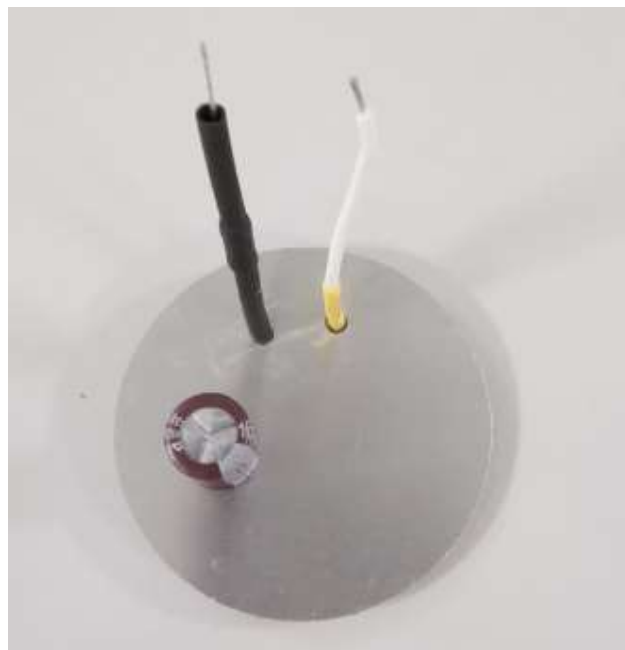

Figure 2: Bottom View

Connection Instructions

Power Supply Input: 120V_{AC} (white: Neutral, black: Line)

Evaluation Board Schematic

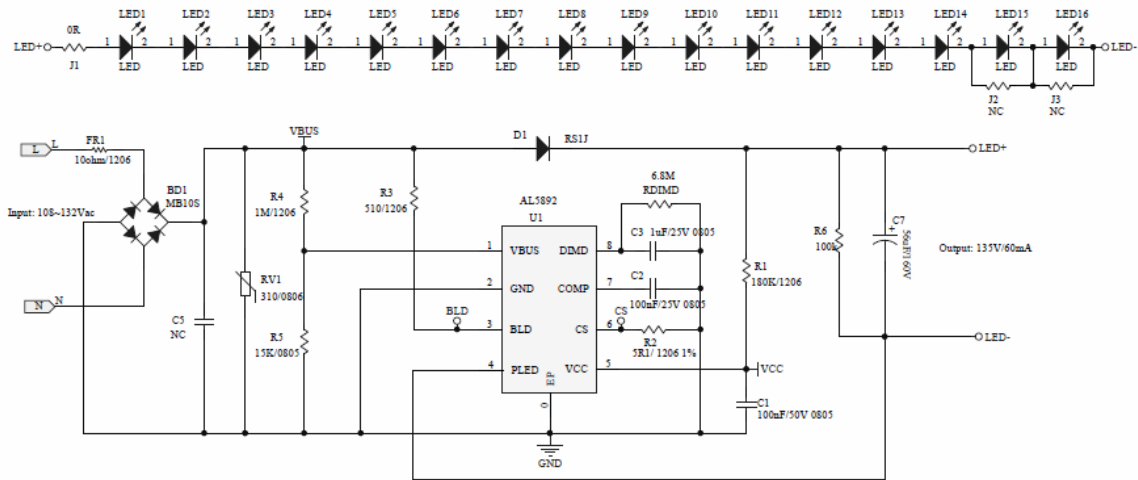

Figure 3: Evaluation Board Schematic

Evaluation Board Layout

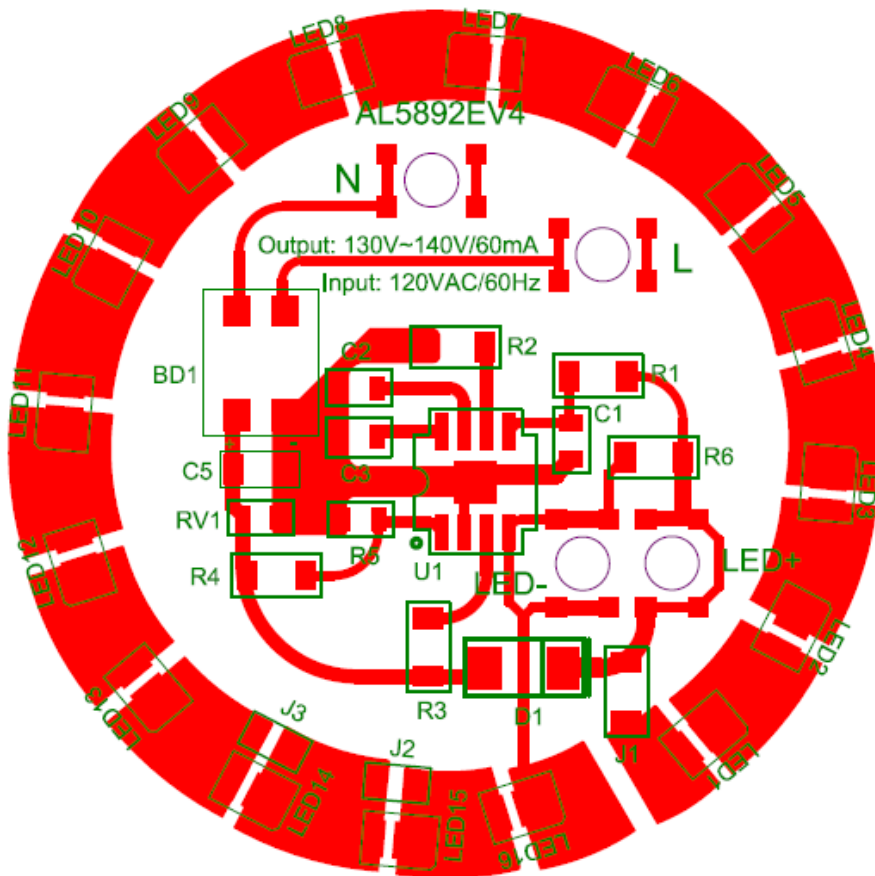

Figure 4: PCB Board Layout Top View

Quick Start Guide

1. By default, the LED current of evaluation board is preset at 59mA.
2. Ensure that the AC source is switched OFF or disconnected before soldering or connecting.
3. Remove the J1 (0ohm), insert an ammeter to measure LED current or monitor LED current waveform.
4. Ensure that the area around the board is clear and safe, and preferably that the board and LEDs are enclosed in a transparent safety cover.
5. Connect AC source Line to Black wire, connect Neutral to white wire.
6. Turn on the main switch. LED string should light up.

Bill of Material

No.	Item	Description	Package	QTY
1	C1,C2	Ceramic Cap, 100nF/50V,X7R	0805	2
2	C3	Ceramic Cap, 1uF/25V,X7R	0805	1
3	C7	E-Cap, 105°C,56uF/160V, 10*16mm	DIP	1
4	BD1	Rectifier Bridge,MB10S,0.5A/1000V	SOPA-4	1
5	D1	Fast Recovery Diode, RS1J, 1A/1KV	SMA	1
6	FR1	Fuse Resistor,10R, 5%, 1W	SMD	1
7	RV1	SMD Varistor, 310V	SMD	1
8	R1	Resistor,180K, 5%, 1/4W	1206	1
9	R2	Resistor,5R1, 1%, 1/4W	0805	1
10	R3	Resistor, 510R, 5%, 1/4W	1206	1
11	R4	Resistor,1M, 1%, 1/4W	1206	1
12	R5	Resistor,15K, 1%, 1/8W	0805	1
13	R6	Resistor,100K, 5%, 1/4W	1206	1
14	U1	AL5892 Diodes Linear Dimmable IC	PSOP8	1
15	J1	Resistor,0R, 5%, 1/4W	1206	1
16	RDIMD	Resistor,6.8M, 5%, 1/8W	0805	1
17	LED1~16	LED, VF=8.4V~10.4V IF=100mA	2835	16

System Performance

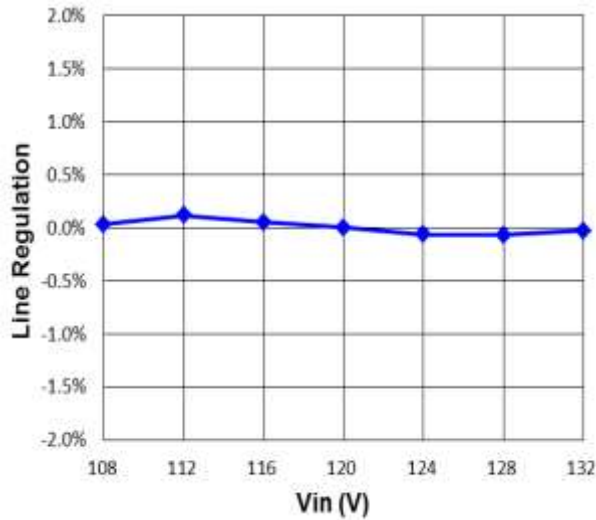

Figure 6: LED current vs input voltage

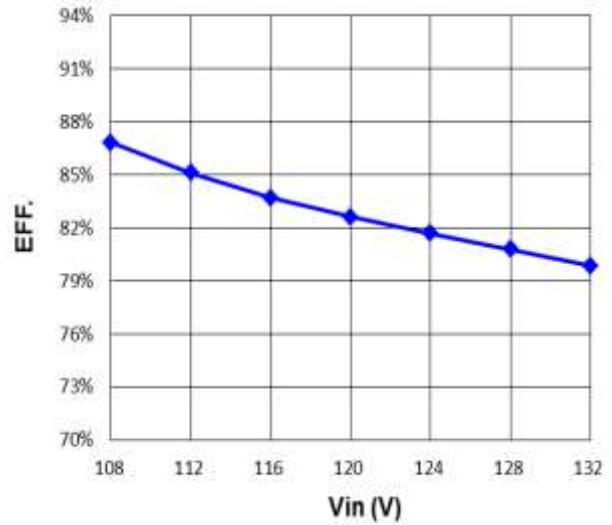

Figure 7: Efficiency vs input voltage

LED current setup

The LED current is set by the reference voltage and the current sensing resistor. The reference voltage is 0.3V.

Then the output current for LED strings can be calculated by:

$$I_{OUT} = 0.3V / R_{SENSE}$$

On the board, the R_{SENSE} is 5.10Ω, so the output current is 58.8mA.

Waveforms:

Test condition: input 120V_{AC}, output 135V/58.8Ma

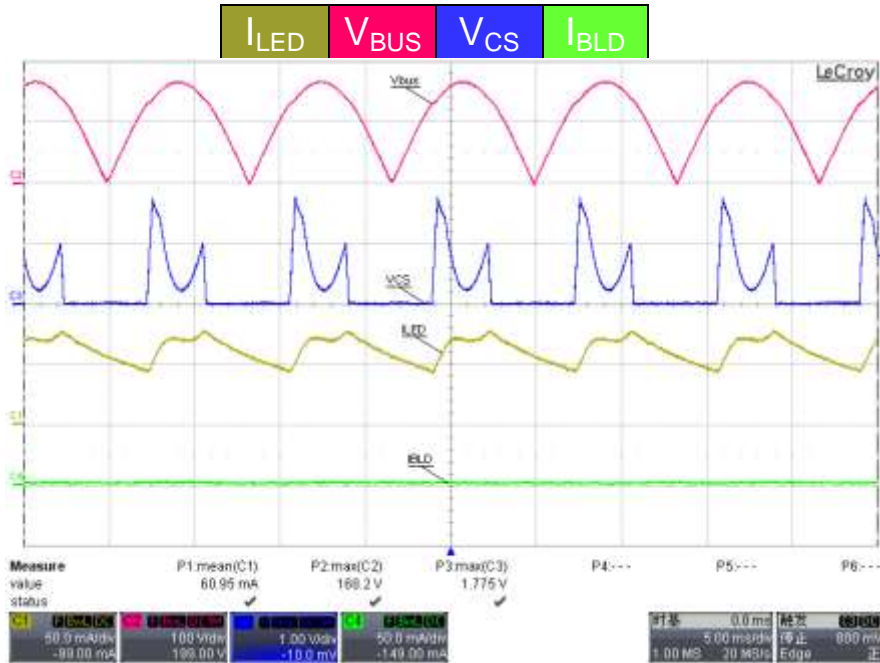

Figure 11: Without dimmer operating

With Leading & Trailing dimmer:

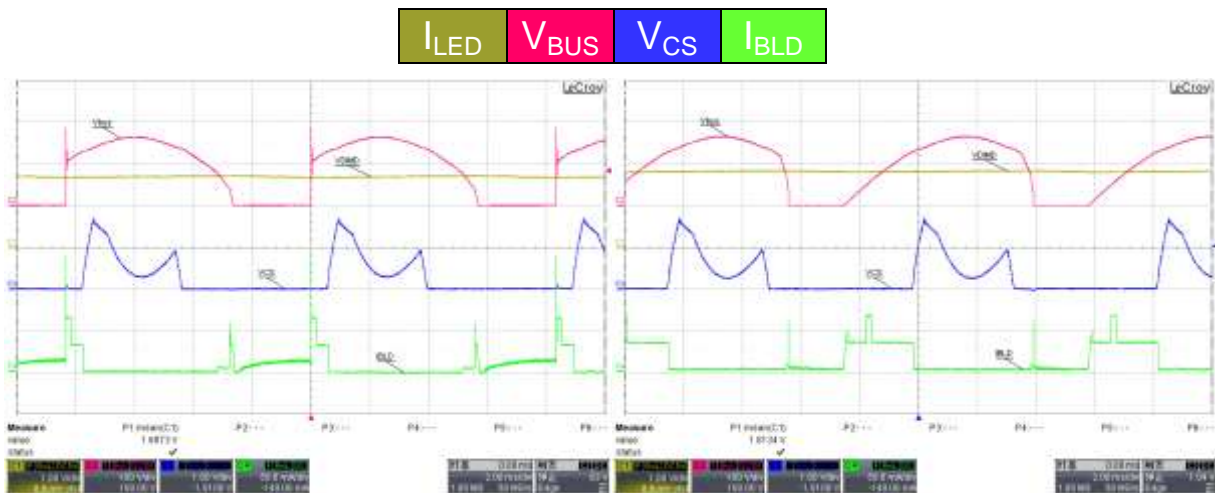

Figure 12: Operating with leading dimmer

Figure 13: Operating with trailing dimmer

Start up:

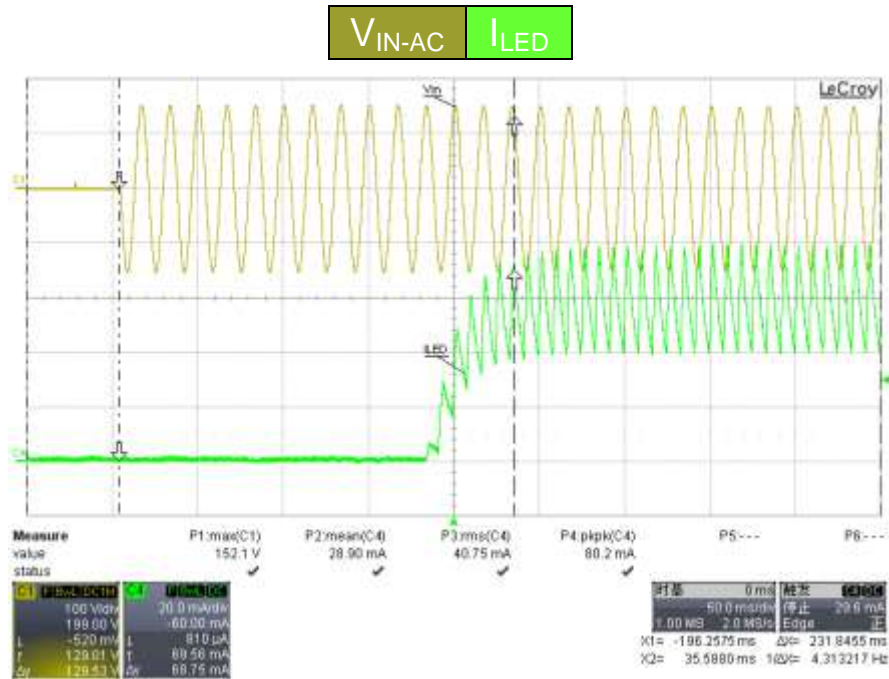

Figure 13: Turn ON

LED short Protection:

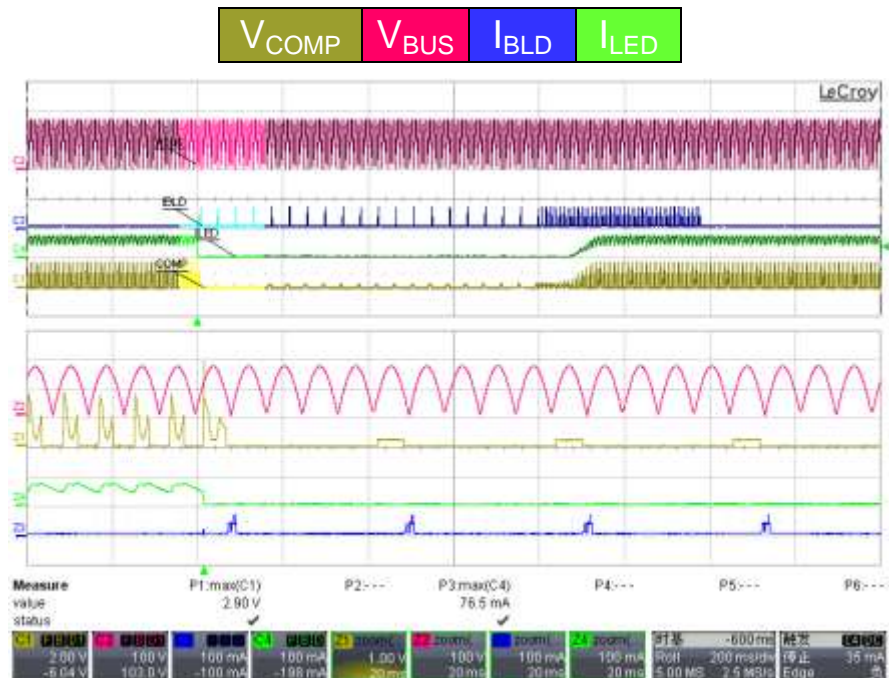
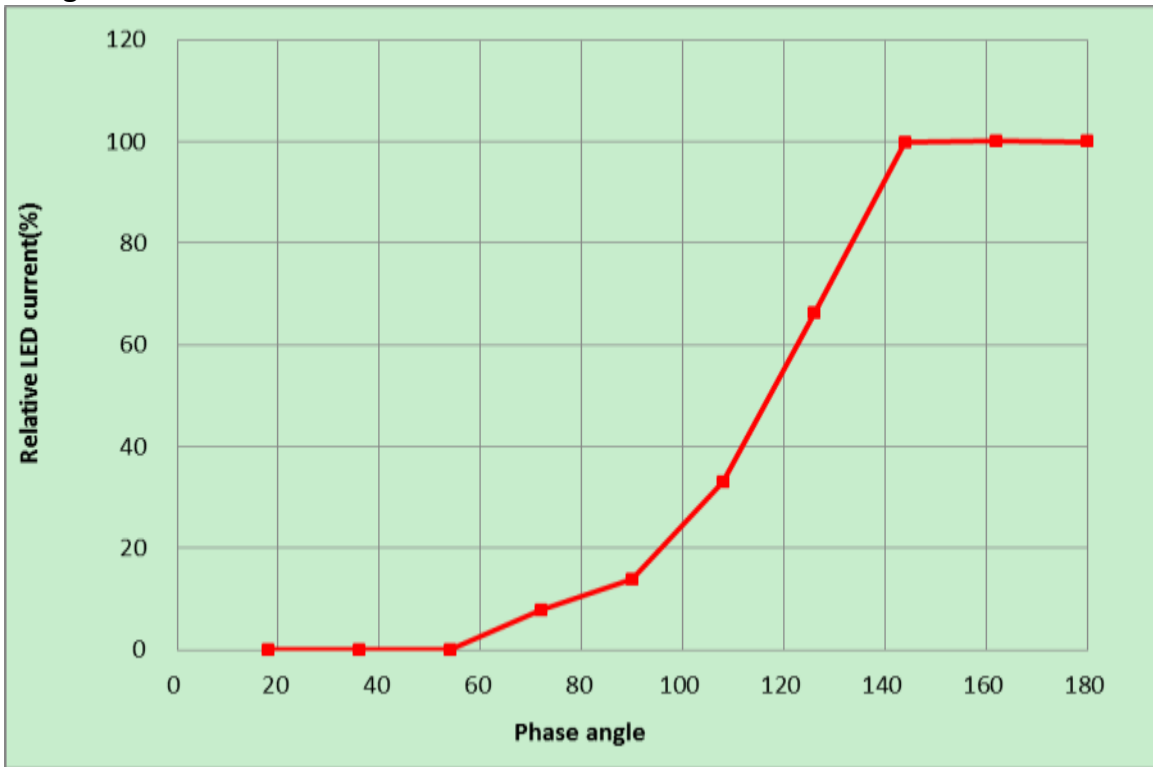

Figure 14: LED Short Protection

Dimming Curve:



IMPORTANT NOTICE

DIODES INCORPORATED MAKES NO WARRANTY OF ANY KIND, EXPRESS OR IMPLIED, WITH REGARDS TO THIS DOCUMENT, INCLUDING, BUT NOT LIMITED TO, THE IMPLIED WARRANTIES OF MERCHANTABILITY AND FITNESS FOR A PARTICULAR PURPOSE (AND THEIR EQUIVALENTS UNDER THE LAWS OF ANY JURISDICTION).

Diodes Incorporated and its subsidiaries reserve the right to make modifications, enhancements, improvements, corrections or other changes without further notice to this document and any product described herein. Diodes Incorporated does not assume any liability arising out of the application or use of this document or any product described herein; neither does Diodes Incorporated convey any license under its patent or trademark rights, nor the rights of others. Any Customer or user of this document or products described herein in such applications shall assume all risks of such use and will agree to hold Diodes Incorporated and all the companies whose products are represented on Diodes Incorporated website, harmless against all damages.

Diodes Incorporated does not warrant or accept any liability whatsoever in respect of any products purchased through unauthorized sales channel.

Should Customers purchase or use Diodes Incorporated products for any unintended or unauthorized application, Customers shall indemnify and hold Diodes Incorporated and its representatives harmless against all claims, damages, expenses, and attorney fees arising out of, directly or indirectly, any claim of personal injury or death associated with such unintended or unauthorized application.

Products described herein may be covered by one or more United States, international or foreign patents pending. Product names and markings noted herein may also be covered by one or more United States, international or foreign trademarks.

LIFE SUPPORT

Diodes Incorporated products are specifically not authorized for use as critical components in life support devices or systems without the express written approval of the Chief Executive Officer of Diodes Incorporated. As used herein:

A. Life support devices or systems are devices or systems which:

1. are intended to implant into the body, or
2. support or sustain life and whose failure to perform when properly used in accordance with instructions for use provided in the labeling can be reasonably expected to result in significant injury to the user.

B. A critical component is any component in a life support device or system whose failure to perform can be reasonably expected to cause the failure of the life support device or to affect its safety or effectiveness.

Customers represent that they have all necessary expertise in the safety and regulatory ramifications of their life support devices or systems, and acknowledge and agree that they are solely responsible for all legal, regulatory and safety-related requirements concerning their products and any use of Diodes Incorporated products in such safety-critical, life support devices or systems, notwithstanding any devices- or systems-related information or support that may be provided by Diodes Incorporated. Further, Customers must fully indemnify Diodes Incorporated and its representatives against any damages arising out of the use of Diodes Incorporated products in such safety-critical, life support devices or systems.

Copyright © 2020, Diodes Incorporated

www.diodes.com