

### General Description

The AL5810 Linear LED driver offers excellent temperature and voltage current stability with output adjustable handling capability. The AL5810 simplifies the design of LED drivers by setting the LED current with an external resistor using standard value resistors.

The AL5810 has an open drain output that can swing from 2.0V up to 60V supply voltage enabling it drive long LED chains for high-side or low-side LED strings. Its low 0.5V RSET pin is outside of the LED current path and can maintain current accuracy while minimizing the required overheads to regulate the LED current. This reduces its power dissipation compared to traditional linear LED drivers, making it ideal for driving LEDs up to 250mA.

The AL5810 is available in the Wettable Flank W-DFN2020-3 (2mm x 2mm), power dissipation (PDIS) up to 2W and TO-252 (DPAK) package, (PDIS) up to 3.8W.

### Applications

- Decorative Lighting
- Display Signage
- AC Lighting Panels
- LED Strings for Dome and Mood Lighting
- Instrumentation Illumination

### Key Features

- 2.0V to 60V Wide Input Voltage Range
- An external resistor for 100mA setting (Typ. 7.5kΩ)
- Low Reference Voltage (VRSET = 0.5V)
- Adjustable Sink or Source LED Current Up to 200mA/250mA (W-DFN2020/TO-252)
- ±5% LED Current Tolerance @Room Temp
- Parallel Devices to Increase Regulated Current
- Over Temperature Shutdown
- -40°C to +105°C Ambient Temperature Range
- Wettable W-DFN2020-3 (2mm x 2mm), PDIS up to 1.62W, TO-252 (DPAK), PDIS up to 3.8W
- **Totally Lead-Free & Fully RoHS Compliant**
- **Halogen and Antimony Free “Green” Device**

### AL5810QEV4 Specifications

Parameter	Value
Input Voltage	4.5VDC to 16VDC
LED Current	200mA
Number of LEDs	1~3 pcs
XY Dimension	46mm x 46mm

### EVB Physical Picture



Figure 1. Top View

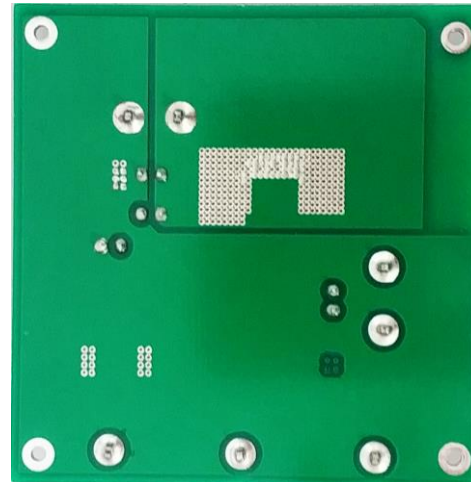


Figure 2. Bottom View

### Connection Instructions

Power Supply Input: 4.5~16V<sub>DC</sub> (VIN, GND);  
 Connect LED string between “HS LED+” and “HS LED-” for high side connection;  
 Connect LED string between “LS LED+” and “LS LED-” for low side connection;  
 For PWM dimming operation: supply a 0-3.3V 200Hz~500Hz signal between PWM & GND.

### Quick Start Guide

1. By default, the LED current of evaluation board is preset at 50mA per channel.
2. Ensure that the DC source is switched OFF or disconnected before soldering or connecting.
3. For LED high side connection
  - Connect the anode wire of external LED string to **HS LED+**;
  - Connect the cathode wire of external LED string to **HS LED-**;
  - J1 & J4 are open, J2&J3 are shorted by Jumper (Default);
  - For PWM dimming operation, J1, J3 & J4 are open, J2 is shorted by Jumper.
4. For LED low side connection
  - Connect the anode wire of external LED string to **LS LED+**;
  - Connect the cathode wire of external LED string to **LS LED-**;
  - J1 & J2 are open, J3&J4 are shorted by Jumper;
  - PWM dimming operation is **NOT** supported in low side connection.
5. Connect two DC line wires to the VIN and GND terminals on the evaluation board.
6. Ensure that the area around the board is clear and safe, and preferably that the board and LEDs are enclosed in a transparent safety cover.
7. Turn on the main switch. LED string should light up.

### Evaluation Board Schematic

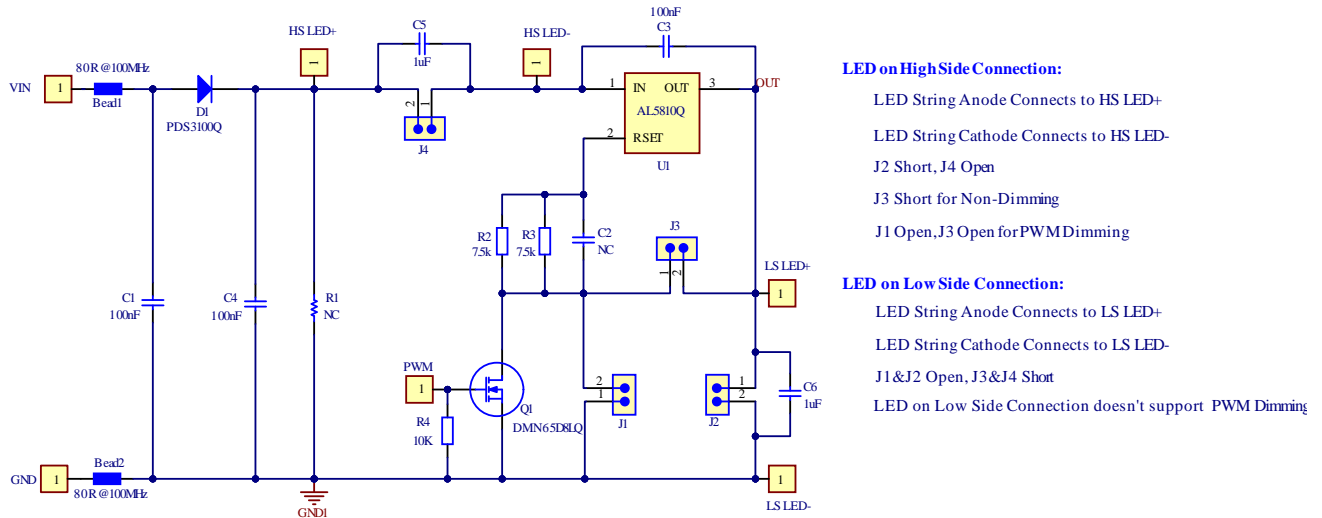


Figure 3. Evaluation Board Schematic

### Evaluation Board Layout

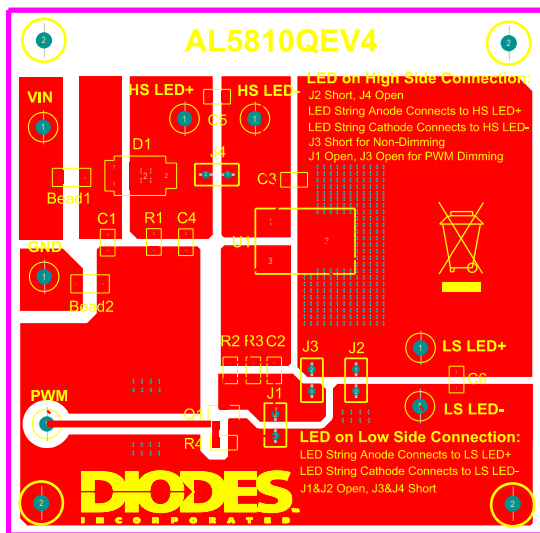


Figure 4. PCB Top Layer View

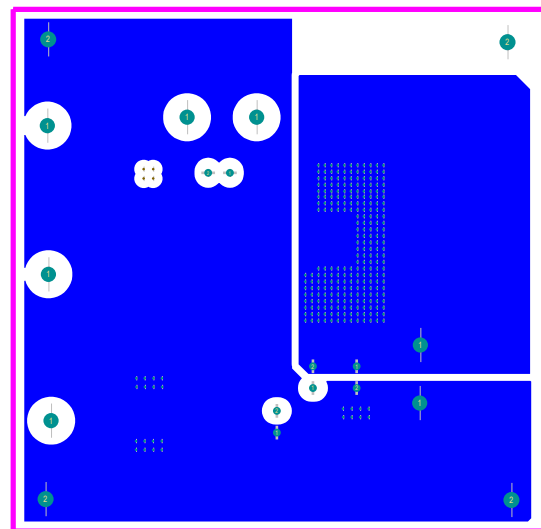


Figure 5. PCB Bottom Layer View

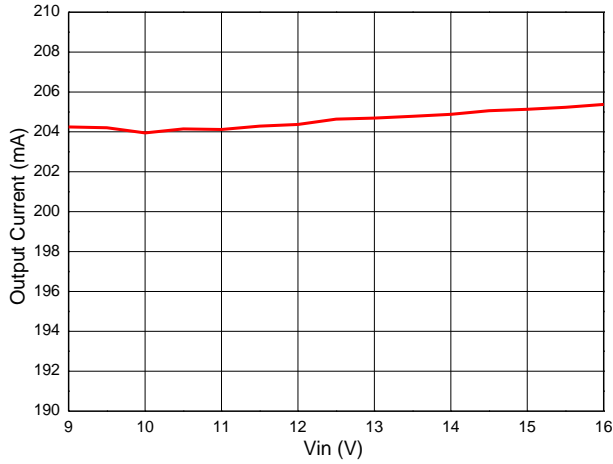
### Bill of Material

Location	Description	Package
R2,R3	7.5KΩ, 1%	0805
R4	10KΩ, 5%	0805
Bead1,Bead2	74279215, 80Ω@100MHz RDC=0.3Ω, AEC-Q200	1206
C5,C6	MLCC, CGA4J3X7R1H105K125AB, 1μF, 50V, X7R, 0805, -55°C ~ +150°C, AEC-Q200, TDK	0805
C1,C3,C4	MLCC, CGA4J2X7R2A104K125AA, 0.1μF, 100V, X7R, 0805, -55°C ~ +125°C, AEC-Q200, TDK	0805
U1	IC, AL5810QD-13, DIODES	TO-252
Q1	MOSFET, DMN65D8LQ, 60V, DIODES	SOT-23
D1	Diode, PDS3100Q-13, DIODES	PowerDI®15
J1,J2,J3,J4	Connector, 2pin, pitch=2mm	DIP
PWM	Connector, Orange color	DIP
HS LED-,LS LED-	Connector, Black color	DIP
GND	Connector, White color	DIP
VIN, HS LED+,LS LED+	Connector, Red color	DIP
J3,J2	2-PIN Jumper, pitch=2mm	

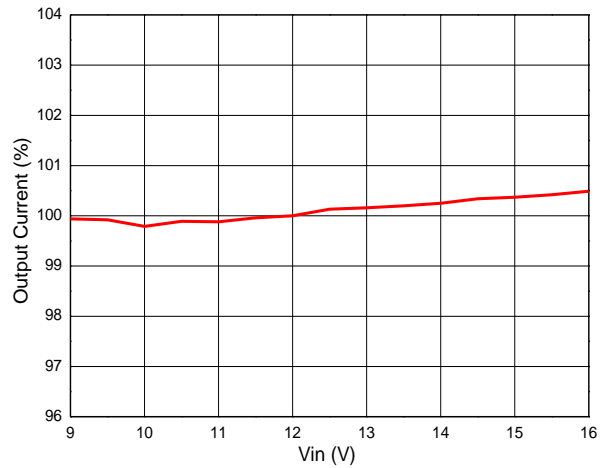
**System Performance**

Test @ LED voltage = 5.46V

**Output Current vs. Vin**



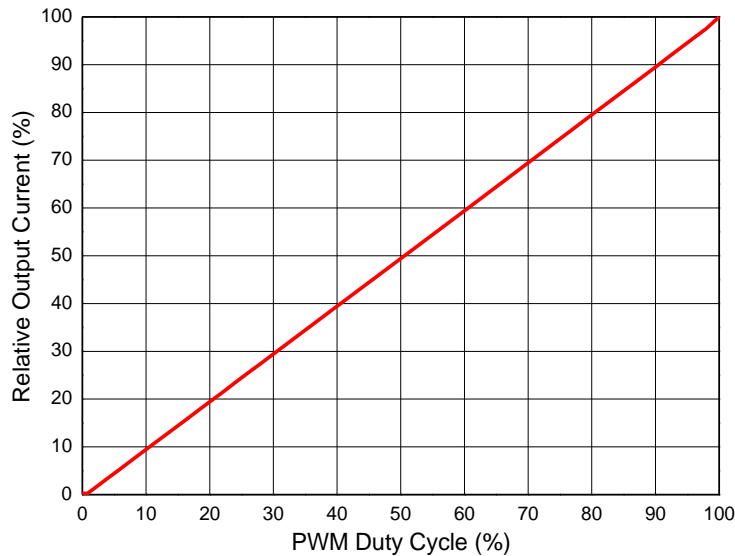
**Relative Output Current vs. Vin**



**PWM Dimming Curve**

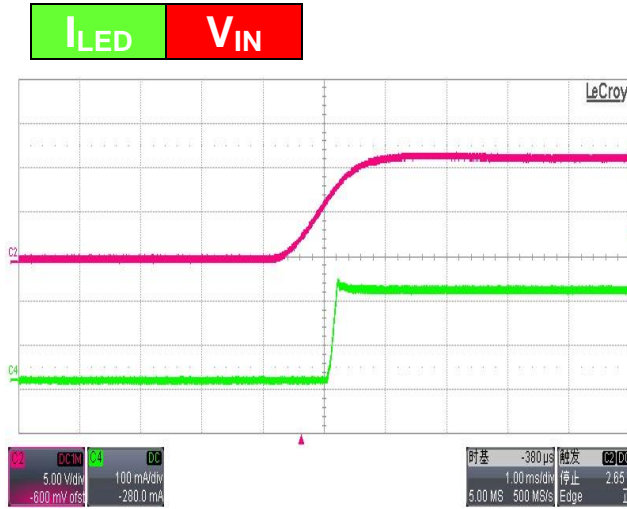
Test @VIN=12V, LED voltage=5.46V

**PWM Dimming Curve (Fpwm=200Hz)**

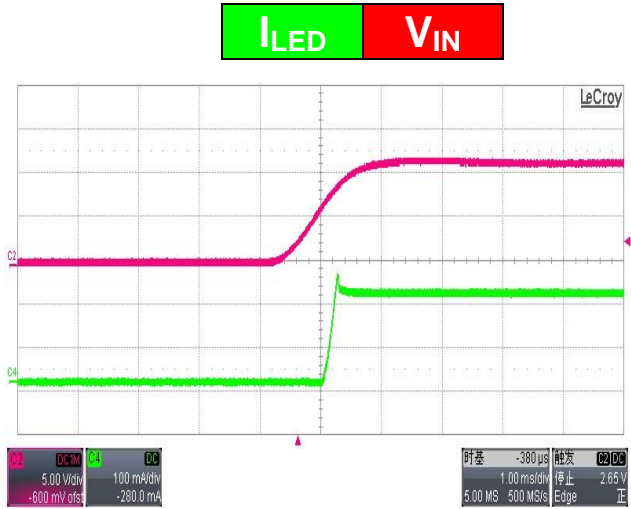


**Waveforms:**

**Turn ON:**

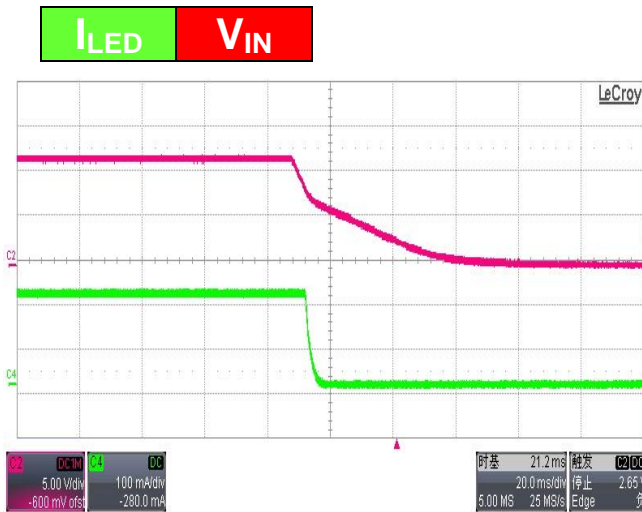


**Figure 6. High Side Startup**

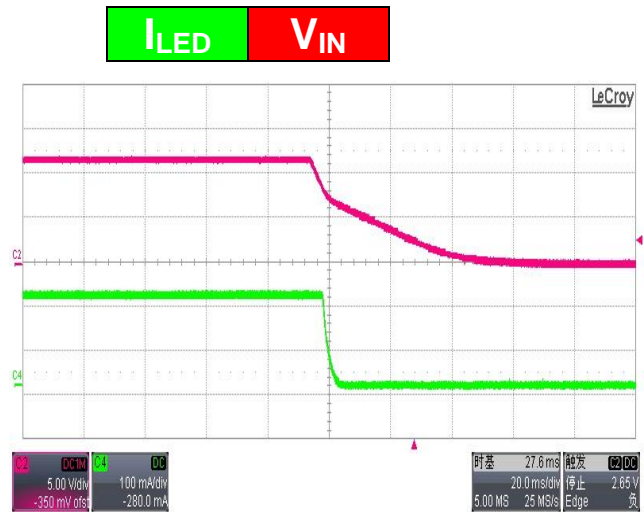


**Figure 7. Low Side Startup**

**Turn OFF:**

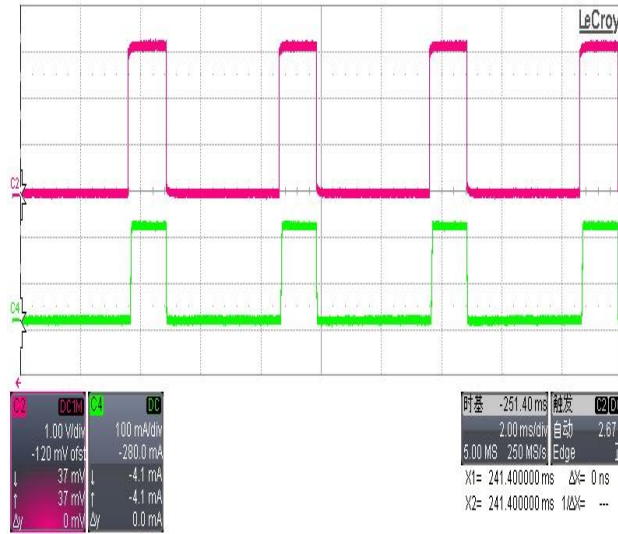


**Figure 8. High Side Turn OFF**



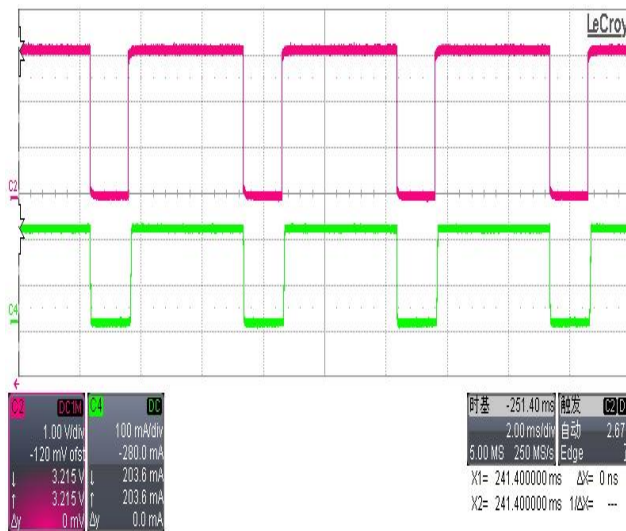
**Figure 9. Low Side Turn OFF**

**I<sub>LED</sub>** **V<sub>PWM</sub>**



**Figure 10. PWM Duty=25%**

**I<sub>LED</sub>** **V<sub>PWM</sub>**



**Figure 11. PWM Duty=75%**

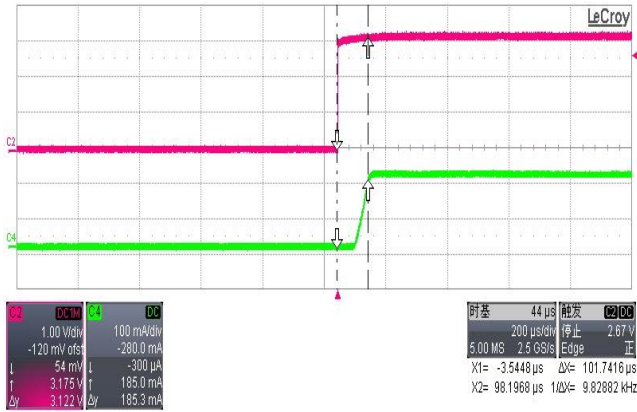


Figure 12. PWM Turn On Delay

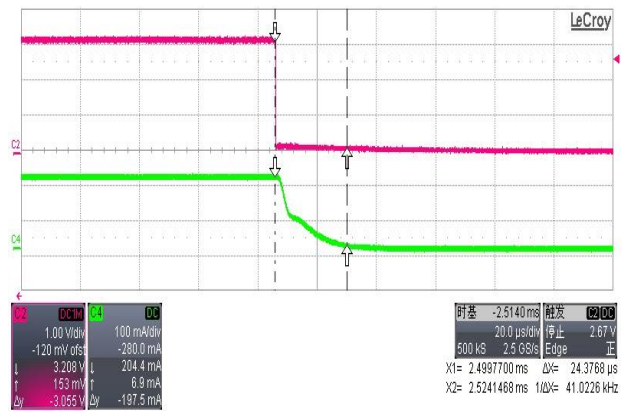


Figure 13. PWM Turn Off Delay

**BCI Test:**

**EVB can pass ISO11452-4 200mA BCI test without LED flicker and output current decrease.**



### IMPORTANT NOTICE

1. DIODES INCORPORATED (Diodes) AND ITS SUBSIDIARIES MAKE NO WARRANTY OF ANY KIND, EXPRESS OR IMPLIED, WITH REGARDS TO ANY INFORMATION CONTAINED IN THIS DOCUMENT, INCLUDING, BUT NOT LIMITED TO, THE IMPLIED WARRANTIES OF MERCHANTABILITY, FITNESS FOR A PARTICULAR PURPOSE OR NON-INFRINGEMENT OF THIRD PARTY INTELLECTUAL PROPERTY RIGHTS (AND THEIR EQUIVALENTS UNDER THE LAWS OF ANY JURISDICTION).
2. The Information contained herein is for informational purpose only and is provided only to illustrate the operation of Diodes' products described herein and application examples. Diodes does not assume any liability arising out of the application or use of this document or any product described herein. This document is intended for skilled and technically trained engineering customers and users who design with Diodes' products. Diodes' products may be used to facilitate safety-related applications; however, in all instances customers and users are responsible for (a) selecting the appropriate Diodes products for their applications, (b) evaluating the suitability of Diodes' products for their intended applications, (c) ensuring their applications, which incorporate Diodes' products, comply the applicable legal and regulatory requirements as well as safety and functional-safety related standards, and (d) ensuring they design with appropriate safeguards (including testing, validation, quality control techniques, redundancy, malfunction prevention, and appropriate treatment for aging degradation) to minimize the risks associated with their applications.
3. Diodes assumes no liability for any application-related information, support, assistance or feedback that may be provided by Diodes from time to time. Any customer or user of this document or products described herein will assume all risks and liabilities associated with such use, and will hold Diodes and all companies whose products are represented herein or on Diodes' websites, harmless against all damages and liabilities.
4. Products described herein may be covered by one or more United States, international or foreign patents and pending patent applications. Product names and markings noted herein may also be covered by one or more United States, international or foreign trademarks and trademark applications. Diodes does not convey any license under any of its intellectual property rights or the rights of any third parties (including third parties whose products and services may be described in this document or on Diodes' website) under this document.
5. Diodes' products are provided subject to Diodes' Standard Terms and Conditions of Sale (<https://www.diodes.com/about/company/terms-and-conditions/terms-and-conditions-of-sales/>) or other applicable terms. This document does not alter or expand the applicable warranties provided by Diodes. Diodes does not warrant or accept any liability whatsoever in respect of any products purchased through unauthorized sales channel.
6. Diodes' products and technology may not be used for or incorporated into any products or systems whose manufacture, use or sale is prohibited under any applicable laws and regulations. Should customers or users use Diodes' products in contravention of any applicable laws or regulations, or for any unintended or unauthorized application, customers and users will (a) be solely responsible for any damages, losses or penalties arising in connection therewith or as a result thereof, and (b) indemnify and hold Diodes and its representatives and agents harmless against any and all claims, damages, expenses, and attorney fees arising out of, directly or indirectly, any claim relating to any noncompliance with the applicable laws and regulations, as well as any unintended or unauthorized application.
7. While efforts have been made to ensure the information contained in this document is accurate, complete and current, it may contain technical inaccuracies, omissions and typographical errors. Diodes does not warrant that information contained in this document is error-free and Diodes is under no obligation to update or otherwise correct this information. Notwithstanding the foregoing, Diodes reserves the right to make modifications, enhancements, improvements, corrections or other changes without further notice to this document and any product described herein. This document is written in English but may be translated into multiple languages for reference. Only the English version of this document is the final and determinative format released by Diodes.
8. Any unauthorized copying, modification, distribution, transmission, display or other use of this document (or any portion hereof) is prohibited. Diodes assumes no responsibility for any losses incurred by the customers or users or any third parties arising from any such unauthorized use.
9. This Notice may be periodically updated with the most recent version available at <https://www.diodes.com/about/company/terms-and-conditions/important-notice>

The Diodes logo is a registered trademark of Diodes Incorporated in the United States and other countries.  
All other trademarks are the property of their respective owners.  
© 2023 Diodes Incorporated. All Rights Reserved.

[www.diodes.com](http://www.diodes.com)