

General Description

This demonstration board utilizes the AL1696 Buck-boost LED driver providing a cost effective triac dimmable solution for offline high brightness LED applications. This user-friendly evaluation board provides users with quick connection to their different types of LEDs string. The demonstration board can be modified easily to adjust the LED output current and the number of series connected LEDs that are driven.

A BOM, schematic and layout are included that describes the parts used on this demonstration board, along with measured performance characteristics. These materials can be used as a reference design.

Key Features

- Triac Dimmable
- Active PFC with power factor >0.88
- High efficiency >84%
- THD<40%

Applications

- Retrofit Candle, GU10 lamps

Specifications

Parameter	Value
AC Input Voltage	108V-132V
Output Power	8.64W
LED Current	120mA
LED Voltage	72V
Power Factor	>0.88
Efficiency	84%
XYZ Dimension	52x21x15mm
ROHS Compliance	Yes

Evaluation Board

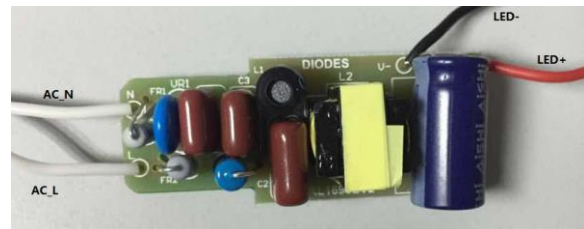

Figure 1: Top View

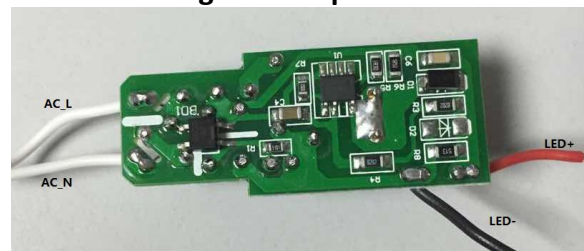

Figure 2: Bottom View

Connection Instructions:

- AC-L Input: Resistor – Hot
- AC-N Input: White– Neutral
- DC LED+ Output: LED+ (Red)
- DC LED- Output: LED- (Black)

Board Layouts

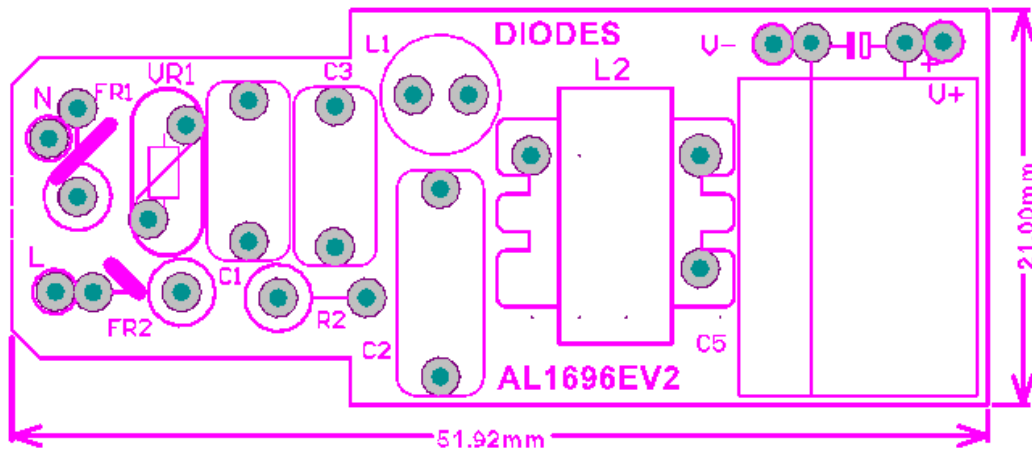

Figure 3: PCB Layout Top View

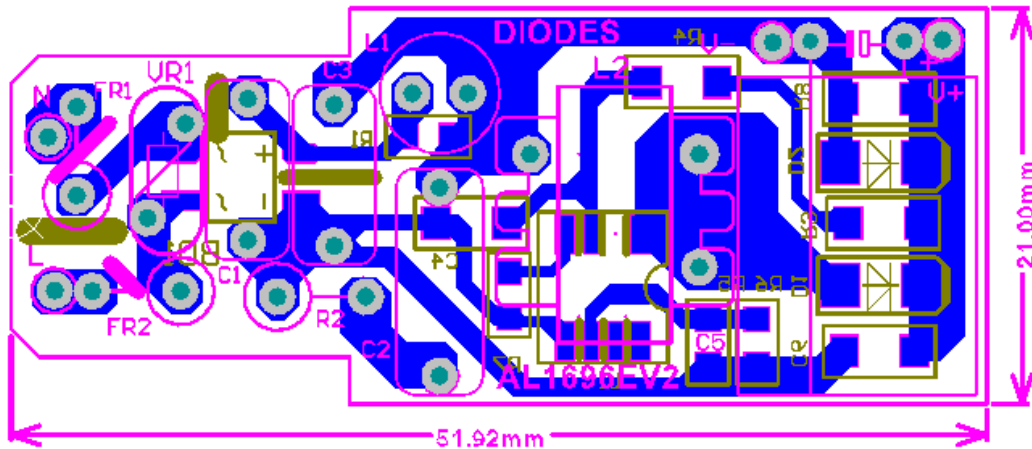

Figure 4: PCB Layout Bottom View

Quick Start Guide

1. Preset the isolated AC source to 120VAC.
2. Ensure that the AC source is switched OFF or disconnected.
3. Connect the anode wire of the LED string to the LED+ terminal of the evaluation board.
4. Connect the cathode wire of the LED string to the LED- terminal of the evaluation board.
5. Connect two AC line wires to the AC-L and AC-N terminals on the evaluation board.
6. Ensure that the area around the board is clear and safe, and preferably that the board and LEDs are enclosed in a transparent safety cover.
7. Turn on the main switch. LED string should light up with LED.
DO NOT TOUCH THE BOARD, LEDs OR BARE WIRING.

Caution: The AL1696 is a non-isolated design. All terminals carry high voltage during operation!

Schematic

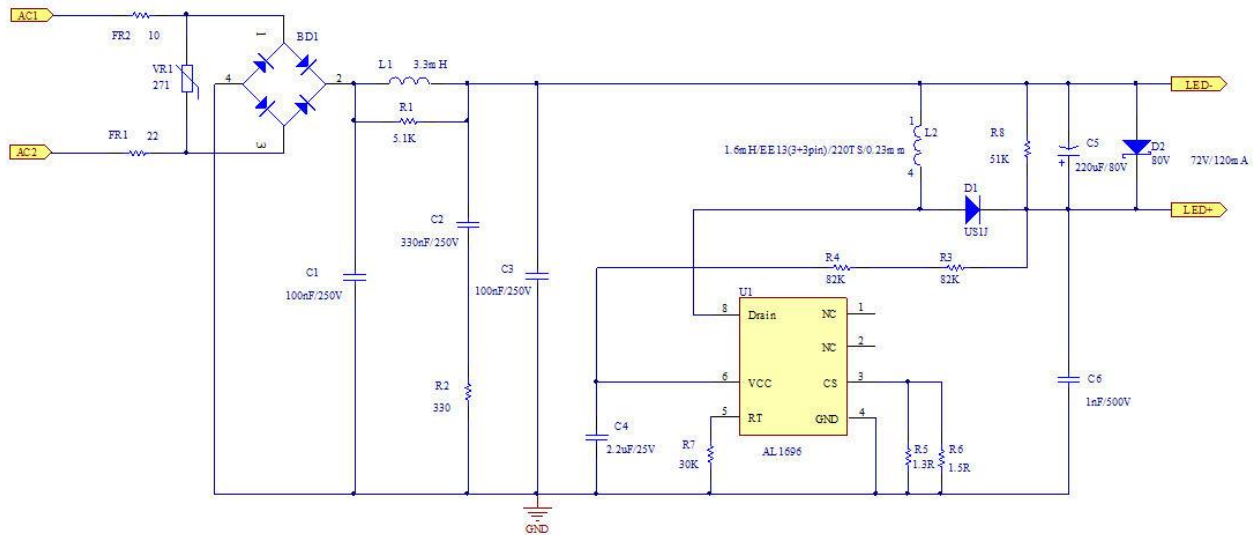
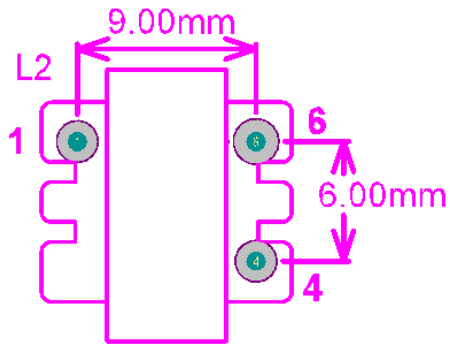
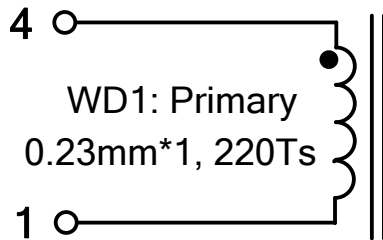

Figure 5: Schematic Circuit

Transformer Design

Bobbin and Core

EE13 Vertical 3+3 pin



Transformer Parameters

1. Primary Inductance (Pin4-Pin1, all other windings open): $L_p=1.6\text{mH}$, $\pm 5\%$ @10kHz
2. Primary Winding Turns (Pin 4-Pin 1): $N_p=220\text{Ts}$

Transformer Winding Construction Diagram

Item	Winding name	Description
1	WD1-Primary Winding	Start at Pin4, Wind 220 turns of $\Phi 0.23\text{mm}$ wire and finish on Pin1.
2	Insulation	3 Layers of insulation tape

Bill of Material

No.	Item	Description	Package	QTY
1	C1	100nF/250V, CL21, Pitch=7.5mm	DIP	1
2	C2	330nF/250V, CL21, Pitch=7.5mm	DIP	1
3	C3	100nF/250V, CL21, Pitch=10mm	DIP	1
4	C4	2.2uF/25V, X7R,0805	0805	1
5	C5	E-Cap, 105°C,220uF/80V, 10*20mm,3000hours	DIP	1
6	C6	1nF/500V, X7R, 1206	1206	1
7	BD1	Rectifier Bridge,HD06,1A/600V SOPA-4	SOPA-4	1
8	D1	Fast Recovery Diode, RS1J, 1A/600V	SMA	1
9	D2	80V Zener Diode	SOD-80	1
10	FR1	Resistor,22R, 5%,1WS	DIP	1
11	FR2	Resistor,10R, 5%,1WS	DIP	1
12	R1	Resistor,5.1K, 5%, 1/4W,0805	0805	1
13	R2	Resistor, 330R, 5%,1W	DIP	1
14	R3,R4	Resistor,82K, 5%, 1/4W,1206	1206	2
15	R5	Resistor,1R3, 1%, 1/4W,1206	1206	1
16	R6	Resistor,1R5, 1%, 1/4W,1206	1206	1
17	R7	Resistor,30K, 1%, 1/8W,0805	0805	1
18	R8	Resistor,51K, 5%, 1/4W,1206	1206	1
19	L1	Inductor 3.3mH, 6*8mm	DIP	1
20	L2	EE13, Horizontal, 3+3 pin 1.6mH/220Ts/0.23mm	DIP	1
21	VR1	Varistor, 07D271	DIP	1
22	U1	AL1696-20B, SOIC-7, Diode's IC 2A/500V	SOIC-7	1
23	PCB	CAM-1 single layer,52*21mm		
Total				23

Functional Performance

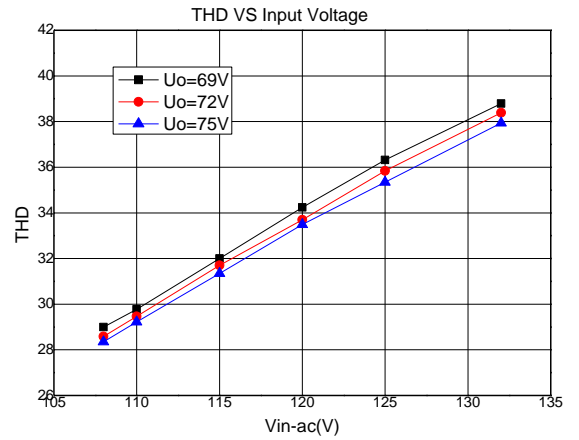
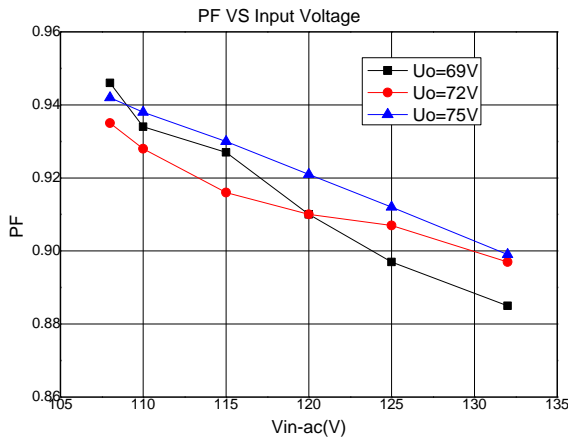
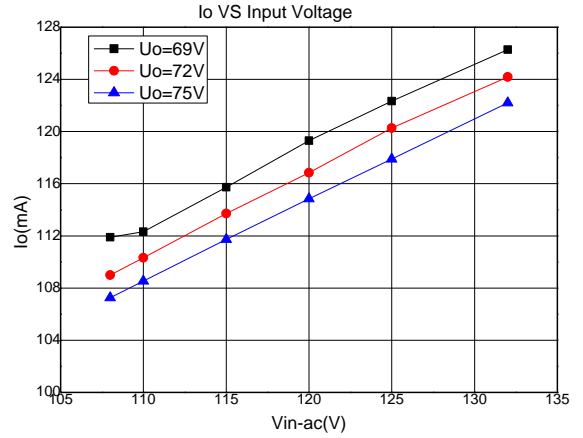
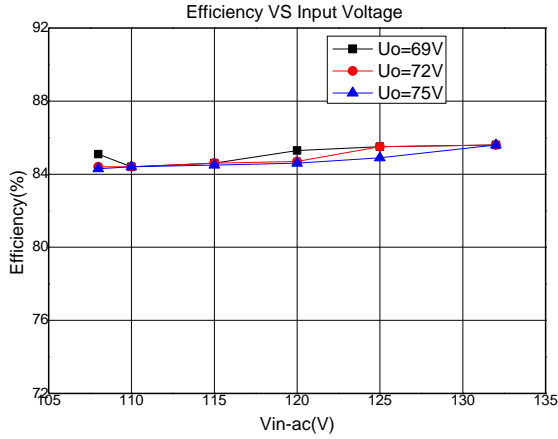

Dimming Test

Dimmer compatibility and dimming range

BoxType	Dimmer Type	Io(mA)		Dimming percentage (%)		Flicker or not?
		min	max	min	max	
Box3	Cooper 9538 L 600W	6.07	84.99	5.14	72.02	N
	Cooper 9539 L 600W	12.84	91.51	10.88	77.55	N
	Cooper SI06P L 600W	3.16	107.57	2.68	91.16	N
	Cooper SI061P L 600W	3.98	84.41	3.38	71.53	N
	Cooper TAL06P L 600W	14.43	113.71	12.23	96.37	N
	Cooper DCL03P L 600W	10.48	113.67	8.88	96.33	N
	Lutron TT-300P L 300W	4.16	105.82	3.53	89.68	N
	ZING EAR ZE-04 L 150W	0.02	116.43	0.02	98.67	N
	Westek 4010 L 300W	6.43	111.53	5.45	94.52	N
Box4	Levltion 6681 L 600 W	1.06	116.33	0.89	98.58	N
	Levltion 6602 L 600 W	20.49	117.23	17.36	99.35	N
	Levltion 6631 L 600 W	0.66	107.66	0.56	91.24	N
	Levltion 6633-P L 600 W	1.77	114.64	1.50	97.15	N
	Levltion 6615-P T 300 W	33.98	114.67	28.80	97.18	N
	Levltion IPE04 T 400 W	24.35	11.37	20.64	9.63	N
	Levltion VPE04 T 400 W	12.76	113.99	10.81	96.60	N
	Levltion IPE06 T 600 W	12.29	113.90	10.42	96.52	N
	Levltion TD06-1 Digital 600 W	8.37	106.39	7.10	90.16	N
	Levltion 6681 L 600 W	3.76	99.17	3.19	84.04	N
Box5	Lutron DV-10P L 1000W	9.26	107.96	7.84	91.49	N
	Lutron DVLV-10P L 100	12.53	101.67	10.62	86.16	N
	Lutron DV-603P L 600W	4.73	102.87	4.01	87.18	N
	Lutron DVCV-153P L 150W	0.17	99.16	0.14	84.04	N
	Lutron N-600L 600W	5.89	111.36	4.99	94.37	N
	Lutron NT-600L 600W	7.94	111.27	6.73	94.29	N
	Lutron VT-600 Digital 600W	5.68	100.15	4.81	84.87	N
	Lutron CT-603PG L 600W	15.08	104.19	12.78	88.29	N

Lutron CTCL-153P L 150W	7.57	84.62	6.42	71.72	N
Lutron CT-603PG L 600W	0.15	98.86	0.12	83.78	N

Dimming Curve

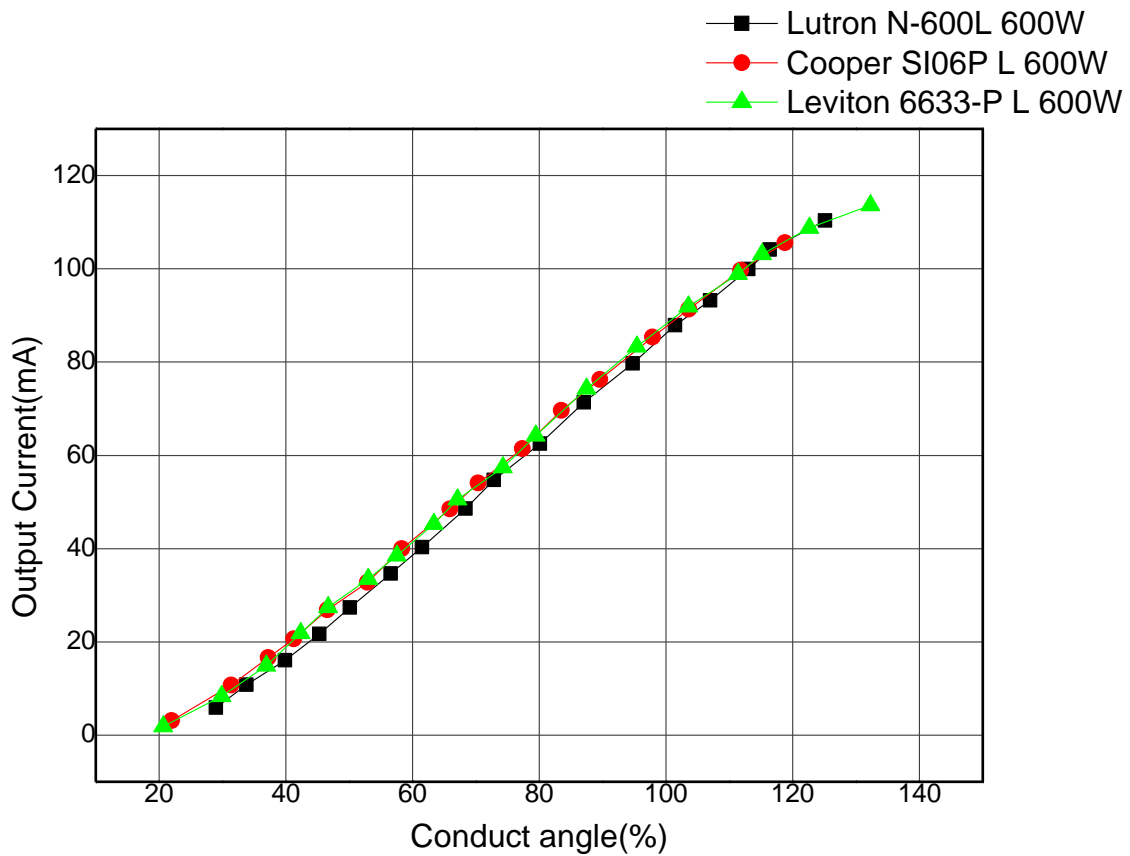

Functional Waveform

Input Voltage & Input Current
($V_{in}=120V/60Hz$)

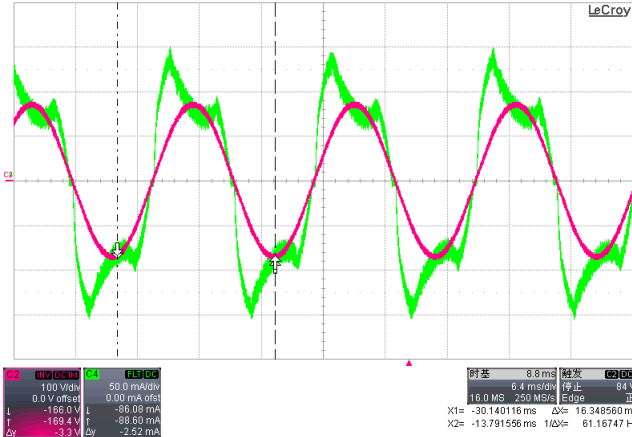

LED Current Ripple
($V_{in}=120V_{AC}/60Hz$ Ripple=29mA)

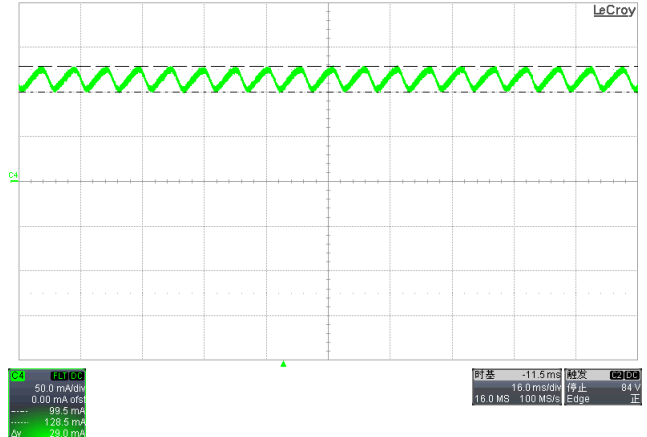

Input AC Current vs Dimmer Phase
($V_{in}=120V_{AC}/60Hz$, Conduction Angle 133.5deg)



Input AC Current vs Dimmer Phase
($V_{in}=120V_{AC}/60Hz$, Conduction angle 90deg)

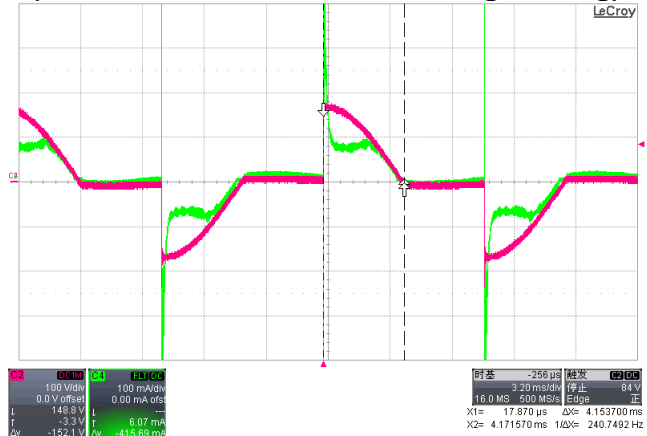

Input AC Current vs Dimmer Phase
($V_{in}=120V_{AC}/60Hz$, Conduction angle 45deg)

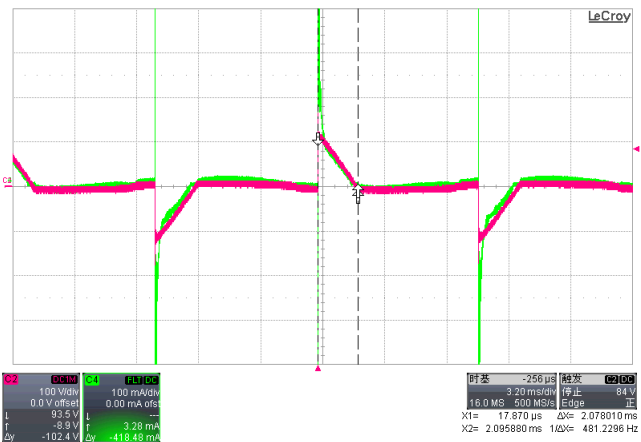

Start-up time
($V_{in}=108V_{AC}/60Hz$, Start-up time=165.2ms)

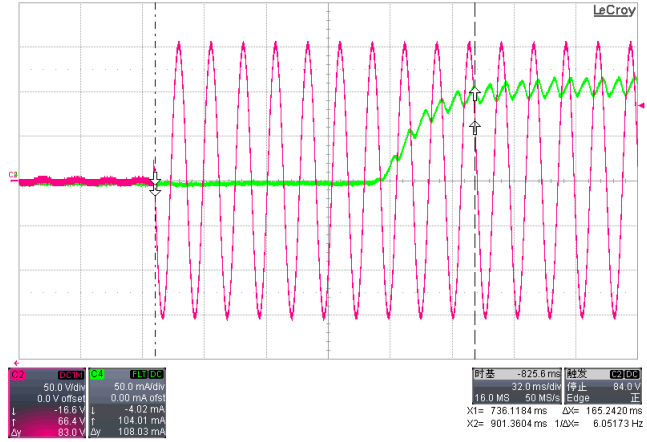

LED Short Protection(Vin=120VAC/60Hz) R-VCC,Y-Vgate,B-Vout,G-ILED

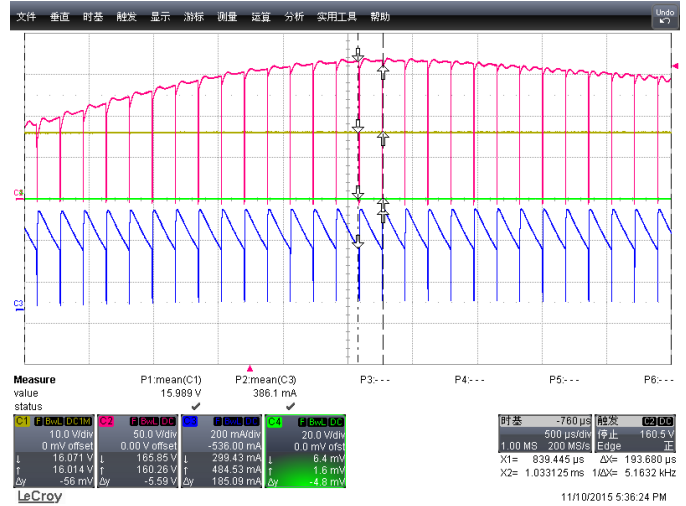

EMI Conduction Test

Line Terminal
(Vin=120VAC, Margin>6dB)

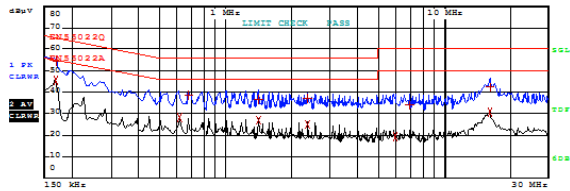
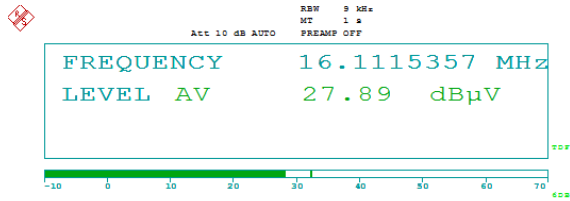

Date: 3.JUL.2015 16:00:39

Neutral Terminal
(Vin=120VAC, Margin>6dB)

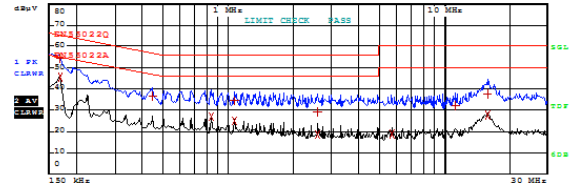
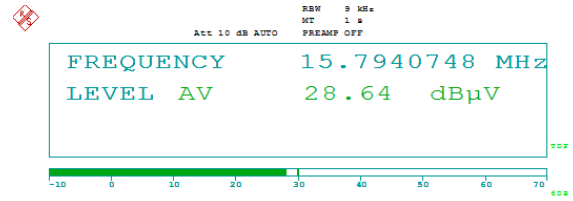

Date: 3.JUL.2015 16:04:08

EDIT PEAK LIST (Final Measurement Results)			
Trace1:	EN55022Q		
Trace2:	EN55022A		
Trace3:	---		
TRACE	FREQUENCY	LEVEL dB μ V	DELTA LIMIT dB
2 Average	167.350252 kHz	45.65	-9.44
1 Quasi Peak	169.02375452 kHz	54.40	-10.60
2 Average	616.206586648 kHz	28.24	-17.75
1 Quasi Peak	673.936068749 kHz	38.37	-17.63
1 Quasi Peak	1.4073443054 MHz	36.74	-19.25
2 Average	1.4073443054 MHz	26.93	-19.06
1 Quasi Peak	2.36108594985 MHz	37.06	-18.93
2 Average	2.36108594985 MHz	24.88	-21.11
2 Average	5.95661538167 MHz	19.53	-30.46
1 Quasi Peak	6.9154455372 MHz	33.78	-26.21
1 Quasi Peak	16.1115356609 MHz	42.54	-17.45
2 Average	16.1115356609 MHz	30.79	-19.20

EDIT PEAK LIST (Final Measurement Results)			
Trace1:	EN55022Q		
Trace2:	EN55022A		
Trace3:	---		
TRACE	FREQUENCY	LEVEL dB μ V	DELTA LIMIT dB
1 Quasi Peak	167.350252 kHz	54.56	-10.52
2 Average	167.350252 kHz	45.56	-9.52
1 Quasi Peak	448.169580165 kHz	36.64	-20.26
2 Average	838.85881323 kHz	27.06	-18.93
1 Quasi Peak	1.06512822736 MHz	34.44	-21.55
2 Average	1.06512822736 MHz	25.22	-20.77
1 Quasi Peak	2.58228493089 MHz	29.07	-26.92
2 Average	2.58228493089 MHz	18.62	-27.37
2 Average	5.66751514993 MHz	19.12	-30.87
1 Quasi Peak	11.2607542502 MHz	31.98	-28.01
1 Quasi Peak	15.7940747583 MHz	37.59	-22.40
2 Average	15.7940747583 MHz	27.94	-22.05

IMPORTANT NOTICE

DIODES INCORPORATED MAKES NO WARRANTY OF ANY KIND, EXPRESS OR IMPLIED, WITH REGARDS TO THIS DOCUMENT, INCLUDING, BUT NOT LIMITED TO, THE IMPLIED WARRANTIES OF MERCHANTABILITY AND FITNESS FOR A PARTICULAR PURPOSE (AND THEIR EQUIVALENTS UNDER THE LAWS OF ANY JURISDICTION).

Diodes Incorporated and its subsidiaries reserve the right to make modifications, enhancements, improvements, corrections or other changes without further notice to this document and any product described herein. Diodes Incorporated does not assume any liability arising out of the application or use of this document or any product described herein; neither does Diodes Incorporated convey any license under its patent or trademark rights, nor the rights of others. Any Customer or user of this document or products described herein in such applications shall assume all risks of such use and will agree to hold Diodes Incorporated and all the companies whose products are represented on Diodes Incorporated website, harmless against all damages.

Diodes Incorporated does not warrant or accept any liability whatsoever in respect of any products purchased through unauthorized sales channel.

Should Customers purchase or use Diodes Incorporated products for any unintended or unauthorized application, Customers shall indemnify and hold Diodes Incorporated and its representatives harmless against all claims, damages, expenses, and attorney fees arising out of, directly or indirectly, any claim of personal injury or death associated with such unintended or unauthorized application.

Products described herein may be covered by one or more United States, international or foreign patents pending. Product names and markings noted herein may also be covered by one or more United States, international or foreign trademarks.

LIFE SUPPORT

Diodes Incorporated products are specifically not authorized for use as critical components in life support devices or systems without the express written approval of the Chief Executive Officer of Diodes Incorporated. As used herein:

A. Life support devices or systems are devices or systems which:

1. are intended to implant into the body, or
2. support or sustain life and whose failure to perform when properly used in accordance with instructions for use provided in the labeling can be reasonably expected to result in significant injury to the user.

B. A critical component is any component in a life support device or system whose failure to perform can be reasonably expected to cause the failure of the life support device or to affect its safety or effectiveness.

Customers represent that they have all necessary expertise in the safety and regulatory ramifications of their life support devices or systems, and acknowledge and agree that they are solely responsible for all legal, regulatory and safety-related requirements concerning their products and any use of Diodes Incorporated products in such safety-critical, life support devices or systems, notwithstanding any devices- or systems-related information or support that may be provided by Diodes Incorporated. Further, Customers must fully indemnify Diodes Incorporated and its representatives against any damages arising out of the use of Diodes Incorporated products in such safety-critical, life support devices or systems.

Copyright © 2015, Diodes Incorporated

www.diodes.com