

FIXED 2.5 AND 5 VOLT 3-TERMINAL VOLTAGE REFERENCES

ZTR250
ZTR500

ISSUE 4 - MARCH 1998

DEVICE DESCRIPTION

The ZTR250 and ZTR500 are precision three terminal references. These devices are ideal for battery powered applications where power saving is important. They offer low power alternatives to other two terminal shunt references.

The ZTR devices do not require an external resistor and, in contrast to two terminal references, waste none of the battery power as load current varies. The ZTR only consumes 30 μ A supply current.

The two devices require as low as 1.4 volts between input and output for regulation. Output voltage tolerance is $\pm 2.5\%$, with a voltage variation of 0.275mV/ $^{\circ}$ C over the -55 $^{\circ}$ C to 125 $^{\circ}$ C operating range.

FEATURES

- Small outline SOT23 and SOT89 packages
- TO92 package
- 2.5V and 5V output
- 2.5% tolerance
- Supply current independent of input voltage over temperature
- Output current up to 50mA
- Very low supply current (30 μ A)
- Unconditionally stable
- Internal short circuit current limit

APPLICATIONS

- Battery Powered Systems
- Portable and Hand Held Equipment
- Instrumentation
- Metering

SCHEMATIC DIAGRAM

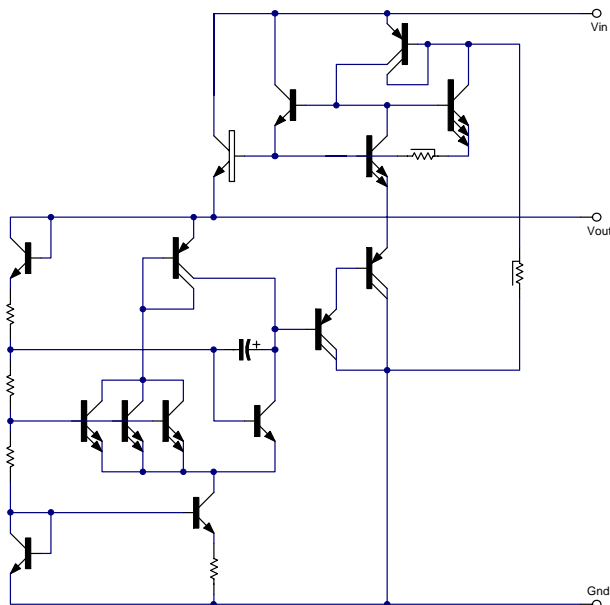

ZTR250
ZTR500

ABSOLUTE MAXIMUM RATINGS

Input Voltage	20V	Power Dissipation ($T_{amb}=25^{\circ}\text{C}$, $T_{jmax}=150^{\circ}\text{C}$)	
Output current (I_O)	200mA	SOT23	500mW
Operating temperature	-55 to 125°C	TO92	600mW
Storage temperature	-65 to 150°C	SOT89	1.5W

Note:

1. The maximum operating input voltage and output current of the device will be governed by the maximum power dissipation of the selected package. Maximum package power dissipation is specified at 25 °C and must be linearly derated to zero at $T_{amb}=125^{\circ}\text{C}$.
2. The following data represents pulse test conditions with junction temperatures as indicated at the initiation of the test. Continuous operation of the devices with the stated conditions might exceed the power dissipation limits of the chosen package.
3. This device does not contain a thermal shutdown circuit so care should be taken not to exceed the stated maximum power dissipation rating. Maximum power dissipation, for the SOT23 and SOT89 packages, is calculated assuming that the device is mounted on a ceramic substrate measuring 15 x 15 x 0.6mm.

ZTR250

ELECTRICAL CHARACTERISTICS

TEST CONDITIONS (Unless otherwise stated): $T_j=25^{\circ}\text{C}$, $I_O=10\text{mA}$, $V_{in}=6.5\text{V}$

SYMBOL	PARAMETER	CONDITIONS	MIN.	TYP.	MAX.	UNITS
V_O	Output Voltage		2.438	2.5	2.563	V
		$I_O=0$ to 50mA $T_j=-55$ to 125°C	2.360		2.640	V
		$V_{in}=4.5$ to 20V $I_O=0$ to 50mA $T_j=-55$ to 125°C	2.360		2.640	V
ΔV_O	Line Regulation	$V_{in}=4.5$ to 20V		5	15	mV
ΔV_O	Load Regulation	$I_O=0$ to 50mA		20	30	mV
		$I_O=0$ to 10mA		12		mV
I_s	Supply Current	$T_j=-55$ to 125°C		30	40	μA
ΔI_s	Supply Current Change	$I_O=0$ to 50mA		1	± 10	μA
		$V_{in}=4.5$ to 20V		2	10	μA
V_n	Output Noise Voltage	$f=10\text{Hz}$ to 10kHz		65		μV (rms)
$\Delta V_{in}/\Delta V_O$	Ripple Rejection	$V_{in}=6.3$ to 18V $f=120\text{Hz}$	55	75		dB
V_{in}	Input Voltage Required To Maintain Regulation		4.2	3.9		V
$\Delta V_O/\Delta T$	Average Temperature Coefficient of V_O	$I_O=5.0\text{mA}$ $T_j=-55$ to 125°C		0.275	0.700	mV/°C

ZTR250 ZTR500

ZTR500

ELECTRICAL CHARACTERISTICS

TEST CONDITIONS (Unless otherwise stated): $T_j=25^{\circ}\text{C}$, $I_O=10\text{mA}$, $V_{in}=10\text{V}$

SYMBOL	PARAMETER	CONDITIONS	MIN.	TYP.	MAX.	UNITS
V_O	Output Voltage		4.875	5	5.125	V
		$I_O=0$ to 50mA $T_j=-55$ to 125°C	4.780		5.160	V
		$V_{in}=7$ to 20V $I_O=0$ to 50mA $T_j=-55$ to 125°C	4.780		5.175	V
ΔV_O	Line Regulation	$V_{in}=7$ to 20V		5	15	mV
ΔV_O	Load Regulation	$I_O=0$ to 50mA		25	40	mV
		$I_O=0$ to 10mA		15		mV
I_s	Supply Current	$T_j=-55$ to 125°C		50	70	μA
ΔI_s	Supply Current Change	$I_O=0$ to 50mA $V_{in}=7$ to 20V		1	± 10	μA
				2	10	μA
V_n	Output Noise Voltage	$f=10\text{Hz}$ to 10kHz		90		μV (rms)
$\Delta V_{in}/\Delta V_O$	Ripple Rejection	$V_{in}=8$ to 18V $f=120\text{Hz}$	55	72		dB
V_{in}	Input Voltage Required To Maintain Regulation		7	6.7		V
$\Delta V_O/\Delta T$	Average Temperature Coefficient of V_O	$I_O=5.0\text{mA}$ $T_j=-55$ to 125°C		0.275	0.700	$\text{mV}/^{\circ}\text{C}$

ZTR250
ZTR500

TYPICAL CHARACTERISTICS a=ZTR250: b=ZTR500

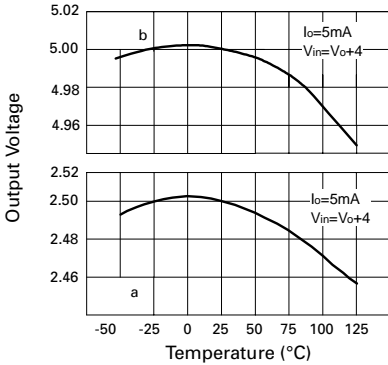

Output Voltage Temperature

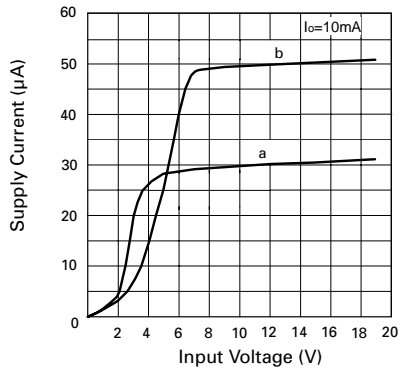

Supply Current v Voltage

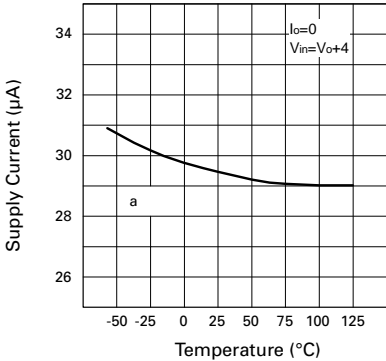

Supply Current v Temperature

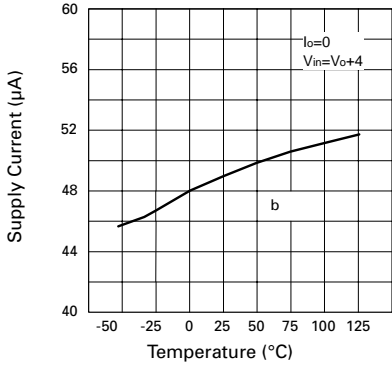

Supply Current v Temperature

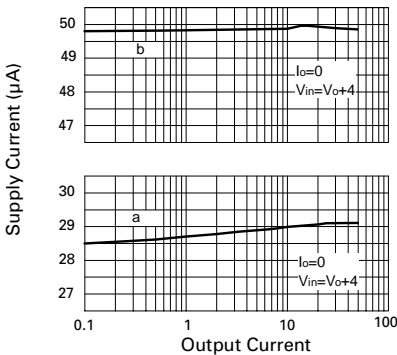

Supply Current v Output Current

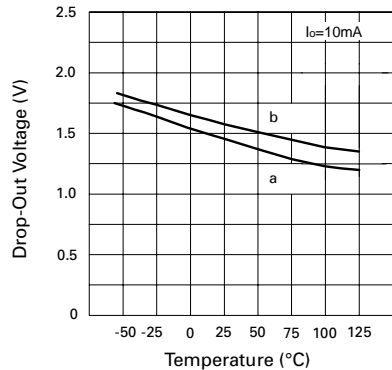

Drop-Out Voltage v Temperature

ZTR250 ZTR500

TYPICAL CHARACTERISTICS a=ZTR250: b=ZTR500

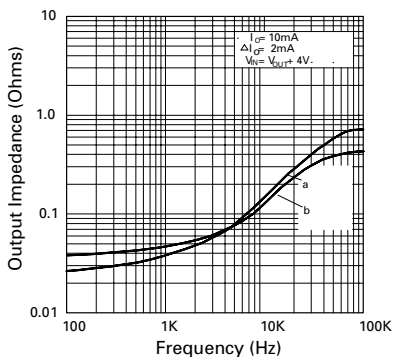

Output Impedance v Frequency

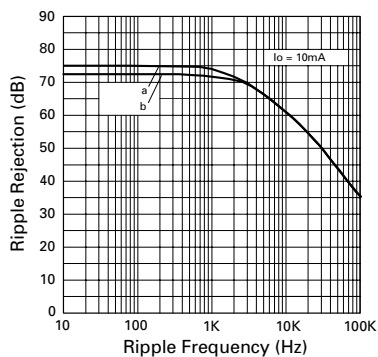

Ripple Rejection v Ripple Frequency

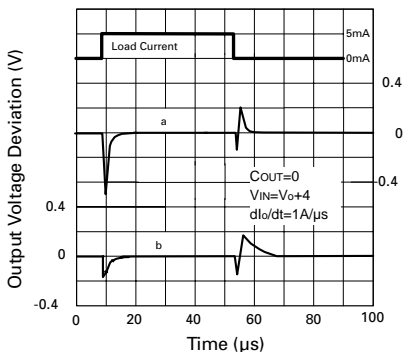

Load Transient Response

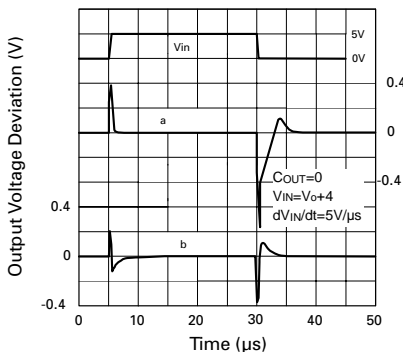

Line Transient Response

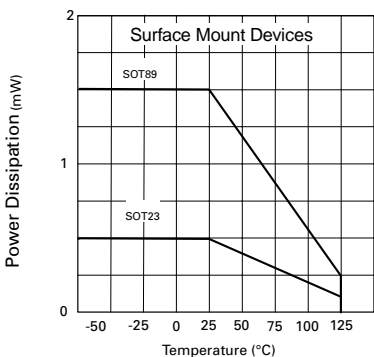

Power Derating

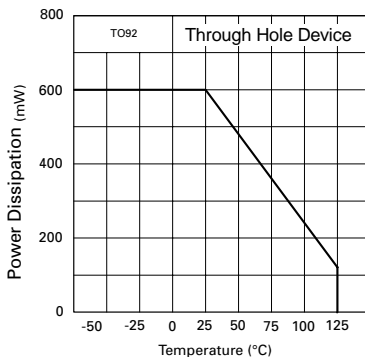

Power Derating

ZTR250
ZTR500

CONNECTION DIAGRAMS

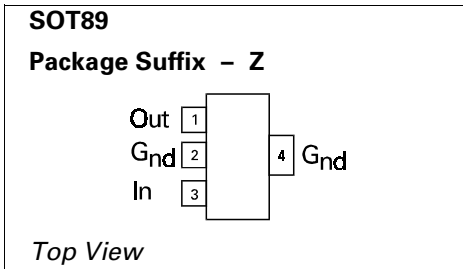
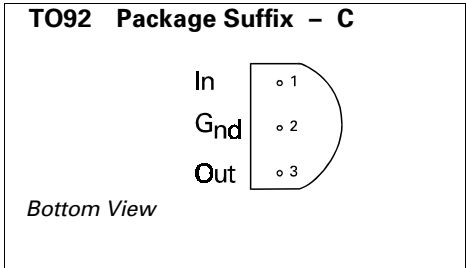
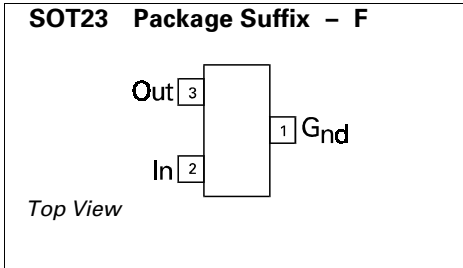

ORDERING INFORMATION

Part Number	Tol %	Package	Part Mark
ZTR250C02	2.5	TO92	ZTR25002
ZTR250F02	2.5	SOT23	25U
ZTR250Z02	2.5	SOT89	25U
ZTR500C02	2.5	TO92	ZTR50002
ZTR500F02	2.5	SOT23	50N
ZTR500Z02	2.5	SOT89	50N