

Features

- Output Current: 300mA or more
- Dropout Voltage: 270mV @ 300mA for 3.3V
- Operating Voltage Range: 1.8 to 5.5V
- Output Voltage Range: 1.2 to 3.3V (100mV Step)
- Low Power Consumption: 65µA
- High Ripple Rejection: 75dB @ 1kHz
- Output Current-Limit Protection
- Thermal Shutdown Protection
- Operating Temperature Range: -40 °C to +85 °C
- Low ESR Capacitor Compatible: Ceramic Capacitor
- Lead Free Package: SOT23-3L Ultra-Low-Noise for RF Application:
- 30µV RMS @ 1.2V
- Quick Start-Up (Typically 50µs)
- Dropout Voltage: 70270mV @ 1300mA for 3.3V
- Wide Operating Voltage Range: 1.8V ---to 5.5V
- Output Voltage Range: 1.2V to 3.3V(100 mV Step)
- Highly Accurate: ±2.0%
- Low Power Consumption: 7050µA
- Standby Current: 0.1 µA
- High Ripple Rejection: 80dB @ 1kHz
- Output Current-Limit Protection
- Thermal Shutdown Protection
- Auto Output Discharge
- Operating Temperature Range: -40°C ~ +85°C
- Low ESR Capacitor compatible: Ceramic capacitor
- Lead Free and Green Package: SOT23-3L

Applications

- Mobile phones (GSM, CDMA, WCDMA, CDMA2000 etc.)
- Cordless phones and radio communication
- Digital still cameras and video cameras
- PDAs
- MP3/MP4 players
- Portable devices

Description

The output voltage for the regulator is set by factory trimming within a range of 1.2V to 3.3V in 100mV step includes 2.85V. The PT7M8202 series are stable with low ESR ceramic capacitors. The PT7M8205 series are highly accurate, low dropout voltage regulators with low noise, high ripple rejection and low current consumption. The PT7M8205 includes a reference voltage source, an error amplifier, a driver transistor, a current limit protection, a thermal protection and an internal phase compensator.

The output voltage for the regulator is set by factory trimming within a range of 1.2V to 3.3V in 100mV step includes 2.85V. The PT7M8205 series are stable with low ESR ceramic capacitors.

Pin Configuration

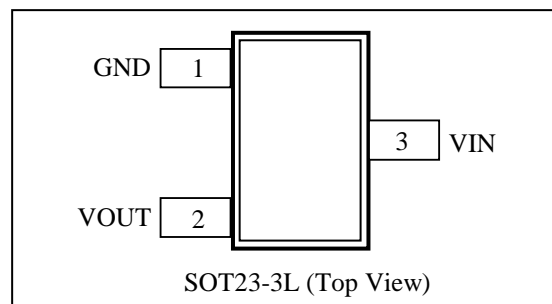

Pin Description

Pin No.	I/O	Name	Descriptions
1	P	GND	Ground.
2	O	VOUT	Output of Regulator. Bypass with a 1µF ceramic capacitor (X5R/X7R) to GND.
3	I	VIN	Regulator Supply Input. Supply voltage can range from 1.8V to 5.5V. Bypass with a 1µF ceramic capacitor (X5R/X7R) to GND.

Maximum Ratings

Storage Temperature.....	-55°C to +125°C
Ambient Temperature with Power Applied.....	-40°C to +85°C
Input Voltage.....	+6.0V
Output Voltage	-0.3 to V _{CC} +0.3V
DC Input/Output Current	700mA
Power Dissipation.....	SOT23/400mW

Note:

Stresses greater than those listed under MAXIMUM RATINGS may cause permanent damage to the device. This is a stress rating only and functional operation of the device at these or any other conditions above those indicated in the operational sections of this specification is not implied. Exposure to absolute maximum rating conditions for extended periods may affect reliability.

Recommended Operating Conditions

Symbol	Parameter	Min.	Typ.	Max.	Unit
V _{CC}	Operating Voltage	1.8	-	5.5	V
T _A	Operating temperature	-40	25	85	°C

Electrical Characteristics (T_A=25°C)

Parameter	Symbol	Conditions	Min.	Typ.	Max.	Unit	
Output Voltage	V _{OUT(E)} *2	V _{IN} =V _{OUT(S)} *1+1.0V, I _{OUT} =30mA	V _{OUT(S)} *0.98	V _{OUT(S)}	V _{OUT(S)} *1.02	V	
Maximum Output Current	I _{OUTMAX}	V _{IN} =V _{OUT(S)} +1.0V	300	-	-	mA	
Dropout Voltage	V _{DIF} *3	I _{OUT} = 300mA	1.7V≤V _{OUT(S)} ≤1.8V	-	0.39	0.51	V
			1.9V≤V _{OUT(S)} ≤2.3V	-	0.33	0.43	
			2.4V≤V _{OUT(S)} ≤2.7V	-	0.30	0.39	
			2.8V≤V _{OUT(S)} ≤3.3V	-	0.27	0.35	
Supply Current	I _{SS}	V _{IN} = V _{OUT(S)} +1.0V, no load	-	750650	85100	µA	
Line Regulation	$\frac{\Delta V_{OUT}}{\Delta V_{IN}} * V_{OUT}$	V _{OUT(S)} +1.0V≤V _{IN} ≤5.5V I _{OUT} =30 mA	-	0.05	0.2	%/V	
Load Regulation	ΔV_{OUT2}	V _{IN} = V _{OUT(S)} +1.0V, 1.0mA≤I _{OUT} ≤100mA300mA	-	8	0.620	mV%	
Input Voltage	V _{IN}	-	1.8	-	5.5	V	
Output Voltage Temperature Characteristic	$\frac{\Delta V_{OUT}}{\Delta T_{opr}} * V_{OUT}$	I _{OUT} =30 mA -40°C≤T _{opr} ≤85°C	-	+/-100	-	ppm/°C	
Ripple Rejection	PSRR	V _{IN} =[V _{OUT(S)} +1.0]V _{DC} +1Vp-p AC V _{OUT} =1.5V, I _{OUT} =30mA, f=1kHz	-	708075	-	dB	
Current Limit	I _{LIM}	V _{OUT} = V _{OUT(S)} *0.9	-400	450	-600	mA	
Thermal Shutdown	T _{SD}	-	-	170	-	°C	
Thermal Shutdown Hysteresis	ΔT _{SD}	-	-	40	-		
Output Discharge Resistance	R _{dis}	V _{IN} = V _{OUT(S)} +1.0V, EN=OFF	-	1	-	k Ω	
Output Noise Voltage	e _{ON}	VO=1.2V, , 10Hz to 100kHz, I _{OUT} =20300mA, C _{OUT} =1 µF	-	730	-	µV _{RMS}	

Note:

- *1: V_{OUT(S)}=Specified output voltage.
- *2: V_{OUT(E)}=Effective output voltage.
(I.e. the output voltage when "V_{OUT(S)}+1.0V" is provided at the VIN pin while maintaining a certain I_{OUT} value).
- *3: V_{dif}={V_{IN1} (*5)-V_{OUT1} (*4)}.
- *4: V_{OUT1}=A voltage equal to 98% of the output voltage whenever an amply stabilized I_{OUT} {V_{OUT(S)}+1.0V} is input.
- *5: V_{IN1}=The input voltage when V_{OUT1} appears as input voltage is gradually decreased.
- *6: Unless otherwise statednoted, V_{IN}=V_{OUT(S)}+1.0V

Application Circuit

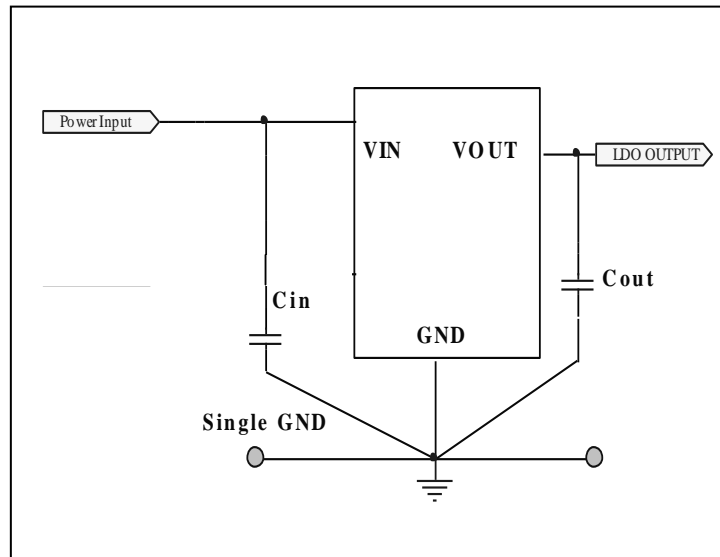

Note: $C_{in}=C_{out}=1\ \mu\text{F}$

Typical Performance and Characteristics

1. Output Voltage vs. Output Current

PT7M82025 (1.2V)

$C_{in}=1\ \mu\text{F}$ (Ceramics), $C_{out}=1\ \mu\text{F}$ (Ceramics)

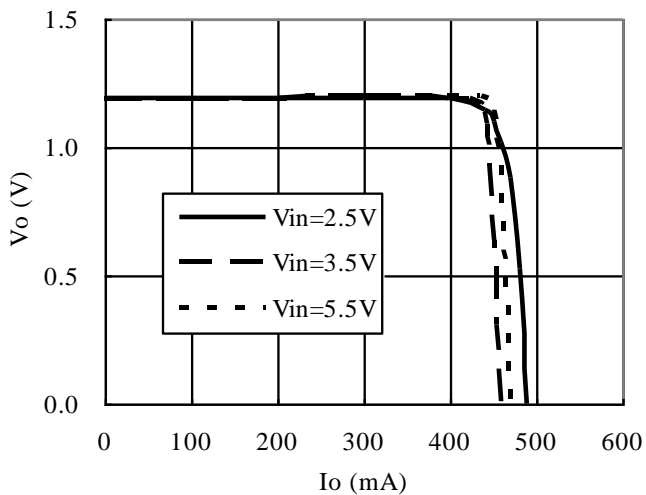

PT7M82025 (3.3V)

$C_{in}=1\ \mu\text{F}$ (Ceramics), $C_{out}=1\ \mu\text{F}$ (Ceramics)

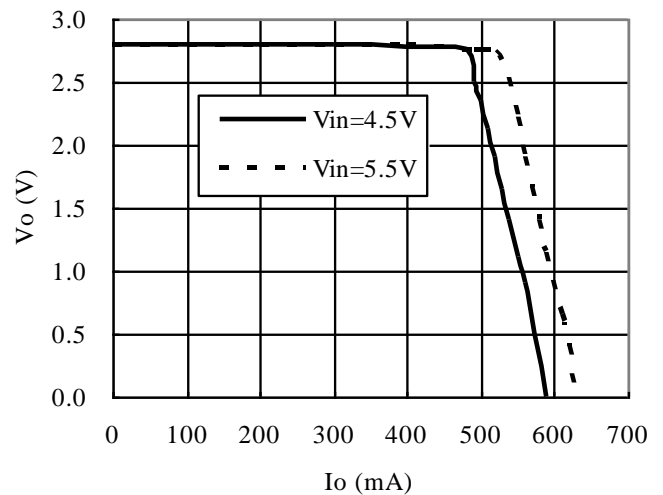

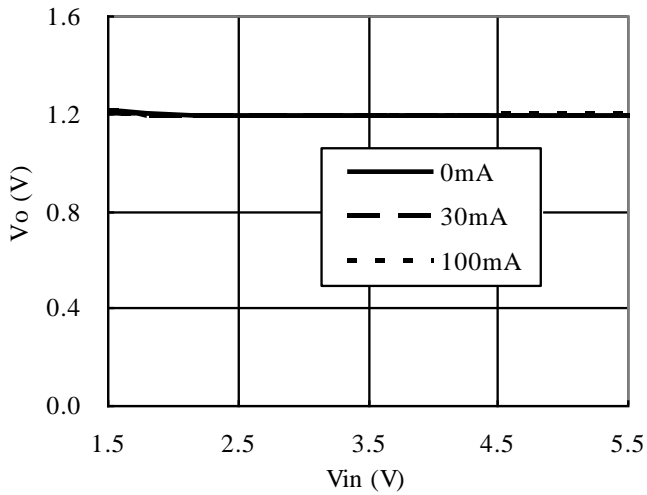
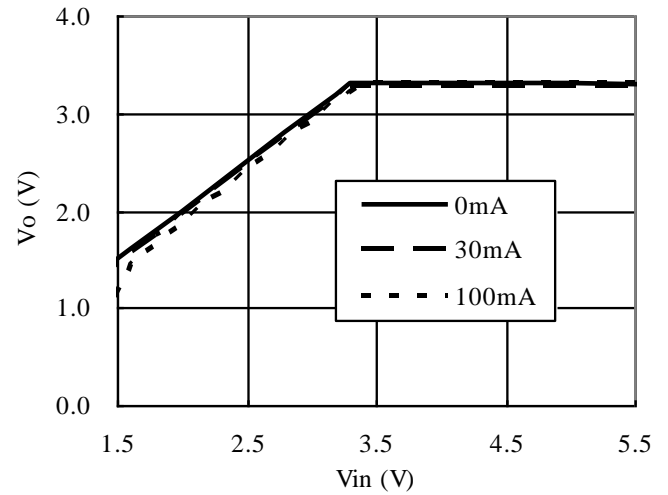
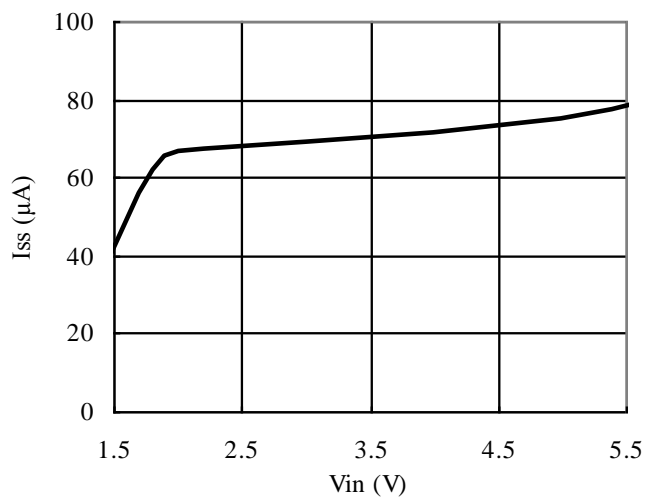
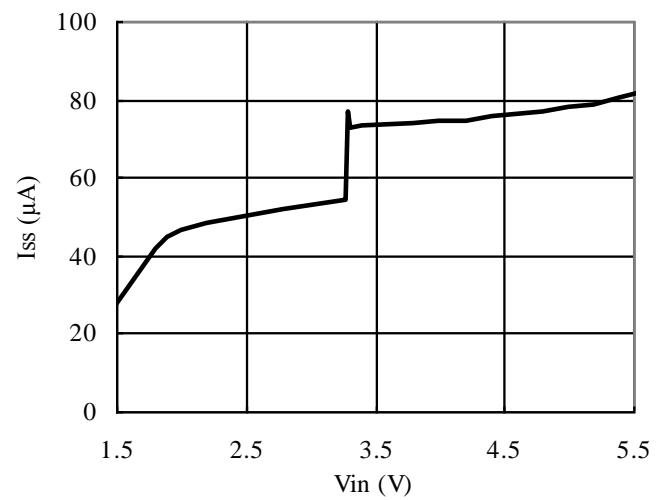
2. Output Voltage vs. Input Voltage
PT7M8205 (1.2V)
 $T_{opr}=25^{\circ}\text{C}$
 $C_{in}=1\ \mu\text{F}(\text{Ceramics}), C_{out}=1\ \mu\text{F}(\text{Ceramics})$

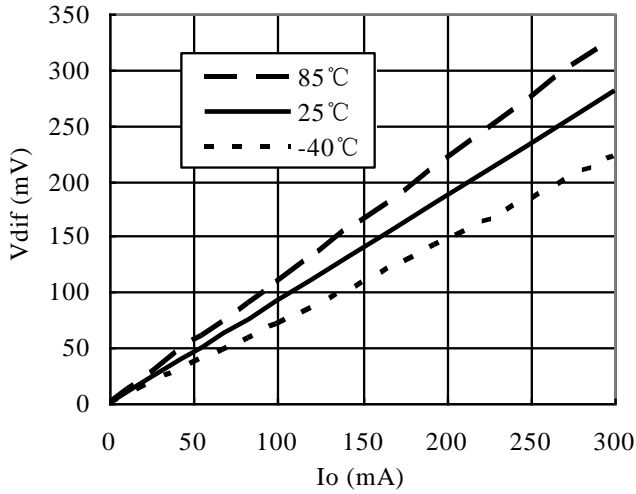
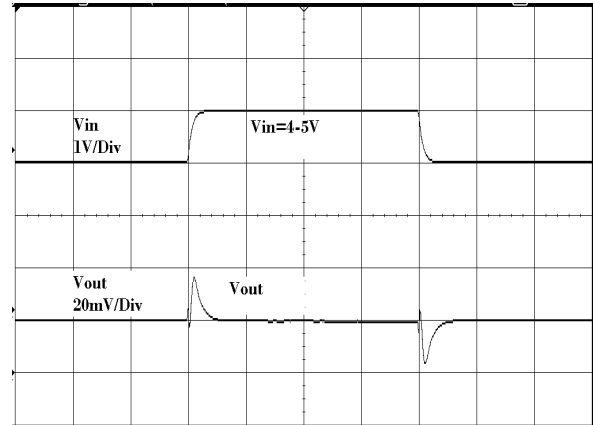
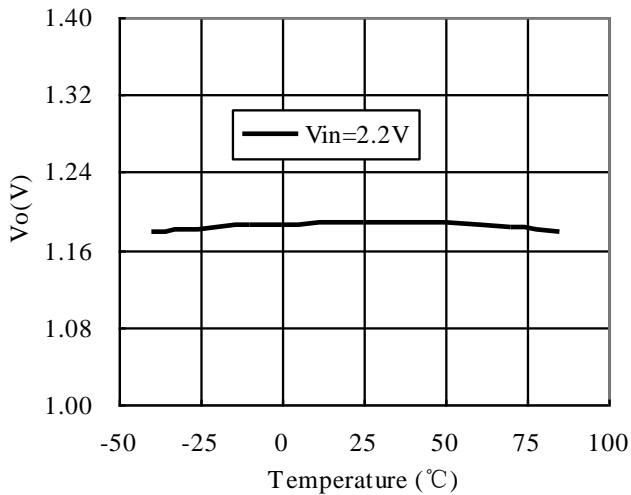
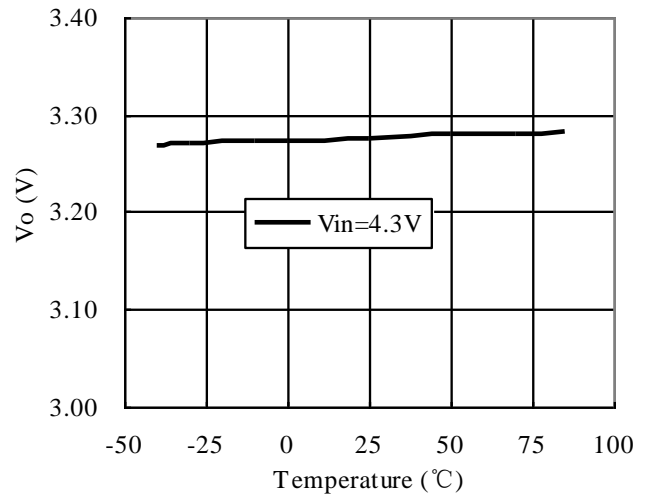
PT7M8205 (3.3V)
 $T_{opr}=25^{\circ}\text{C}$
 $C_{in}=1\ \mu\text{F}(\text{Ceramics}), C_{out}=1\ \mu\text{F}(\text{Ceramics})$

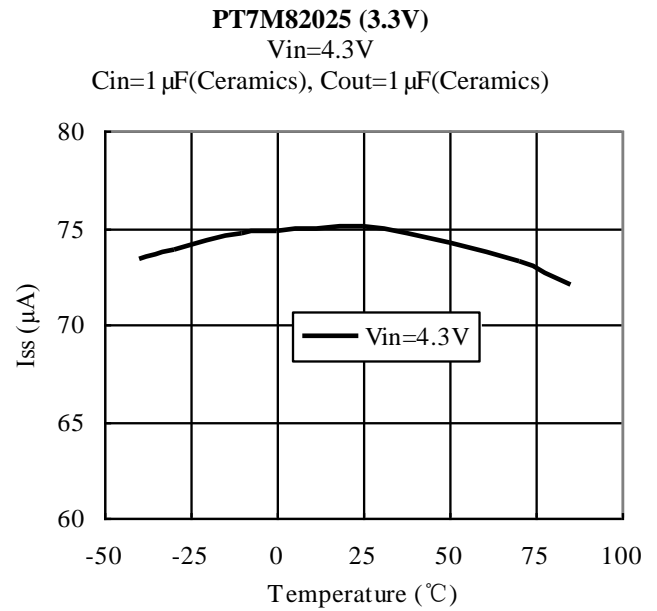
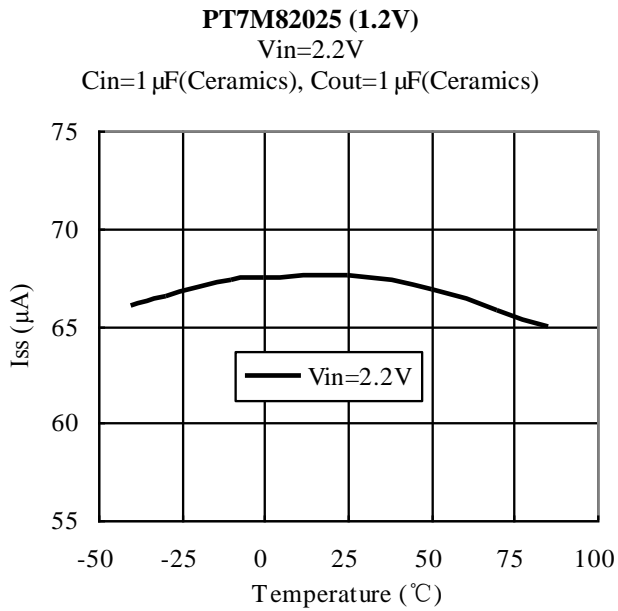
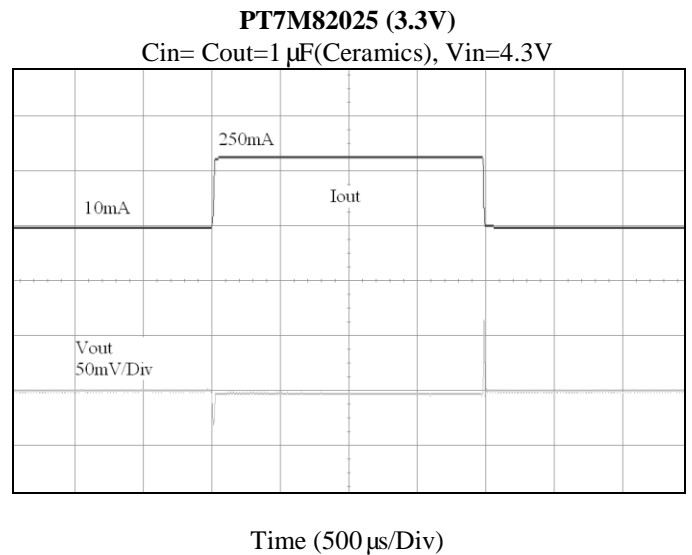
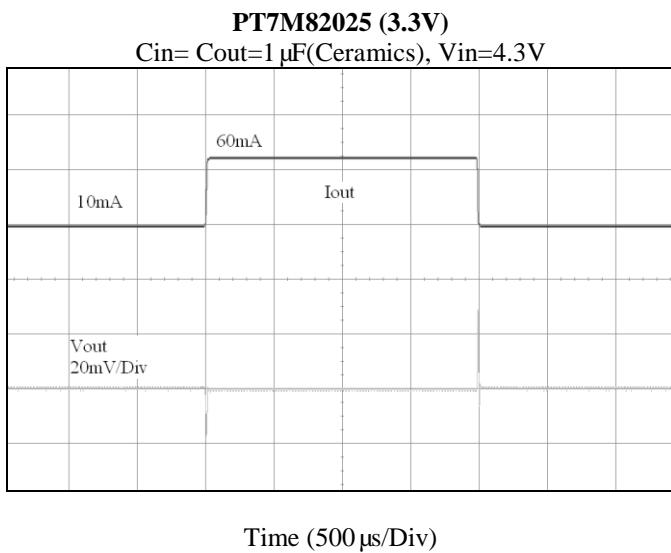
3. Supply Current vs. Input Voltage
PT7M8205 (1.2V)

PT7M8205 (3.3V)

4. Dropout Voltage vs. Output Current
PT7M82025 (3.3V)
 $C_{in}=1\ \mu\text{F}(\text{Ceramics}), C_{out}=1\ \mu\text{F}(\text{Ceramics})$

5. Input Transient Response
PT7M82025 (3.3V)
 $C_{in}=C_{out}=1\ \mu\text{F}(\text{Ceramics}), I_{out}=100\text{mA}$
 Time (50 $\mu\text{s}/\text{Div}$)

6. Output Voltage vs. Ambient Temperature
PT7M82025 (1.2V)
 $V_{in}=2.2\text{V}$
 $C_{in}=1\ \mu\text{F}(\text{Ceramics}), C_{out}=1\ \mu\text{F}(\text{Ceramics})$

PT7M82025 (3.3V)
 $V_{in}=4.3\text{V}$
 $C_{in}=1\ \mu\text{F}(\text{Ceramics}), C_{out}=1\ \mu\text{F}(\text{Ceramics})$

7. Supply Current vs. Ambient Temperature

8. Load Transient Response

9. PSRR Curve

PT7M8205 (1.2V)

V_{in}=2.2V DC+1V_{p-p}AC

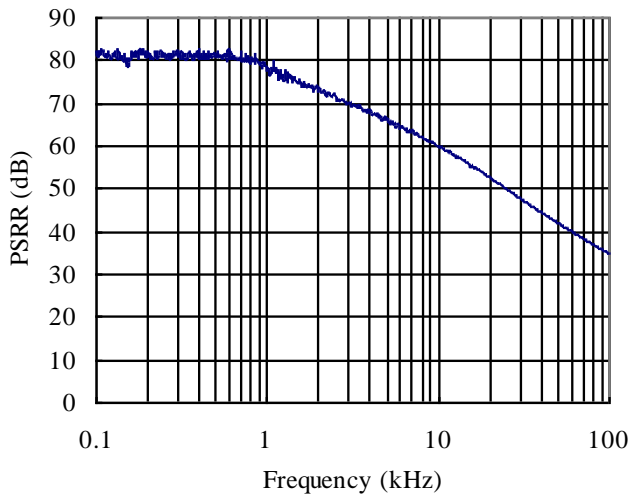
C_{in}=C_{out}=1 μF(Ceramics), I_{out}=30mA



Function block diagram

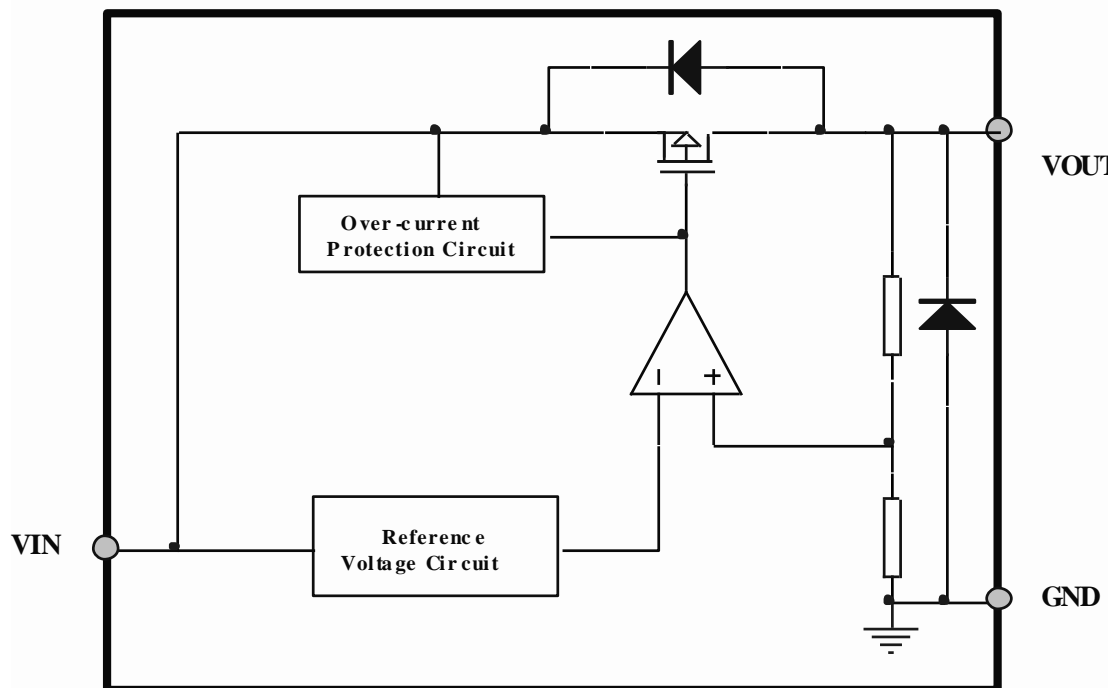

Functional Description *(Refer to Function Block Diagram)*

Output Voltage

The divided output voltage is compared with the internal reference voltage by the error amplifier with internal phase compensator. The output of the error amplifier then drives the P-channel MOSFET to maintain a stable and constant output voltage.

Low ESR Capacitors

The internal phase compensator maintains the stable output voltage with low ESR ceramic input and output capacitors. 1 μ F low ESR (X5R/X7R) ceramic capacitor located as close as possible to the IC's pins is recommended.

Current Limit and Thermal Shutdown Protections

Current limit protection is used to limit the output current when an overload condition occurs. As a result, the output voltage will drop. Thermal shutdown protection will turn off the output to reduce the power dissipation when the operation junction temperature exceeds 170 $^{\circ}$ C.

NOTE ON USE

1. Please use this IC within the stated absolute maximum ratings.
2. Where wiring impedance is high, operations may become unstable due to noise and/or phase lag depending on output current. Please keep the resistance low between VIN and GND wiring in particular.
3. Please wire the input capacitor (C_{in}) and the output capacitor (C_{out}) as close to the IC as possible.

Mechanical Information

TA (SOT23-3L)

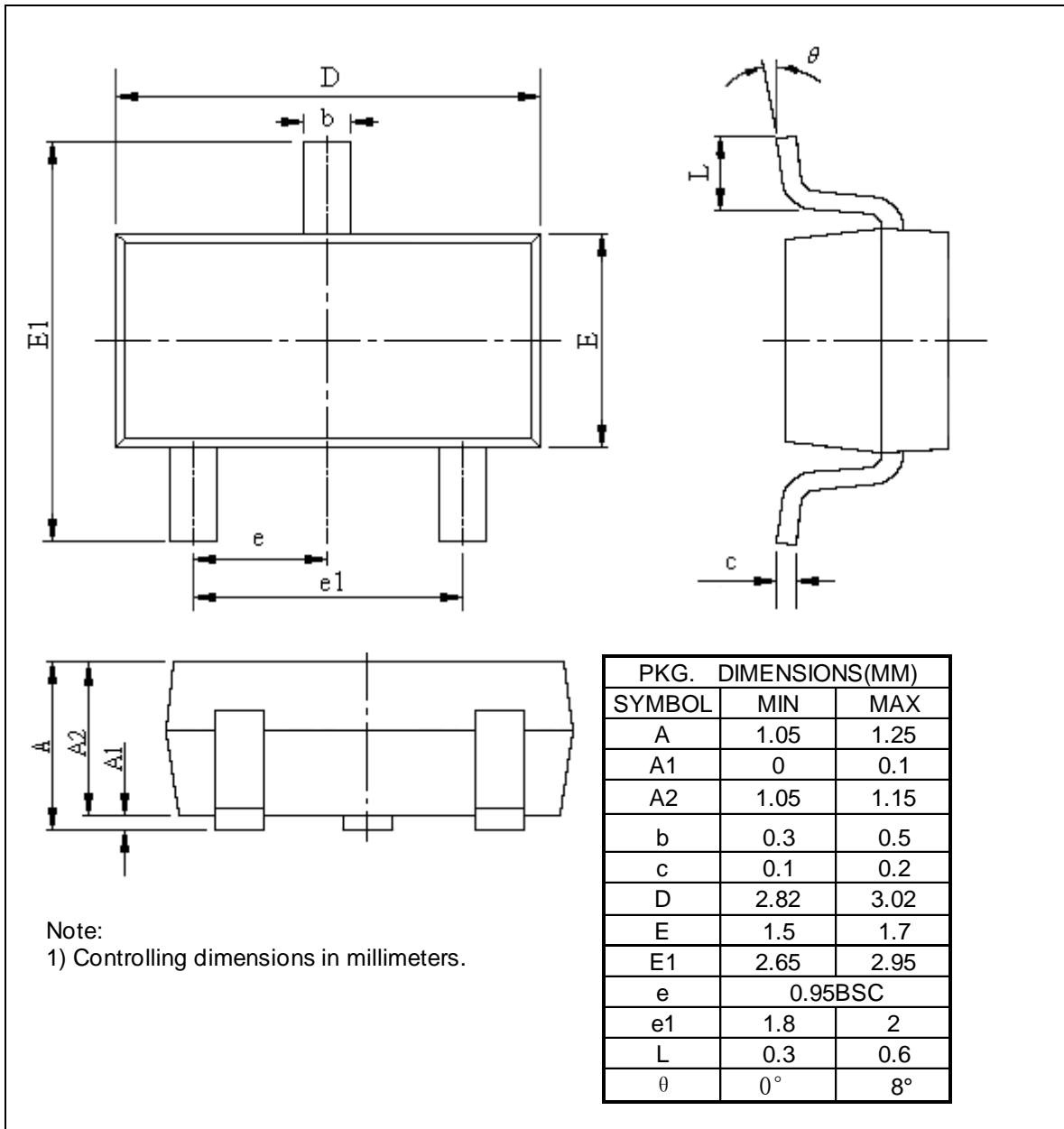

Ordering Information

Part Number	Package Code	Package
PT7M8205①②TAE	TA	Lead free and Green SOT23-3L

Notes:

- “①②” refer to different functions. See below Table 1 and Table 2.
- E = Pb-free and Green
- Adding X Suffix= Tape/Reel
- Contact Pericom for availability

Table 1 Option Definition Table

Designator	Symbol	Description
①② Regulator Output Voltage	12-33, 2A	Internally set sequential number relating output voltage of regulator , the detail is in Table 2

Table 2 Definition of designator

Designator ①②	VOUT (V)	Designator ①②	VOUT (V)	Designator ①②	VOUT (V)
12	1.2	20	2.0	28	2.8
13	1.3	21	2.1	29	2.9
14	1.4	22	2.2	30	3.0
15	1.5	23	2.3	31	3.1
16	1.6	24	2.4	32	3.2
17	1.7	25	2.5	33	3.3
18	1.8	26	2.6	2A	2.85
19	1.9	27	2.7		

Pericom Semiconductor Corporation • 1-800-435-2336 • www.pericom.com

Pericom reserves the right to make changes to its products or specifications at any time, without notice, in order to improve design or performance and to supply the best possible product. Pericom does not assume any responsibility for use of any circuitry described other than the circuitry embodied in Pericom product. The company makes no representations that circuitry described herein is free from patent infringement or other rights, of Pericom.