

Description

The PAM2846 is a high-efficiency boost type LED driver. It is designed for large LCD panel that employs an array of LEDs as back light source.

The PAM2846 employs a current-mode step-up converter that drives six parallel strings of LEDs connected in multiple series. This built-in string current-control circuit achieves $\pm 1\%$ typical current matching between strings, which ensures even brightness for all LEDs. The device is able to adapt to different numbers of LEDs in each string or different forward voltage for different types of LEDs and keep the string current constant.

Separate feedback loops limit the output voltage if one or more LEDs open or short. The limit voltage of over voltage protection is adjustable by changing the feedback resistor ratio. The PAM2846 has features cycle-by-cycle current limit to provide consistent operation and soft-start capability. A thermal-shutdown circuit provides another level of protection.

The PAM2846 has a wide +4.8V to +28V input voltage range and provides adjustable full-scale LED current. The switching frequency of this device can be selected among 500kHz, 1MHz and 1.6 MHz according to the application requirements.

Features

- Six Constant-Current Output Channels
- Parallel Channels Allow Higher Current per LED String
- Maximum 40V Continuous Voltage Output Limit for Each Channel
- Self-adaptive V_{OUT} to Fit Different LED Number
- Adjustable Constant LED Current
- Drives 10 or more LEDs Each String as Long as the String Voltage Less Than 40V
- Internal 2.5A Power MOSFET
- Low 400mV Feedback Voltage at Full Current Improves Efficiency
- Allows Digital PWM and Analog Dimming
- Wide (100:1) PWM Dimming Range without Color Shift
- Independent Dimming and Shutdown Control of the LED Driver
- Open LED Protection: Adjustable Clamp Voltage
- Short LED Protection
- 3 Frequencies Selection: 1.6MHz/1MHz/500kHz
- Wide Input Voltage Range: 4.8V to 28V
- Over Temperature Protection
- Available in 24-pin 4mmx4mm QFN Package
- Pb-free Package

Pin Assignments

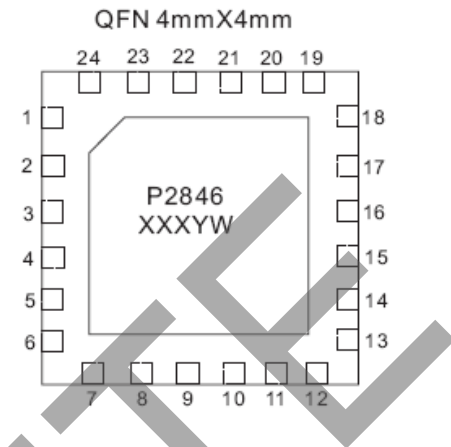

Applications

- White or RGB Backlighting for LCD TV, LCD Monitor, Notebook, Handy Terminals, and Avionics Displays Panels
- LED Lighting Devices

Typical Applications Circuit

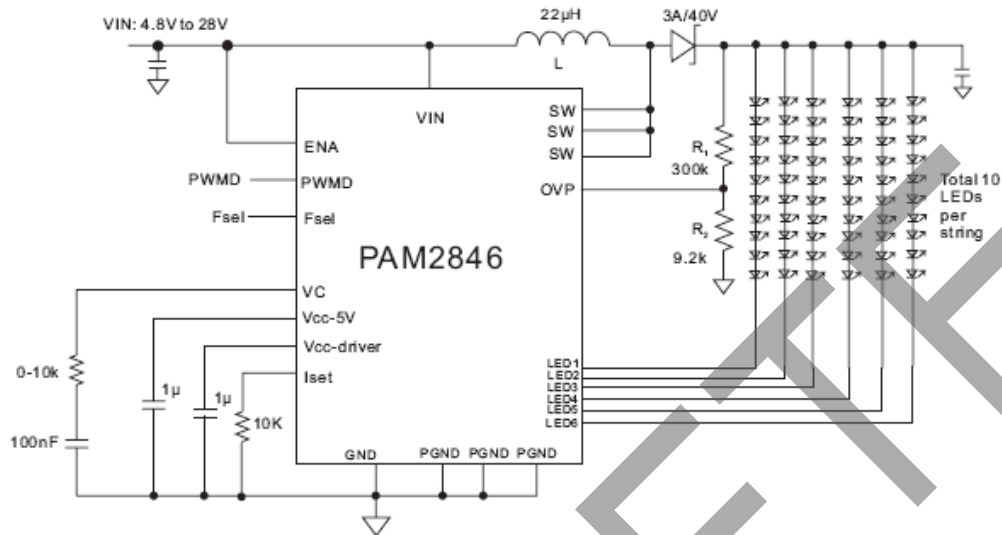

Pin Descriptions

Pin Number	Pin Name QFN4x4-24	Function
1	VIN	Supply Input
2	V _{CC-Driver}	5V Linear Regulator Output for Power MOS Driver
3	GND	Ground
4	ENA	Enable Input
5	PWMD	PWM Dimming Control
6	LED1	LED1 Cathode Terminal
7	LED2	LED2 Cathode Terminal
8	LED3	LED3 Cathode Terminal
9	GND	Ground
10	GND	Ground
11	LED4	LED4 Cathode Terminal
12	LED5	LED5 Cathode Terminal
13	LED6	LED6 Cathode Terminal
14	I _{SET}	LED Current Adjustment Pin
15	V _{CC-5V}	5V Linear Regulator
16	VC	Boost Stage Compensation Pin
17	F _{SEL}	Oscillator Frequency Selection Pin
18	FB	Feedback
19	PGND	Power Ground
20	PGND	Power Ground
21	PGND	Power Ground
22	SW	Power MOS Drain
23	SW	Power MOS Drain
24	SW	Power MOS Drain

OBSOLETE - PART DISCONTINUED

OBSOLETE - PART DISCONTINUED

Functional Block Diagram

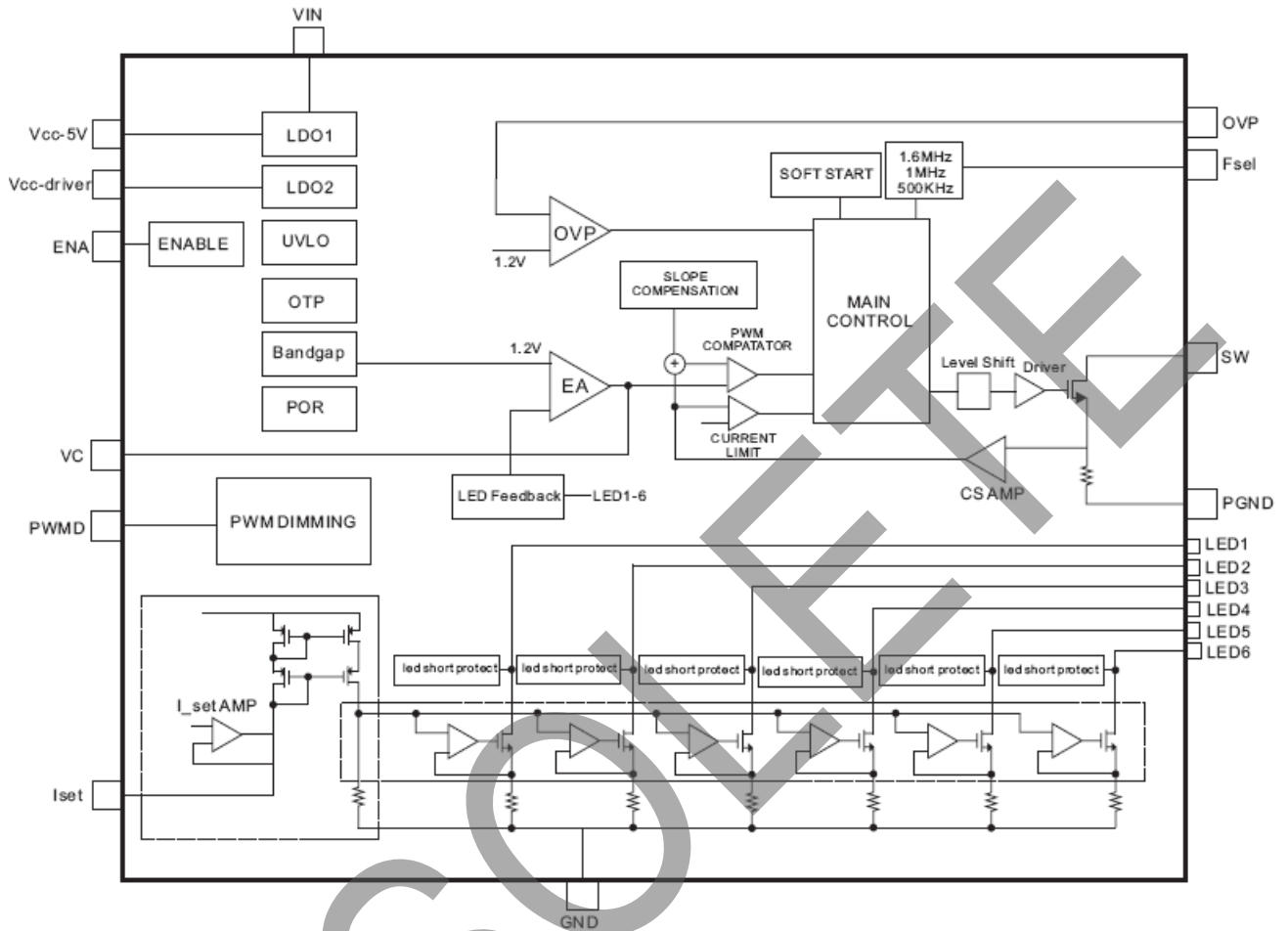

Absolute Maximum Ratings (@ $T_A = +25^{\circ}\text{C}$, unless otherwise specified.)

These are stress ratings only and functional operation is not implied. Exposure to absolute maximum ratings for prolonged time periods may affect device reliability. All voltages are with respect to ground.

Parameter	Rating	Unit
VIN, ENA	-0.3 to +30	V
SW, LED	-0.3 to +40	
V _{CC} -5V, V _{CC} -Driver, VC	-0.3 to +6.0	
PWMD, F _{SEL} , OVP, I _{SET}	-0.3 to +6.0	
Storage Temperature	-65 to +170	°C
Maximum Junction Temperature	+170	
Soldering Temperature	300, 5sec	

Recommended Operating Conditions (@T_A = +25°C, unless otherwise specified.)

Parameter	Rating	Unit
Supply Voltage Range	4.8 to 28V	V
Junction Temperature Range	-40 to +150	°C
Ambient Temperature Range	-40 to +85	

Thermal Information

Parameter	Package	Symbol	Max	Unit
Thermal Resistance (Junction to Case)	QFN4x4-24	θ _{JC}	12	°C/W
Thermal Resistance (Junction to Environment)	QFN4x4-24	θ _{JA}	30	

Electrical Characteristics

(@T_A = +25°C, V_{IN} = ENA = 12V, R_{SET} = 10kΩ, L = 22μH, unless otherwise specified.)

Parameter	Test Conditions	Min	Typ	Max	Unit
Input Voltage Range		4.8	-	28	V
Quiescent Current	ENA = High (No Switching Frequency)	-	1	2	mA
	F _{SEL} = High (1.6M Switching Frequency)	-	10	-	
	F _{SEL} = High (1M Switching Frequency)	-	6	-	
	F _{SEL} = High (500k Switching Frequency)	-	3	-	
		ENA = Low	-	5	20
LDO Stage					
VDD_5V	No switching	4.7	5.0	5.5	V
VDD_5V Current Limit	No switching	14	74	90	mA
VDD_5V UVLO Threshold	No switching	3.9	4.2	4.5	V
VDD_5V UVLO Hysteresis	No switching	-	70	-	mV
VDD_Driver	No switching	4.7	5.0	5.5	V
VDD_Driver Current Limit	No switching	14	74	90	mA
VDD_Driver UVLO Threshold	No switching	3.9	4.2	4.5	V
VDD_Driver UVLO Hysteresis	No switching	-	70	-	mV
Boost Stage					
Switch RDS(ON)	V _{CC_5V} = 5V	-	0.2	-	Ω
Switch Current Limit		-	2.5	-	A
Switch Leakage Current		-	1	-	μA
Switching Frequency	F _{SEL} = V _{CC_5V}	-	1.6	-	MHz
	F _{SEL} = Open	-	1.0	-	MHz
	F _{SEL} = GND	-	500	-	kHz
Minimum Duty Cycle	F _{SEL} = V _{CC_5V}	-	20	-	%
	F _{SEL} = Open	-	10	-	%
	F _{SEL} = GND	-	5	-	%
Maximum Duty Cycle		-	90	-	%
VC Source Current		-	60	-	μA
VC Sink Current		-	60	-	μA

Electrical Characteristics (Cont.)

(@T_A = +25°C, V_{IN} = ENA = 12V, R_{SET} = 10kΩ, L = 22μH, unless otherwise specified.)

Parameter	Test Conditions	Min	Typ	Max	Unit
LED Controller Stage					
Full-Scale LED_Output Current	I = 190*1.2V/R _{SET} , R _{SET} = 7.68k	-	30	-	mA
	I = 190*1.2V/R _{SET} , R _{SET} = 11.3k	-	20	-	mA
	I = 190*1.2V/R _{SET} , R _{SET} = 22.6k	-	10	-	mA
LED Current Matching	-	-3	1	+3	%
ISET Voltage	-	-	1.2	-	V
Minimums LED Voltage	-	-	400	-	mV
Analog Dimming Range	I = 190*1.2V/R _{SET}	1/32	-	1	mA
PWM Dimming Frequency	-	100	-	1k	Hz
Fault Protection					
LED_Overshoot Threshold	-	4.6	4.9	5.1	V
LED_Overshoot Hysteresis	-	-	1	-	V
Overshoot Threshold	-	-	1.2	-	V
Overshoot Hysteresis	-	-	80	-	mV
Thermal-Shutdown	-	-	+150	-	°C
Thermal-Shutdown Hysteresis	-	-	+30	-	°C
Control Interface					
EN High	-	1.5	-	-	V
EN Low	-	-	-	0.4	V
PWMD High	-	1.5	-	-	V
PWMD Low	-	-	-	0.4	V
FSEL High	-	V _{CC_5V} -0.5	-	-	V
FSEL Midlevel	-	1	-	2	V
FSEL Low	-	-	-	0.5	V
EN Min Pulse Width	Single Wire Dimming Low Level	0.5	-	-	μs
EN Max Pulse Width	Single Wire Dimming Low Level	-	-	10	μs
EN Off Delay	Single Wire Dimming Low Level	-	200	-	μs

OBSOLETE - PART DISCONTINUED

OBSOLETE

OBSOLETE - PART DISCONTINUED

Typical Performance Characteristics

(@T_A = +25°C, V_{IN} = ENA = 12V, R_{SET} = 10kΩ, L = 22μH, F_{SW} = 500kHz, 10x6 LEDs, unless otherwise specified.)

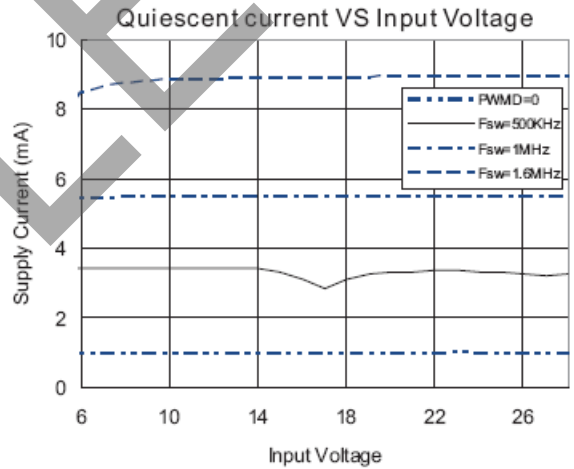
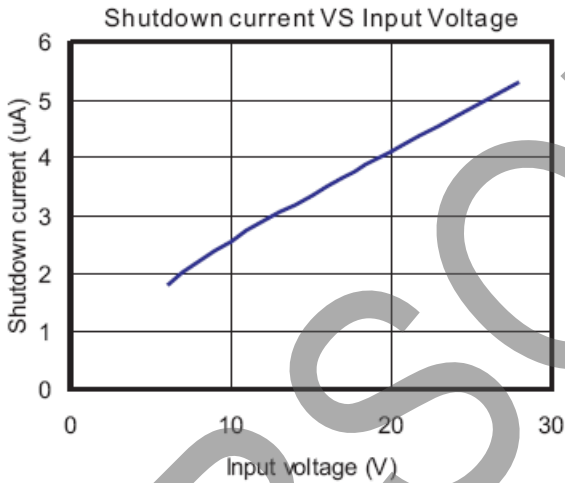
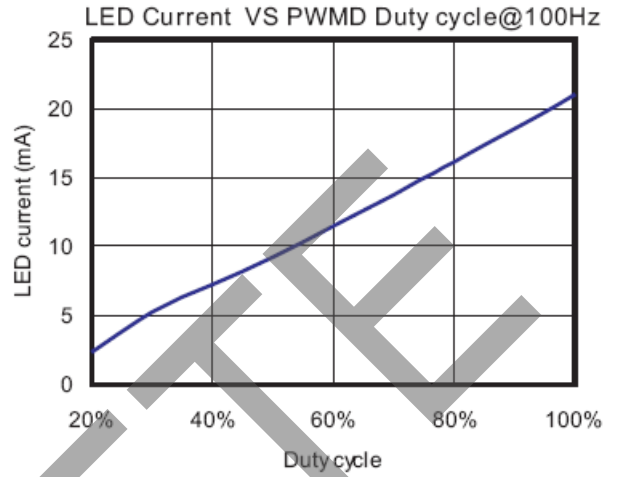
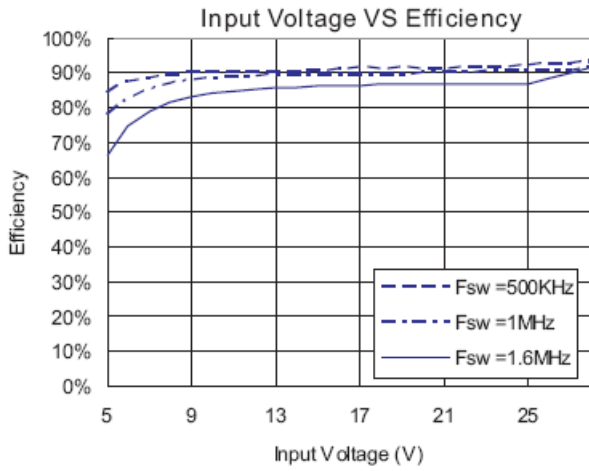

OBSOLETE - PART DISCONTINUED

Typical Performance Characteristics (Cont.)

(@T_A = +25°C, V_{IN} = ENA = 12V, R_{SET} = 10kΩ, L = 22μH, F_{SW} = 500kHz, 10x6 LEDs, unless otherwise specified.)

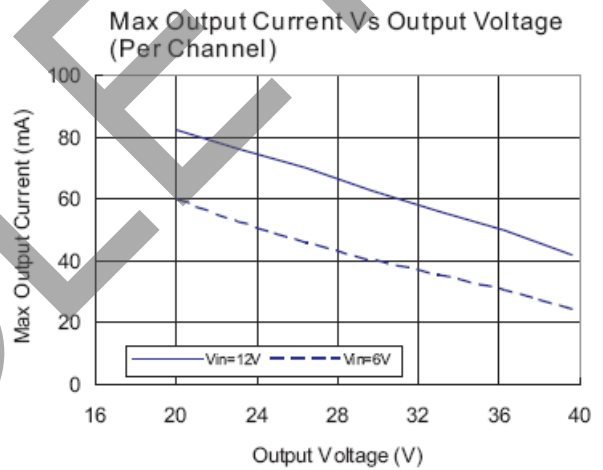
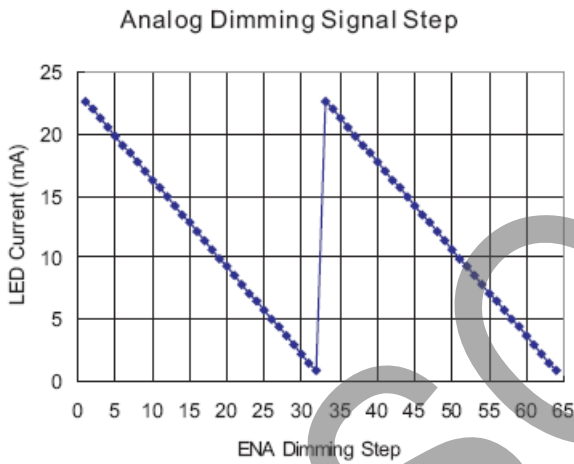
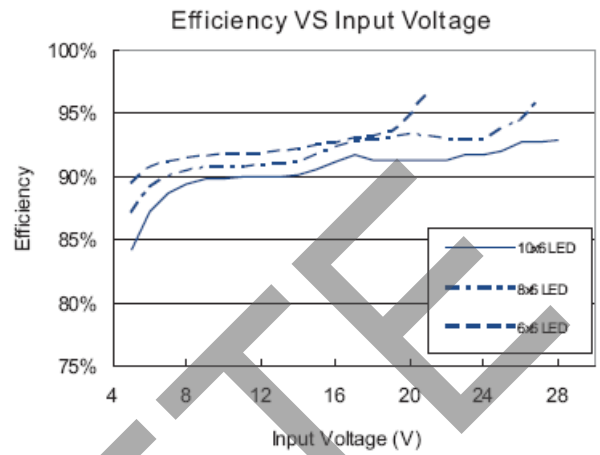
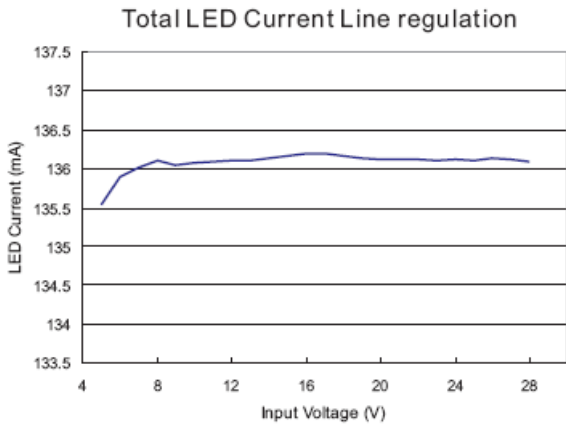

OBSOLETE

OBSOLETE - PART DISCONTINUED

Typical Performance Characteristics (Cont.)

(@T_A = +25°C, V_{IN} = ENA = 12V, R_{SET} = 10kΩ, L = 22μH, F_{SW} = 500kHz, 10x6 LEDs, unless otherwise specified.)

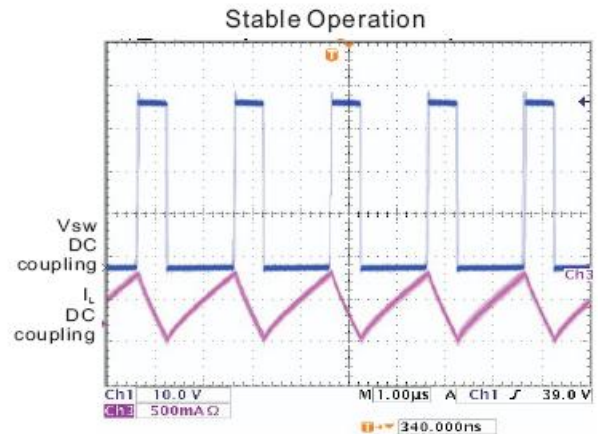
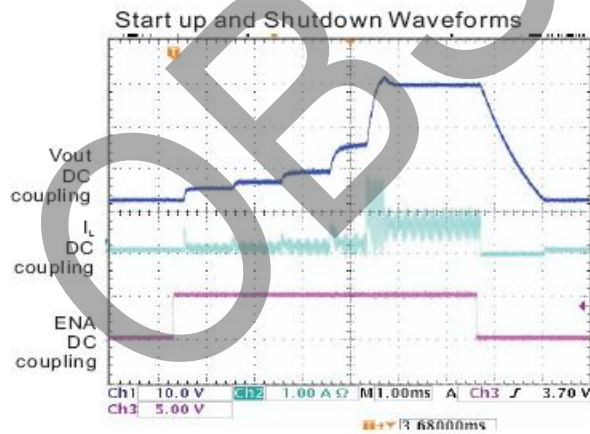
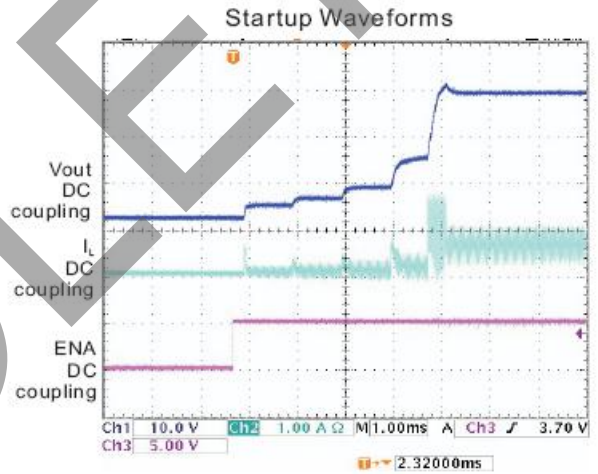
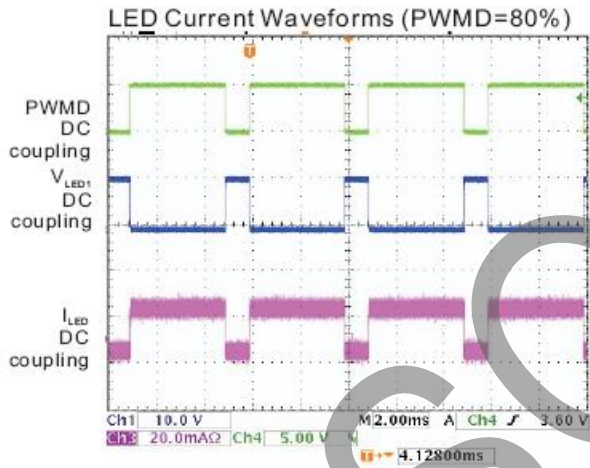
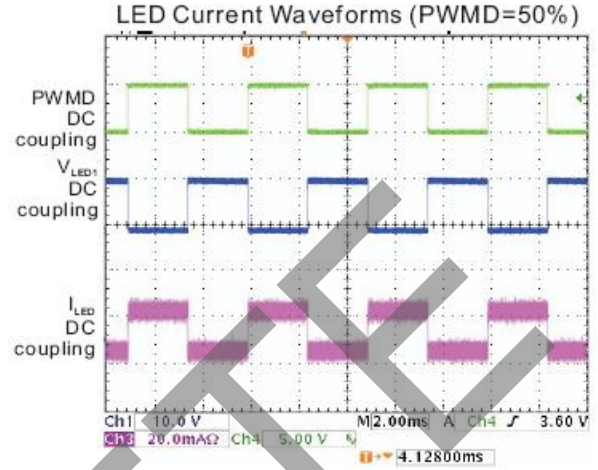
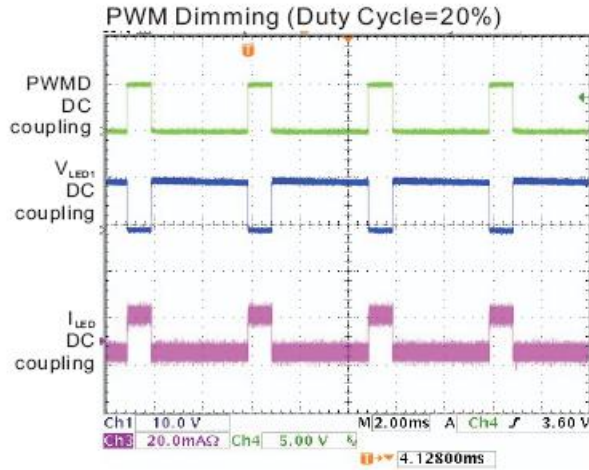

Application Information

The inductance, peak current rating, series resistance, and physical size should all be considered when selecting an inductor. These factors affect the converter's operating mode, efficiency, maximum output load capability, transient response time, output voltage ripple, and cost.

The maximum output current, input voltage, output voltage, and switching frequency determine the inductor value. Very high inductance minimizes the current ripple, and therefore reduces the peak current, which decreases core losses in the inductor and I^2R losses in the entire power path. However, large inductor values also require more energy storage and more turns of wire, which increases physical size and I^2R copper losses in the inductor. Low inductor values decrease the physical size, but increase the current ripple and peak current. Finding the best inductor involves the compromises among circuit efficiency, inductor size, and cost.

When choosing an inductor, the first step is to determine the operating mode: continuous conduction mode (CCM) or discontinuous conduction mode (DCM). When CCM mode is chosen, the ripple current and the peak current of the inductor can be minimized. If a small-size inductor is required, DCM mode can be chosen. In DCM mode, the inductor value and size can be minimized but the inductor ripple current and peak current are higher than those in CCM.

Capacitor Selection

An input capacitor is required to reduce the input ripple and noise for proper operation of the PAM2846. For good input decoupling, low ESR (equivalent series resistance) capacitors should be used at the input. At least $2.2\mu\text{F}$ input capacitor is recommended for most applications. A minimum output capacitor value of $10\mu\text{F}$ is recommended under normal operating conditions, while a $22\mu\text{F}$ or higher capacitor may be required for higher power LED current. A reasonable value of the output capacitor depends on the LED current. The total output voltage ripple has two components: the capacitive ripple caused by the charging and discharging on the output capacitor, and the ohmic ripple due to the capacitor's equivalent series resistance. The ESR of the output capacitor is the important parameter to determine the output voltage ripple of the converter, so low ESR capacitors should be used at the output to reduce the output voltage ripple. The voltage rating and temperature characteristics of the output capacitor must also be considered. So a value of $10\mu\text{F}$, voltage rating (50V) capacitor is chosen.

Diodes Selection

PAM2846 is high switching frequency converter, which demands high speed rectifier. It's indispensable to use a Schottky diode rated at 2A, 60V with the PAM2846. Using a Schottky diode with a lower forward voltage drop can improve efficiency of the converter. The voltage rating of the diode should be greater than the output voltage.

Methods for Setting LED Current

There are three methods for setting and adjusting the LED current outlined here. The methods are:

- 1) RSET only
- 2) PWM Input at PWMD
- 3) Single wire logic signal at ENA

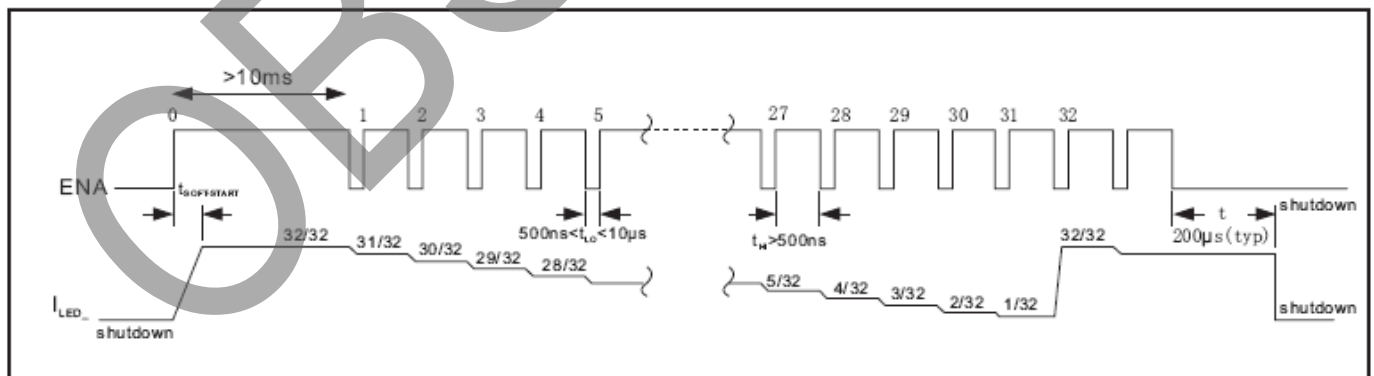

Figure 1. Timing Diagram for EN

Application Information (Cont.)

- **Method 1: LED Current Setting with External Resistor R_{ISET}**

The most basic means of setting the LED current is connecting a resistor between R_{ISET} and GND. The LED current is decided by I_{SET} Resistor.

$$I_{LED} = 228 / R_{ISET}$$

- **Method 2: LED Current Setting with PWM Signal to PWM Signal to PWMD Pin**

This circuit uses resistor R_{ISET} to set the on state current and the average LED current, then proportional to the percentage of on-time when the PWMD pin is logic low. Average LED current is approximately equal to:

$$I = (t_{ON} * I) / (t_{ON} + t_{OFF})$$

Also, the recommended PWM frequency is between 100Hz and 1kHz. Frequency <100Hz can cause the LEDs to blink visibly.

- **Method 3: LED Current Setting with Single Wire Logic to ENA Pin**

When the LEDs are enabled by high level, the LED current initially goes to I_{LED} . Dimming is done by pulsing ENA low (500ns to 10 s pulse width). Each pulse reduces the LED current by 1/32, so after one pulse the LED current is $31/32 * I_{LED}$. The 32th pulse sets the LED current back to I_{LED} . Figure 1 shows a timing diagram for EN.

Setting the Over Voltage Protection

The OVP pin is connected to the center tap of a resistive voltage divider (R_1 and R_2 in Typical Application diagram) from the high-voltage output.

$$V_{OUT_LIMIT} = V_{OV} (1 + R_2/R_1)$$

The recommend procedure is to choose $R_2 = 300k\Omega$ and $R_1 = 9.2k\Omega$ to set $V_{OUT_LIMIT} = 40V$. This OVP pin is used for over voltage protect, not for output voltage regulate.

LED Short Protection

The PAM2846 uses LED_OVP function to protect devices when one or more LED(s) is/are shorted.

$$V_{LED} = V_{OUT} - V_f * N$$

Normally V_{LED} is around 0.4V and V_{OUT} is decided by LED numbers. When one or more LED(s) is/are shorted, the PAM2846 will clamp V_{OUT} to make sure all LED pins' voltage is less than 5V. With this function V_{OUT} will be clamped at $(5V + V_f * N_{MIN})$.

Note:

- V_{LED} : LED pin voltage
- V_{OUT} : Output voltage
- V_f : LED forward voltage
- N_{MIN} : The minimum LED numbers among all strings.

LED Open Protection

The control loop is related to all six LED sinks. When one or more LED(s) is/are opened, the sink will have no current and the device will work in unstable open loop state. The V_{OUT} voltage will be limited by external resistor divider or $5V + V_f * N_{MIN}$, whichever is lower.

Application Information (Cont.)

PCB Layout Guidelines

Careful PCB layout is important for proper operation. Use the following guidelines for good PCB layout:

- 1) Minimize the area of the high current switching loop of the rectifier diode and output capacitor to avoid excessive switching noise.
- 2) Connect high-current input and output components with short and wide connections. The high-current input loop goes from the positive terminal of the input capacitor to the inductor, to the SW pin. The high-current output loop is from the positive terminal of the input capacitor through the inductor, rectifier diode, and positive terminal of the output capacitors, reconnecting between the output capacitor and input capacitor ground terminals. Avoid using vias in the high-current paths. If vias are unavoidable, use multiple vias in parallel to reduce resistance and inductance.
- 3) Create a ground island (PGND) consisting of the input and output capacitor ground and PGND pin. Connect all these together with short, wide traces or a small ground plane. Maximizing the width of the power ground traces improves efficiency and reduces output-voltage ripple and noise spikes. Create an analog ground island (GND) consisting of the output voltage detection-divider ground connection, the I resistor connections, VCC-5V and VCC-driver capacitor connections, and the device's exposed backside pad. Connect the GND and PGND islands by connecting the GND pins directly to the exposed backside pad. Make sure no other connections between these separate ground planes.
- 4) Place the output voltage setting-divider resistors as close to the OVP pin as possible. The divider's center trace should be kept short. Avoid running the sensing traces near SW Pin.
- 5) Place the VIN pin bypass capacitor as close to the device as possible. The ground connection of the VIN bypass capacitor should be connected directly to GND pins with a wide trace.
- 6) Minimize the size of the SW node while keeping it wide and short. Keep the SW node away from the feedback node and ground. If possible, avoid running the SW node from one side of the PCB to the other.
- 7) Refer to the PAM2845 Evaluation board for an example of proper board layout.

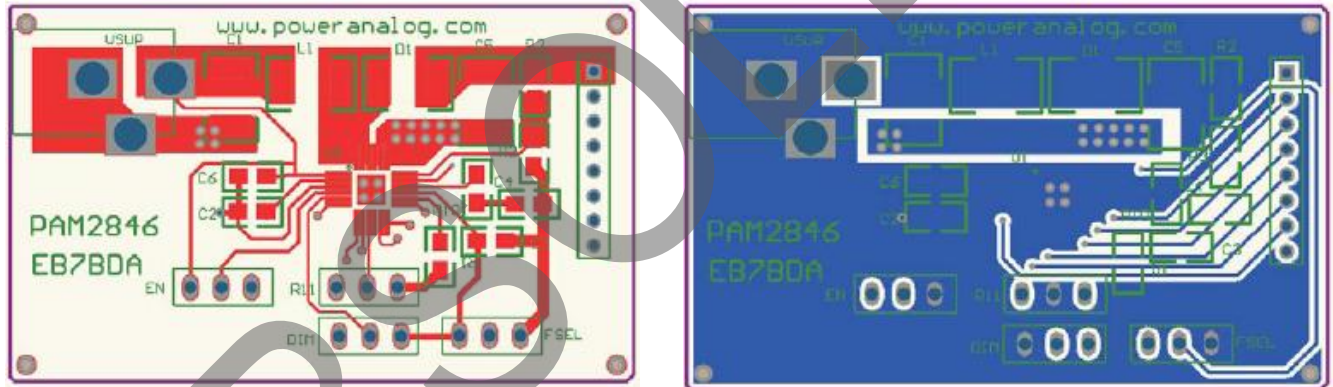

PAM2846 Evaluation Board

OBSOLETE - PART DISCONTINUED

Ordering Information

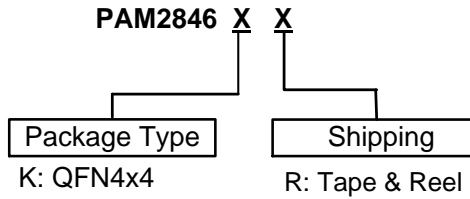

Part Number	Marking	Package Type	Standard Package
PAM2846KR	P2846 XXXYW	QFN4x4	3000 Units/ Tape & Reel

Marking Information

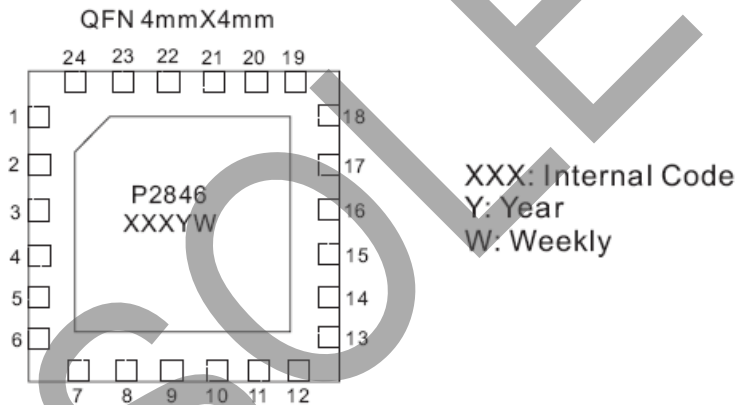

OBSOLETE

Package Outline Dimensions (All dimensions in mm.)

QFN4x4-24

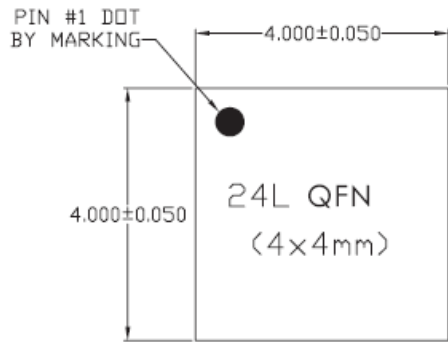

TOP VIEW

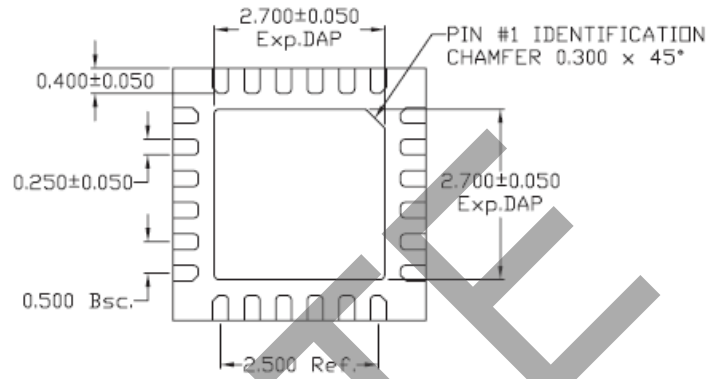

BOTTOM VIEW



SIDE VIEW

A	MAX.	0.800
	NOM.	0.750
	MIN.	0.700

Note: all dimensions are in millimeters.

OBSOLETE - PART DISCONTINUED

OBSOLETE

IMPORTANT NOTICE

DIODES INCORPORATED MAKES NO WARRANTY OF ANY KIND, EXPRESS OR IMPLIED, WITH REGARDS TO THIS DOCUMENT, INCLUDING, BUT NOT LIMITED TO, THE IMPLIED WARRANTIES OF MERCHANTABILITY AND FITNESS FOR A PARTICULAR PURPOSE (AND THEIR EQUIVALENTS UNDER THE LAWS OF ANY JURISDICTION).

Diodes Incorporated and its subsidiaries reserve the right to make modifications, enhancements, improvements, corrections or other changes without further notice to this document and any product described herein. Diodes Incorporated does not assume any liability arising out of the application or use of this document or any product described herein; neither does Diodes Incorporated convey any license under its patent or trademark rights, nor the rights of others. Any Customer or user of this document or products described herein in such applications shall assume all risks of such use and will agree to hold Diodes Incorporated and all the companies whose products are represented on Diodes Incorporated website, harmless against all damages.

Diodes Incorporated does not warrant or accept any liability whatsoever in respect of any products purchased through unauthorized sales channel. Should Customers purchase or use Diodes Incorporated products for any unintended or unauthorized application, Customers shall indemnify and hold Diodes Incorporated and its representatives harmless against all claims, damages, expenses, and attorney fees arising out of, directly or indirectly, any claim of personal injury or death associated with such unintended or unauthorized application.

Products described herein may be covered by one or more United States, international or foreign patents pending. Product names and markings noted herein may also be covered by one or more United States, international or foreign trademarks.

This document is written in English but may be translated into multiple languages for reference. Only the English version of this document is the final and determinative format released by Diodes Incorporated.

LIFE SUPPORT

Diodes Incorporated products are specifically not authorized for use as critical components in life support devices or systems without the express written approval of the Chief Executive Officer of Diodes Incorporated. As used herein:

A. Life support devices or systems are devices or systems which:

1. are intended to implant into the body, or
2. support or sustain life and whose failure to perform when properly used in accordance with instructions for use provided in the labeling can be reasonably expected to result in significant injury to the user.

B. A critical component is any component in a life support device or system whose failure to perform can be reasonably expected to cause the failure of the life support device or to affect its safety or effectiveness.

Customers represent that they have all necessary expertise in the safety and regulatory ramifications of their life support devices or systems, and acknowledge and agree that they are solely responsible for all legal, regulatory and safety-related requirements concerning their products and any use of Diodes Incorporated products in such safety-critical, life support devices or systems, notwithstanding any devices- or systems-related information or support that may be provided by Diodes Incorporated. Further, Customers must fully indemnify Diodes Incorporated and its representatives against any damages arising out of the use of Diodes Incorporated products in such safety-critical, life support devices or systems.

Copyright © 2018, Diodes Incorporated

www.diodes.com