

ESD PROTECTION DIODE

**STAND-OFF VOLTAGE – 5.0 Volts
POWER DISSIPATION - 50 Watts**

GENERAL DESCRIPTION

The L05L5V0M6-4 is ultra low capacitance ESD designed to protect high speed data interfaces. This series has been specifically designed to protect sensitive components which are connected to high-speed data and transmission lines from overvoltage caused by ESD (electrostatic discharge), CDE (Cable Discharge Events), and EFT (electrical fast transients).

FEATURES

- ESD Protect for 4 high-speed I/O channels
- Low leakage current and clamping voltage
- Low capacitance: 1.1pF typical
- Low clamping voltage
- IEC 61000-4-2, level 4 (ESD), > ±15KV (air) ; > ±8KV (contact)
- Qualified to AEC-Q101 Rev_C

APPLICATION

- I/O ports and Buses of Mobile Devices
- USB2.0 Power and Data lines protection
- Notebook and PC Computers
- Monitors and Flat Panel Displays
- IEEE 1394 Firewire Ports
- Video Graphics Cards
- MIS Ports

MECHANICAL DATA

- Case material: "Green" molding compound UL flammability classification 94V-0 (No Br, Sb, Cl)
- Terminals: Lead Free Plating (Matte Tin Finish)
- Component in accordance to RoHs 2011/65/EU

SLP1616P6E

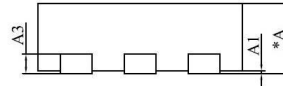

Side View

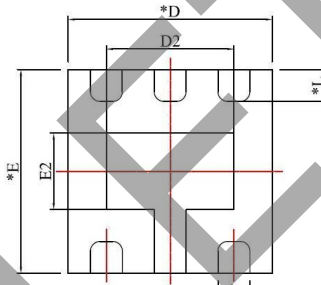

Bottom View

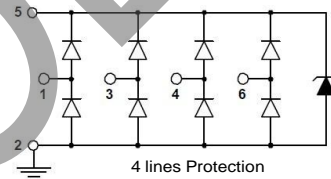

4 lines Protection

| SLP1616P6E | | | |
|------------|----------|-------|-------|
| DIM. | MIN. | MAX. | Typ. |
| *A | 0.495 | 0.555 | 0.525 |
| A1 | 0.00 | 0.05 | 0.02 |
| A3 | 0.152REF | | |
| b | 0.20 | 0.30 | 0.25 |
| *D | 1.55 | 1.65 | 1.60 |
| D2 | 0.95 | 1.05 | 1.00 |
| *E | 1.55 | 1.65 | 1.60 |
| E2 | 0.55 | 0.65 | 0.60 |
| e | 0.50BSC | | |
| *L | 0.20 | 0.30 | 0.25 |

All Dimensions in millimetre

| PIN ASSIGNMENT | |
|----------------|-----------|
| 1,3,4,6 | I/O Lines |
| 5 | Vcc |
| 2 | Ground |

MAXIMUM RATINGS AND ELECTRICAL CHARACTERISTICS

Ratings at 25°C ambient temperature unless otherwise specified.

ABSOLUTE RATINGS

| PARAMETER | SYMBOL | VALUE | UNIT |
|---|------------------|-------------|------|
| Peak pulse power (8/20us waveform) | P _{PP} | 50 | W |
| Peak pulse current (8/20us waveform) | I _{PP} | 6.5 | A |
| Operating junction temperature range | T _J | -55 to +125 | °C |
| Storage temperature range | T _{STG} | -55 to +150 | °C |
| Soldering temperature, t _{max} = 10s | T _L | 260 | °C |

ELECTRICAL CHARACTERISTICS

| PARAMETER | TEST CONDITIONS | SYMBOL | MIN. | TYP. | MAX | UNIT |
|--------------------------|--|------------------|------|------|-----|------|
| Reverse standoff voltage | Any pin to ground | V _{DRM} | -- | -- | 5 | V |
| Breakdown voltage | I _t = 1mA | V _{BR} | 6 | -- | -- | V |
| Reverse leakage current | V _{DRM} = 5V | I _{RM} | -- | -- | 5 | uA |
| Junction capacitance | V _R = 0-2.5V, f = 1MHz, Any pin to ground | C _J | -- | 1.1 | 1.6 | pF |
| Clamping voltage | I _{PP} = 5A (8/20 us) , Any pin to ground | V _C | -- | -- | 10 | V |

REV. 0, Nov.-2017, KSIR92

OBSOLETE – PART DISCONTINUED

RATING AND CHARACTERISTIC CURVES
L05L5V0M6-4



FIG.1- 8/20us pulse waveform according to IEC 61000-4-5

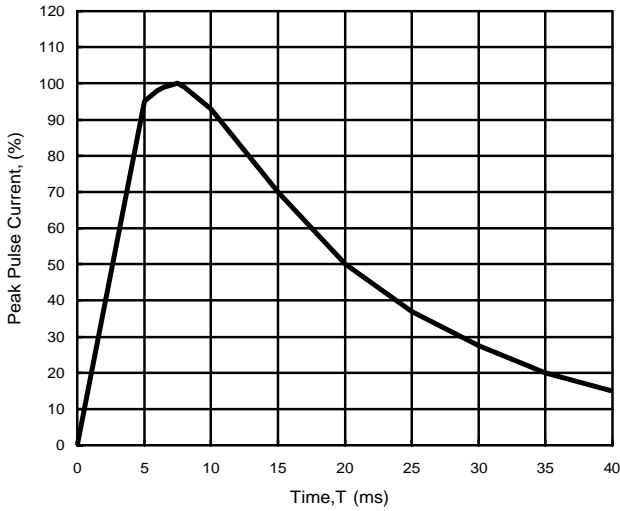

FIG .2- ESD pulse waveform according to IEC 61000-4-2

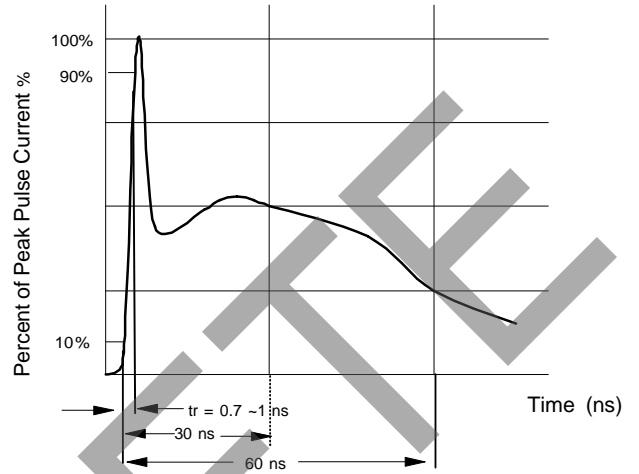

FIG.3- power dissipation versus pulse time

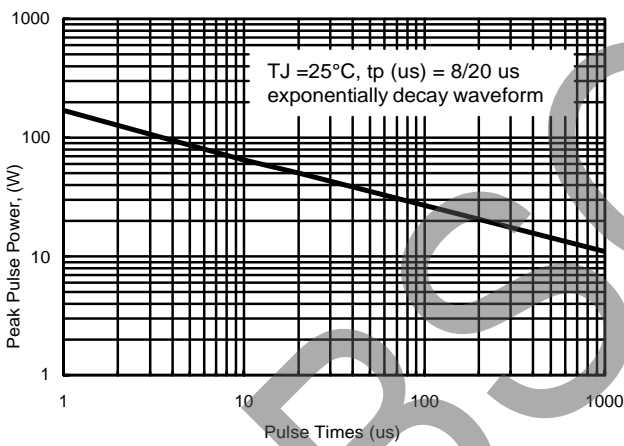

FIG.4- peak pulse power versus Tj

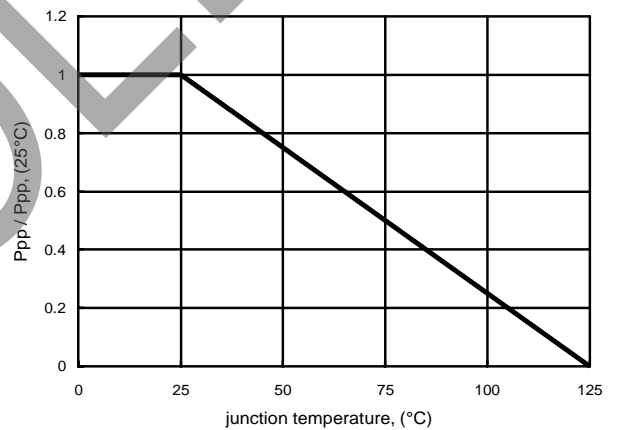

FIG.5- typical junction capacitance

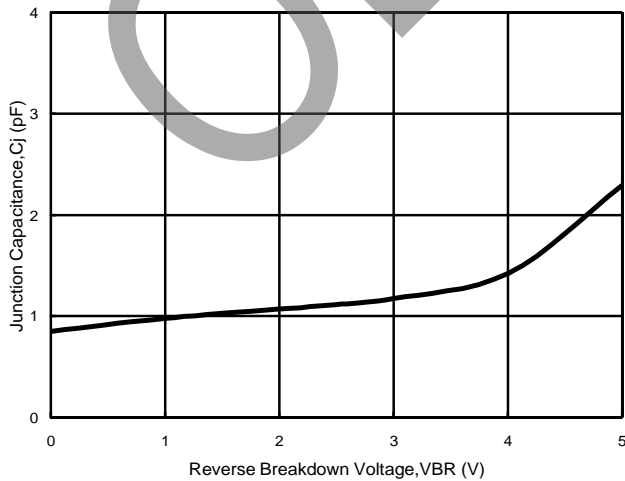
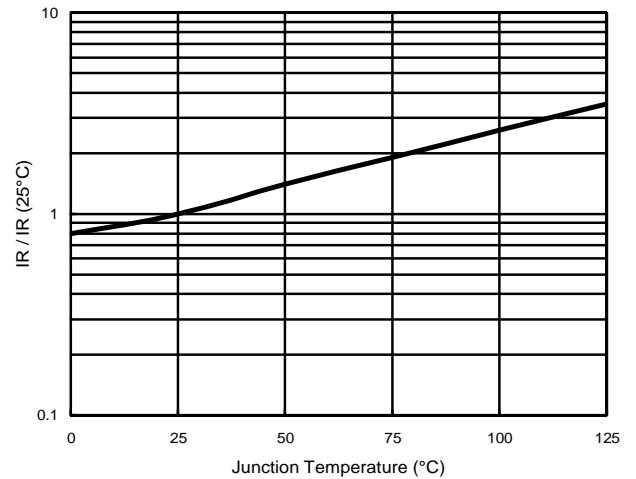

FIG.6- reverse leakage current versus Tj



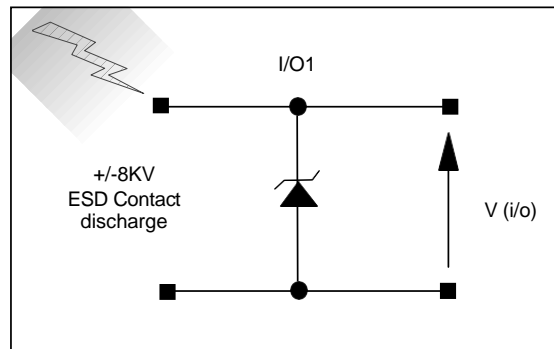

Figure 7. ESD Test Configuration

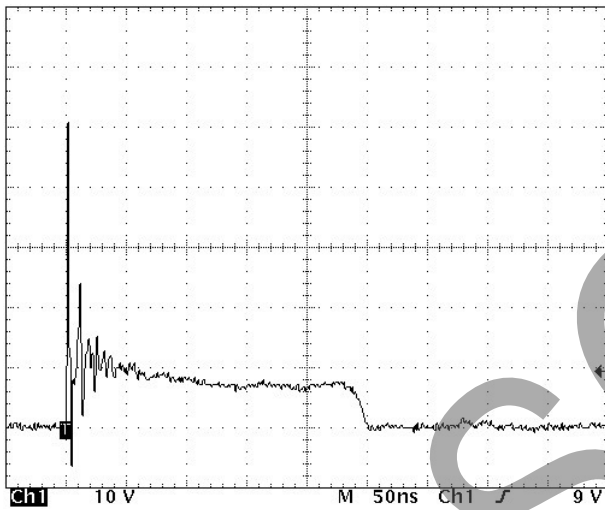

Figure 8. Clamped +8 kV ESD voltage waveform

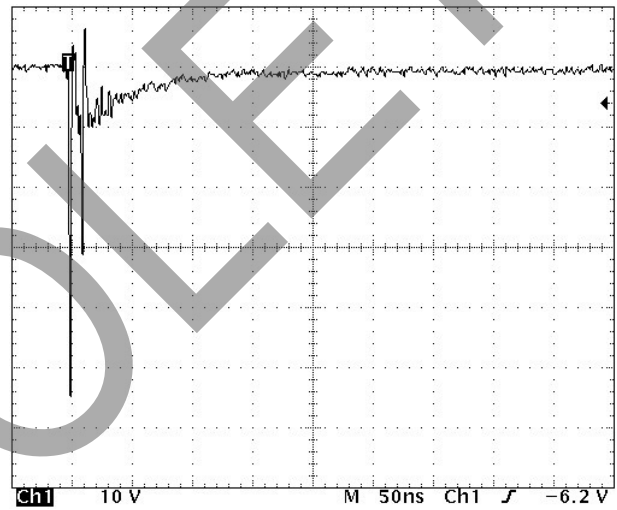
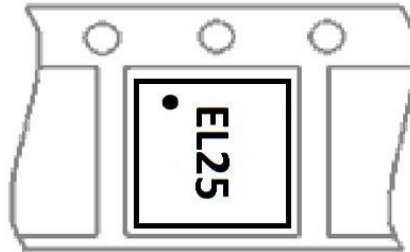

Figure 9. Clamped -8 kV ESD voltage waveform

MARKING AND PACKAGING INFORMATION L05L5V0M6-4

Marking and Orientation :



Packaging Information :

| DEVICE | Q'TY/REEL (PCS) | REEL DIA. (INCH) | Q'TY/BOX (PCS) | Q'TY/CARTON (PCS) |
|-------------|-----------------|------------------|----------------|-------------------|
| L05L5V0M6-4 | 3000 | 7 | 45K | 90K/180K |

SLP1616P6E Soldering Pad Layout :

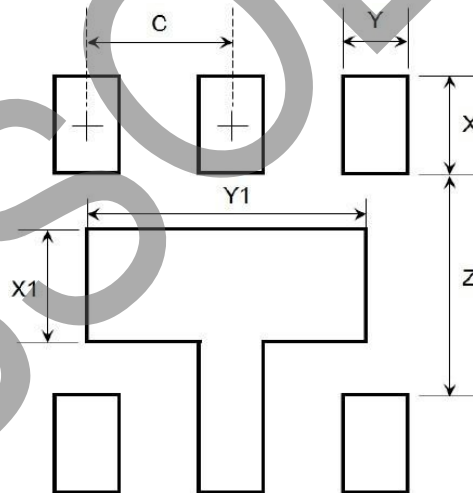

| Dim. | Millimeters | Inches |
|------|-------------|--------|
| X | 0.40 | 0.016 |
| X1 | 0.55 | 0.022 |
| Y | 0.30 | 0.012 |
| Y1 | 0.90 | 0.035 |
| C | 0.50 | 0.020 |
| Z | 1.00 | 0.039 |

Important Notice and Disclaimer

LSC reserves the right to make changes to this document and its products and specifications at any time without notice. Customers should obtain and confirm the latest product information and specifications before final design, purchase or use.

LSC makes no warranty, representation or guarantee regarding the suitability of its products for any particular purpose, nor does LSC assume any liability for application assistance or customer product design. LSC does not warrant or accept any liability with products which are purchased or used for any unintended or unauthorized application.

No license is granted by implication or otherwise under any intellectual property rights of LSC.

LSC products are not authorized for use as critical components in life support devices or systems without express written approval of LSC.

OBSOLETE