

**Features**

- Epitaxial Planar Die Construction
- Complementary NPN Type Available (DZT853)
- Ideally Suited for Automated Assembly Processes
- Ideal for Medium Power Switching or Amplification Applications
- **Lead Free By Design/RoHS Compliant (Note 1)**
- **"Green" Device (Note 2)**

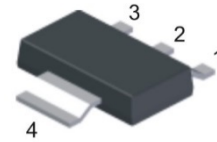

**Mechanical Data**

- Case: SOT-223
- Case Material: Molded Plastic, "Green" Molding Compound. UL Flammability Classification Rating 94V-0
- Moisture Sensitivity: Level 1 per J-STD-020D
- Terminals: Finish — Matte Tin annealed over Copper Leadframe (Lead Free Plating). Solderable per MIL-STD-202, Method 208
- Marking Information: See Page 3
- Ordering Information: See Page 3
- Weight: 0.115 grams (approximate)

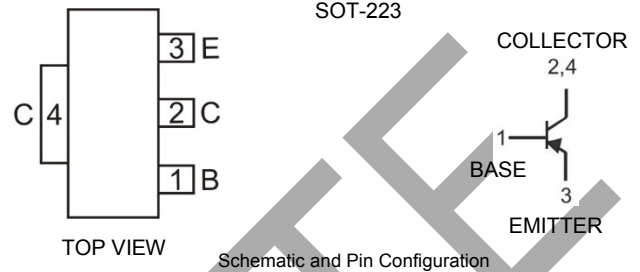

**Maximum Ratings** @ $T_A = 25^\circ\text{C}$  unless otherwise specified

Characteristic	Symbol	Value	Unit
Collector-Base Voltage	$V_{CBO}$	-140	V
Collector-Emitter Voltage	$V_{CEO}$	-100	V
Emitter-Base Voltage	$V_{EBO}$	-6	V
Continuous Collector Current	$I_C$	-5	A
Peak Pulse Collector Current	$I_{CM}$	-10	A
Power Dissipation	$P_D$	1(Note 3) 3(Note 4)	W
Operating and Storage Temperature Range	$T_J, T_{STG}$	-55 to +150	$^\circ\text{C}$

- Notes:
1. No purposefully added lead.
  2. Diodes Inc.'s "Green" policy can be found on our website at [http://www.diodes.com/products/lead\\_free/index.php](http://www.diodes.com/products/lead_free/index.php).
  3. Device mounted on FR-4 PCB, pad layout as shown on page 4.
  4. The power which can be dissipated, assuming the device is mounted in a typical manner on a PCB with copper equal to 4 square inch minimum.

OBSOLETE - PART DISCONTINUED

OBSOLETE

**Electrical Characteristics** @ $T_A = 25^\circ\text{C}$  unless otherwise specified

Characteristic	Symbol	Min	Typ	Max	Unit	Test Condition
<b>OFF CHARACTERISTICS</b>						
Collector-Base Breakdown Voltage	$V_{(BR)CBO}$	-140	-165	—	V	$I_C = -100\mu\text{A}, I_E = 0$
Collector-Emitter Breakdown Voltage	$V_{(BR)CEO}$	-100	-120	—	V	$I_C = -10\text{mA}^*, I_B = 0$
Emitter-Base Breakdown Voltage	$V_{(BR)EBO}$	-6	-9	—	V	$I_E = -100\mu\text{A}, I_C = 0$
Collector Cutoff Current	$I_{CBO}$	—	—	-50 -1	nA $\mu\text{A}$	$V_{CB} = -100\text{V}, I_E = 0$ $V_{CB} = -100\text{V}, I_E = 0, T_A = 100^\circ\text{C}$
Emitter Cutoff Current	$I_{EBO}$	—	—	-10	nA	$V_{EB} = -6\text{V}, I_C = 0$
<b>ON CHARACTERISTICS</b>						
Collector-Emitter Saturation Voltage	$V_{CE(SAT)}$	—	-18 -70 -125 -260	-50 -115 -220 -420	mV	$I_C = -100\text{mA}, I_B = -10\text{mA}^*$ $I_C = -1\text{A}, I_B = -100\text{mA}^*$ $I_C = -2\text{A}, I_B = -200\text{mA}^*$ $I_C = -4\text{A}, I_B = -400\text{mA}^*$
Base-Emitter Saturation Voltage	$V_{BE(SAT)}$	—	-960	-1170	mV	$I_C = -4\text{A}, I_B = -400\text{mA}^*$
Base-Emitter Turn-On Voltage	$V_{BE(ON)}$	—	-880	-1160	mV	$I_{CE} = -4\text{A}, V_{CE} = -1\text{V}^*$
DC Current Gain	$h_{FE}$	100 100 50 30 —	220 200 100 70 15	— 300 — — —	—	$I_C = -10\text{mA}, V_{CE} = -1\text{V}^*$ $I_C = -1\text{A}, V_{CE} = -1\text{V}^*$ $I_C = -3\text{A}, V_{CE} = -1\text{V}^*$ $I_C = -4\text{A}, V_{CE} = -1\text{V}^*$ $I_C = -10\text{A}, V_{CE} = -1\text{V}^*$
<b>SMALL SIGNAL CHARACTERISTICS</b>						
Current Gain-Bandwidth Product	$f_T$	—	125	—	MHz	$I_C = -100\text{mA}, V_{CE} = -10\text{V}, f = 50\text{MHz}$
Output Capacitance	$C_{obo}$	—	65	—	pF	$V_{CB} = -10\text{V}, f = 1\text{MHz}$
<b>SWITCHING CHARACTERISTICS</b>						
Switching Times	$t_{on}$ $t_{off}$	—	65 100	—	ns	$I_C = -2\text{A}, I_{B1} = -200\text{mA}$ $I_{B2} = 200\text{mA}, V_{CC} = -10\text{V}$

\*Measured under pulsed conditions. Pulse width = 300 $\mu\text{s}$ . Duty cycle  $\leq 2\%$

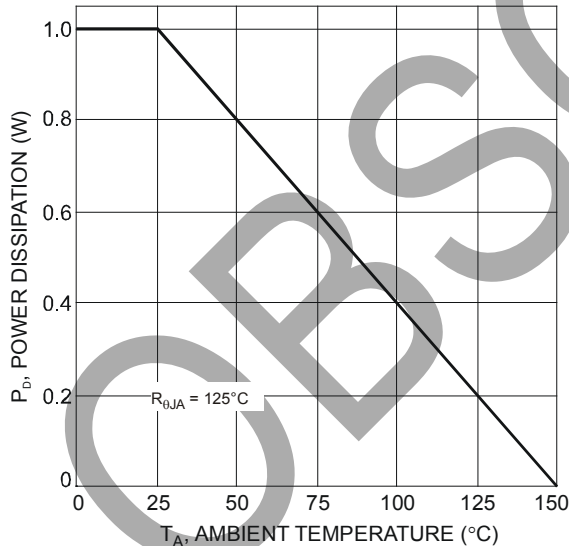

Fig. 1 Power Dissipation vs. Ambient Temperature (Note 3)

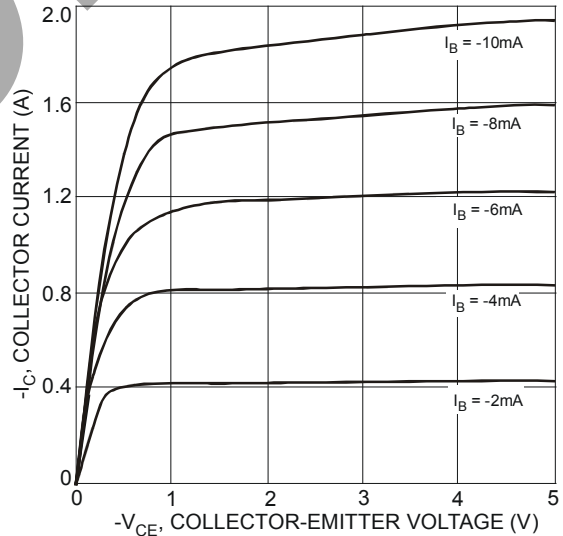

Fig 2. Collector Current vs. Collector Emitter Voltage

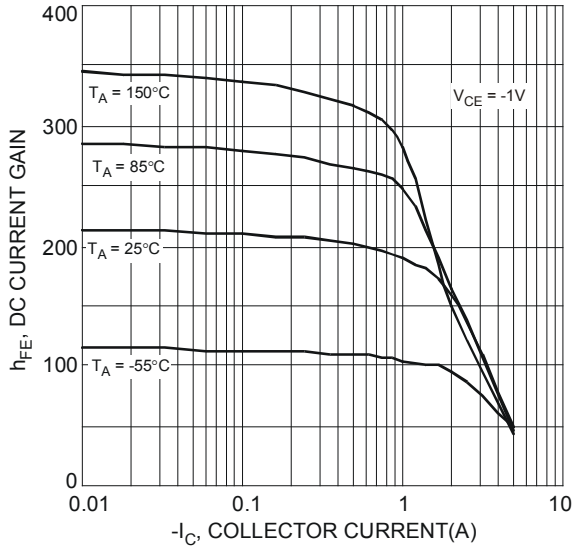

Fig. 3 Typical DC Current Gain vs. Collector Current

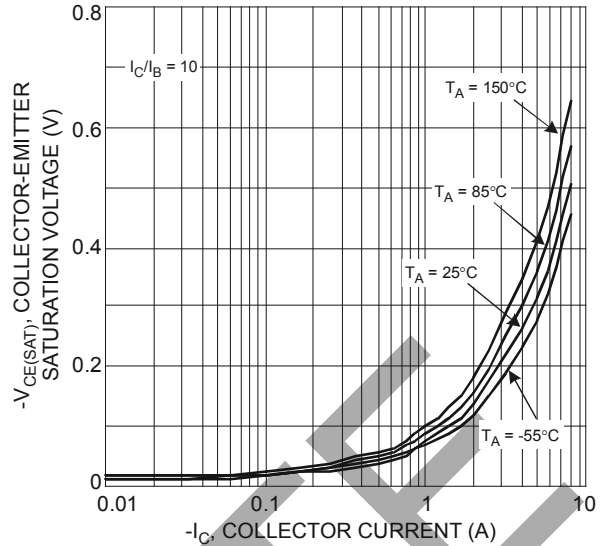

Fig. 4 Collector-Emitter Saturation Voltage vs. Collector Current

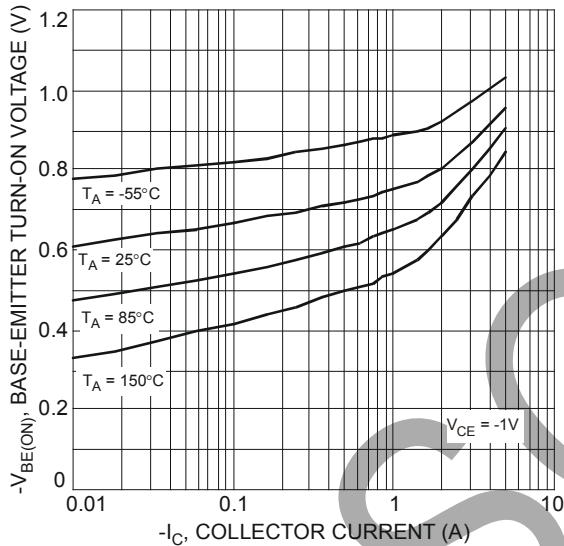

Fig. 5 Base-Emitter Turn-On Voltage vs. Collector Current

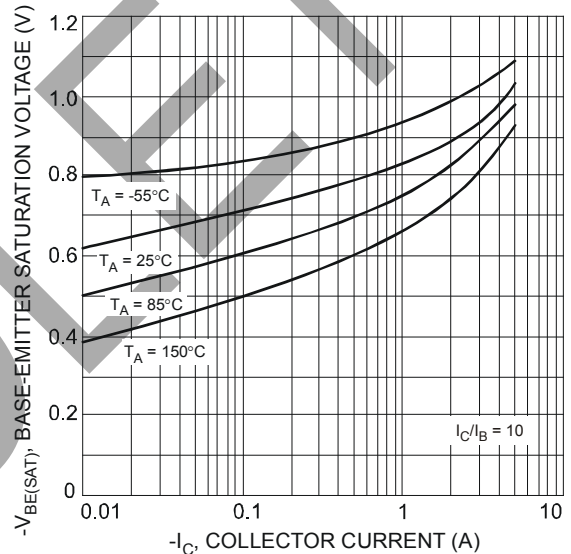

Fig. 6 Base-Emitter Saturation Voltage vs. Collector Current

**Ordering Information** (Note 5)

Device	Valid Marking Codes	Packaging	Shipping
DZT953-13	DZT953	SOT-223	2500/Tape & Reel
DZT953-13	PT06	SOT-223	2500/Tape & Reel

Notes: 5. Packaging Details as shown on page 4, or go to our website at <http://www.diodes.com/ap2007.pdf>.

**Marking Information**

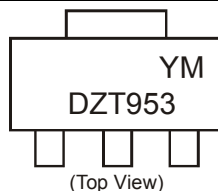

(Top View)

DZT953 or PT06= Product Type Marking Code  
 YM = Date Code Marking  
 Y = Year ex: T = 2006  
 M = Month ex: 9 = September

Date Code Key

Year	2006	2007	2008	2009	2010	2011	2012
Code	T	U	V	W	X	Y	Z

Month	Jan	Feb	Mar	Apr	May	Jun	Jul	Aug	Sep	Oct	Nov	Dec
Code	1	2	3	4	5	6	7	8	9	O	N	D

**Package Outline Dimensions**

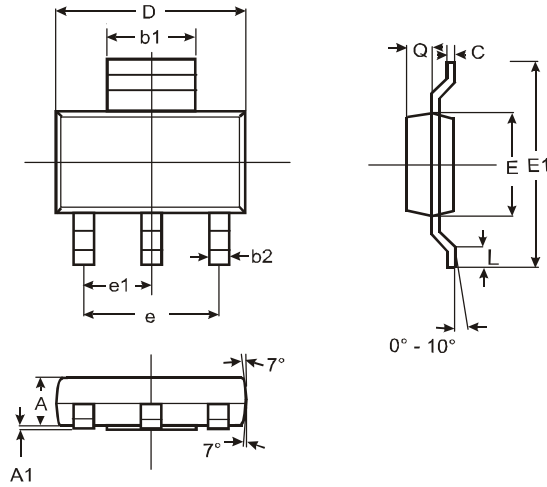

SOT-223			
Dim	Min	Max	Typ
A	1.55	1.65	1.60
A1	0.010	0.15	0.05
b1	2.90	3.10	3.00
b2	0.60	0.80	0.70
C	0.20	0.30	0.25
D	6.45	6.55	6.50
E	3.45	3.55	3.50
E1	6.90	7.10	7.00
e	—	—	4.60
e1	—	—	2.30
L	0.85	1.05	0.95
Q	0.84	0.94	0.89
All Dimensions in mm			

**Suggested Pad Layout:**

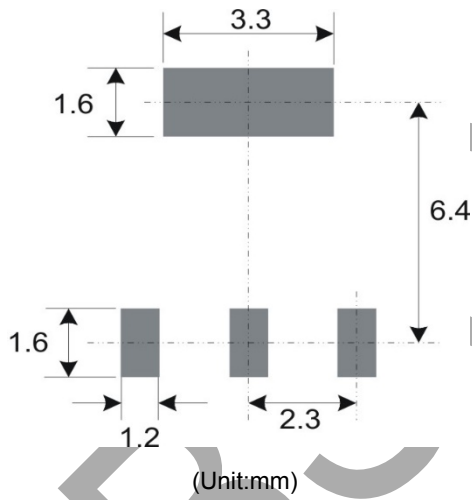

OBSOLETE - PART DISCONTINUED

OBSOLETE

**IMPORTANT NOTICE**

1. DIODES INCORPORATED AND ITS SUBSIDIARIES (“DIODES”) MAKE NO WARRANTY OF ANY KIND, EXPRESS OR IMPLIED, WITH REGARDS TO ANY INFORMATION CONTAINED IN THIS DOCUMENT, INCLUDING, BUT NOT LIMITED TO, THE IMPLIED WARRANTIES OF MERCHANTABILITY, FITNESS FOR A PARTICULAR PURPOSE OR NON-INFRINGEMENT OF THIRD PARTY INTELLECTUAL PROPERTY RIGHTS (AND THEIR EQUIVALENTS UNDER THE LAWS OF ANY JURISDICTION).
2. The Information contained herein is for informational purpose only and is provided only to illustrate the operation of Diodes products described herein and application examples. Diodes does not assume any liability arising out of the application or use of this document or any product described herein. This document is intended for skilled and technically trained engineering customers and users who design with Diodes products. Diodes products may be used to facilitate safety-related applications; however, in all instances customers and users are responsible for (a) selecting the appropriate Diodes products for their applications, (b) evaluating the suitability of the Diodes products for their intended applications, (c) ensuring their applications, which incorporate Diodes products, comply the applicable legal and regulatory requirements as well as safety and functional-safety related standards, and (d) ensuring they design with appropriate safeguards (including testing, validation, quality control techniques, redundancy, malfunction prevention, and appropriate treatment for aging degradation) to minimize the risks associated with their applications.
3. Diodes assumes no liability for any application-related information, support, assistance or feedback that may be provided by Diodes from time to time. Any customer or user of this document or products described herein will assume all risks and liabilities associated with such use, and will hold Diodes and all companies whose products are represented herein or on Diodes’ websites, harmless against all damages and liabilities.
4. Products described herein may be covered by one or more United States, international or foreign patents and pending patent applications. Product names and markings noted herein may also be covered by one or more United States, international or foreign trademarks and trademark applications. Diodes does not convey any license under any of its intellectual property rights or the rights of any third parties (including third parties whose products and services may be described in this document or on Diodes’ website) under this document.
5. Diodes products are provided subject to Diodes’ Standard Terms and Conditions of Sale (<https://www.diodes.com/about/company/terms-and-conditions/terms-and-conditions-of-sales/>) or other applicable terms. This document does not alter or expand the applicable warranties provided by Diodes. Diodes does not warrant or accept any liability whatsoever in respect of any products purchased through unauthorized sales channel.
6. Diodes products and technology may not be used for or incorporated into any products or systems whose manufacture, use or sale is prohibited under any applicable laws and regulations. Should customers or users use Diodes products in contravention of any applicable laws or regulations, or for any unintended or unauthorized application, customers and users will (a) be solely responsible for any damages, losses or penalties arising in connection therewith or as a result thereof, and (b) indemnify and hold Diodes and its representatives and agents harmless against any and all claims, damages, expenses, and attorney fees arising out of, directly or indirectly, any claim relating to any noncompliance with the applicable laws and regulations, as well as any unintended or unauthorized application.
7. While efforts have been made to ensure the information contained in this document is accurate, complete and current, it may contain technical inaccuracies, omissions and typographical errors. Diodes does not warrant that information contained in this document is error-free and Diodes is under no obligation to update or otherwise correct this information. Notwithstanding the foregoing, Diodes reserves the right to make modifications, enhancements, improvements, corrections or other changes without further notice to this document and any product described herein. This document is written in English but may be translated into multiple languages for reference. Only the English version of this document is the final and determinative format released by Diodes.
8. Any unauthorized copying, modification, distribution, transmission, display or other use of this document (or any portion hereof) is prohibited. Diodes assumes no responsibility for any losses incurred by the customers or users or any third parties arising from any such unauthorized use.

Copyright © 2021 Diodes Incorporated

[www.diodes.com](http://www.diodes.com)