

Product Summary

BV _{DSS} (@ T _J Max) (Note 7)	R _{DS(ON)}	I _D T _C = +25°C
1000V	2.2Ω @ V _{GS} = 10V	6A

Description

This new generation MOSFET features low on-resistance and fast switching, making it ideal for high efficiency power management applications.

Applications

- Motor Control
- Backlighting
- DC-DC Converters
- Power Management Functions

Features

- Low Input Capacitance
- High BV_{DSS} Rating for Power Application
- Low Input/Output Leakage
- **Lead-Free Finish; RoHS Compliant (Notes 1 & 2)**
- **Halogen and Antimony Free. "Green" Device (Note 3)**
- **For automotive applications requiring specific change control (i.e. parts qualified to AEC-Q100/101/200, PPAP capable, and manufactured in IATF 16949 certified facilities), please [contact us](mailto:contact@diodes.com) or your local Diodes representative. <https://www.diodes.com/quality/product-definitions/>**

Mechanical Data

- Case: ITO220AB
- Case Material: Molded Plastic, "Green" Molding Compound, UL Flammability Classification Rating 94V-0
- Terminals: Matte Tin Finish Annealed Over Copper Leadframe. Solderable per MIL-STD-202, Method 208 (E3)
- Terminal Connections: See Diagram Below
- Weight: 1.85 grams (Approximate)

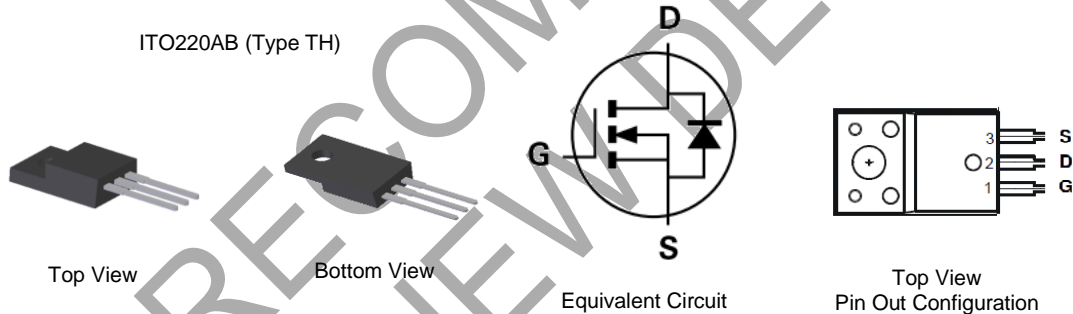

Ordering Information (Note 4)

Part Number	Case	Packaging
DMN90H2D2HCTI	ITO220AB (Type TH)	50 Pieces/Tube

- Notes:
1. EU Directive 2002/95/EC (RoHS), 2011/65/EU (RoHS 2) & 2015/863/EU (RoHS 3) compliant. All applicable RoHS exemptions applied.
 2. See <https://www.diodes.com/quality/lead-free/> for more information about Diodes Incorporated's definitions of Halogen- and Antimony-free, "Green" and Lead-free.
 3. Halogen- and Antimony-free "Green" products are defined as those which contain <900ppm bromine, <900ppm chlorine (<1500ppm total Br + Cl) and <1000ppm antimony compounds.
 4. For packaging details, go to our website at <https://www.diodes.com/design/support/packaging/diodes-packaging/>.

Marking Information

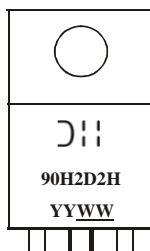

D|| = Manufacturer's Marking
 90H2D2H = Product Type Marking Code
 YYWW = Date Code Marking
 YY or YY = Last Two Digits of Year (ex: 20 = 2020)
 WW or WW = Week Code (01 to 53)

Maximum Ratings (@T_A = +25°C, unless otherwise specified.)

Characteristic	Symbol	Value	Unit
Drain-Source Voltage	V _{DSS}	900	V
Gate-Source Voltage	V _{GSS}	±30	V
Continuous Drain Current (Notes 5) V _{GS} = 10V (Note 6)	I _D	6 4	A
Pulsed Drain Current	I _{DM}	24	A
Avalanche Current, L = 60mH (Note 7)	I _{AS}	3.5	A
Avalanche Energy, L = 60mH (Note 7)	E _{AS}	360	mJ

Thermal Characteristics

Characteristic	Symbol	Max	Unit
Power Dissipation (Note 5)	P _D	40 14	W
Thermal Resistance, Junction to Case (Note 5)	R _{θJC}	3.6	°C/W
Operating and Storage Temperature Range	T _J , T _{STG}	-55 to +150	°C

Electrical Characteristics (@T_A = +25°C, unless otherwise specified.)

Characteristic	Symbol	Min	Typ	Max	Unit	Test Condition
OFF CHARACTERISTICS (Note 8)						
Drain-Source Breakdown Voltage	BV _{DSS}	900	—	—	V	V _{GS} = 0V, I _D = 250μA
Zero Gate Voltage Drain Current	I _{DSS}	—	—	1	μA	V _{DS} = 900V, V _{GS} = 0V
Gate-Source Leakage	I _{GSS}	—	—	100	nA	V _{GS} = ±30V, V _{DS} = 0V
ON CHARACTERISTICS (Note 8)						
Gate Threshold Voltage	V _{GS(TH)}	3	4	5	V	V _{DS} = V _{GS} , I _D = 250μA
Static Drain-Source On-Resistance	R _{DS(ON)}	—	1.7	2.2	Ω	V _{GS} = 10V, I _D = 3A
Diode Forward Voltage	V _{SD}	—	0.85	1.2	V	V _{GS} = 0V, I _S = 6A
DYNAMIC CHARACTERISTICS (Note 7)						
Input Capacitance	C _{iss}	—	1487	—	pF	V _{DS} = 25V, f = 1MHz, V _{GS} = 0V
Output Capacitance	C _{oss}	—	113	—		
Reverse Transfer Capacitance	C _{rss}	—	1	—		
Gate Resistance	R _g	—	4.7	—	Ω	V _{DS} = 0V, V _{GS} = 0V, f = 1MHz
Total Gate Charge	Q _g	—	20.3	—	nC	V _{DD} = 720V, I _D = 6A, V _{GS} = 10V
Gate-Source Charge	Q _{gs}	—	6.4	—		
Gate-Drain Charge	Q _{gd}	—	6.1	—		
Turn-On Delay Time	t _{D(ON)}	—	39	—	ns	V _{DD} = 450V, V _{GS} = 10V, R _g = 25Ω, I _D = 6A
Turn-On Rise Time	t _r	—	49	—		
Turn-Off Delay Time	t _{D(OFF)}	—	51	—		
Turn-Off Fall Time	t _f	—	31	—		
Body Diode Reverse Recovery Time	t _{RR}	—	607	—	ns	I _F = 6A, di/dt = 100A/μs
Body Diode Reverse Recovery Charge	Q _{RR}	—	8.1	—	μC	

- Notes:
- Device mounted on FR-4 substrate PC board, 2oz copper, with minimum recommended pad layout.
 - Drain current limited by maximum junction temperature.
 - Guaranteed by design. Not subject to production testing.
 - Short duration pulse test used to minimize self-heating effect.

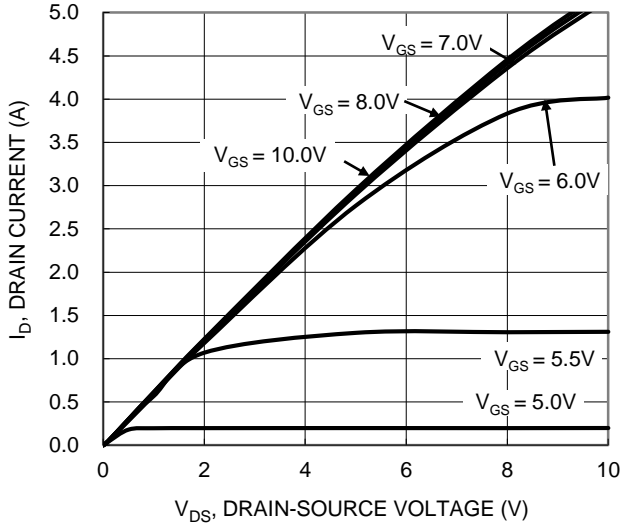

Figure 1. Typical Output Characteristic

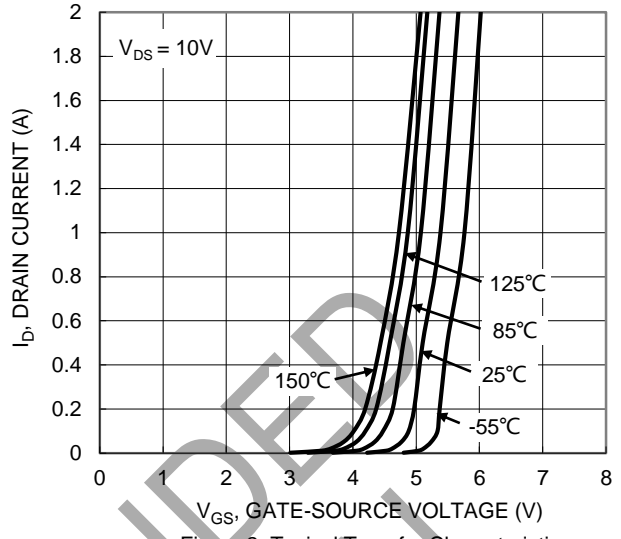

Figure 2. Typical Transfer Characteristic

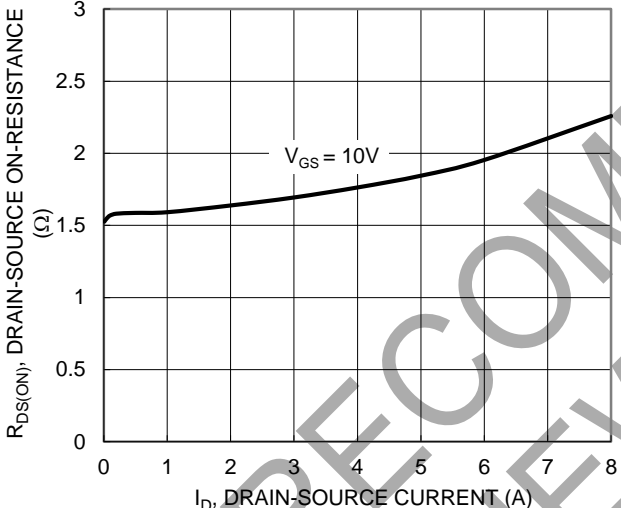

Figure 3. Typical On-Resistance vs. Drain Current and Gate Voltage

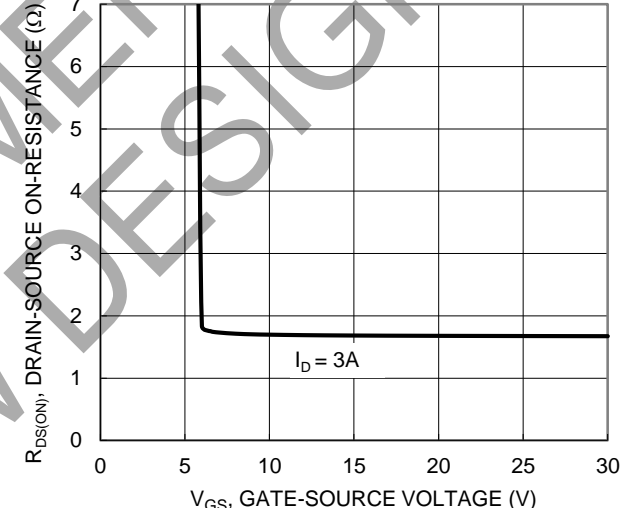

Figure 4. Typical Transfer Characteristic

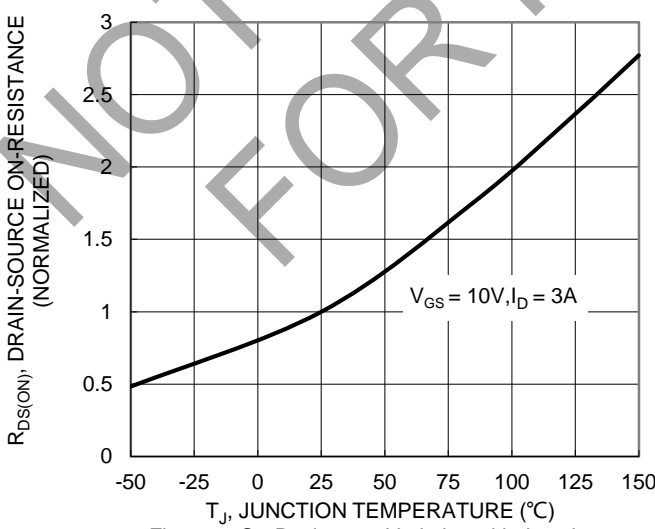

Figure 5. On-Resistance Variation with Junction Temperature

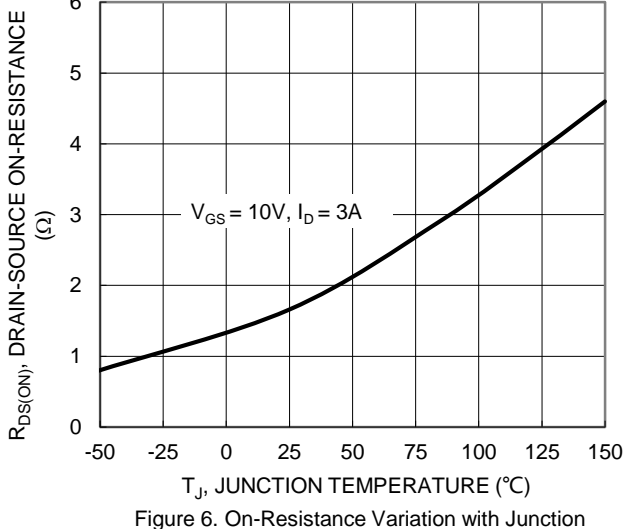

Figure 6. On-Resistance Variation with Junction Temperature

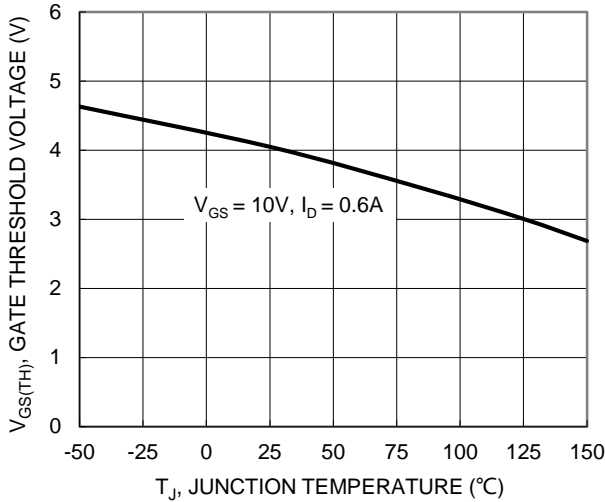

Figure 7. Gate Threshold Variation vs. Junction Temperature

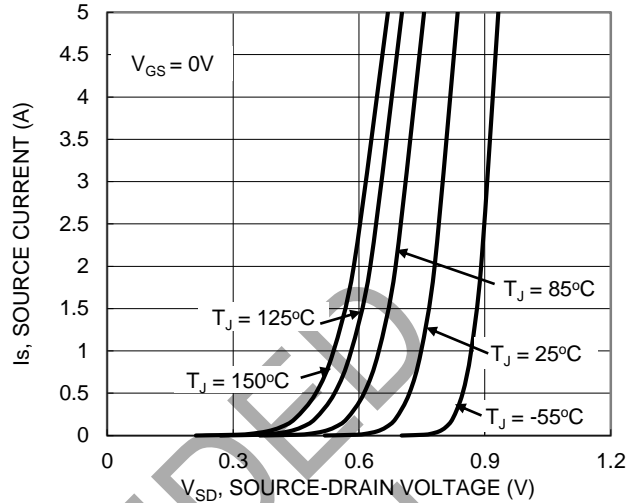

Figure 8. Diode Forward Voltage vs. Current

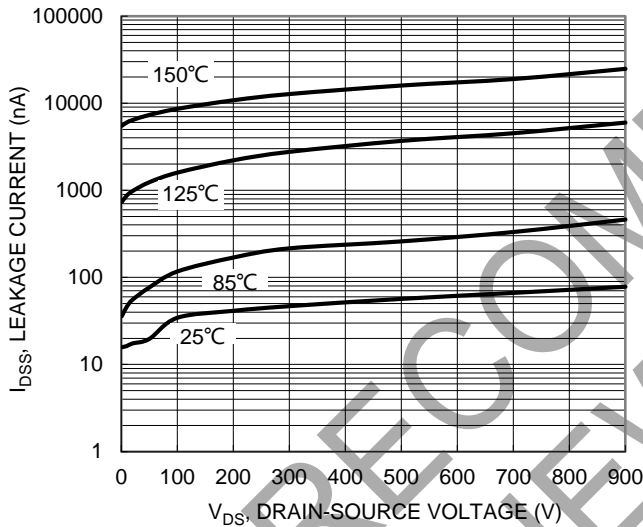

Figure 9. Typical Drain-Source Leakage Current vs. Voltage

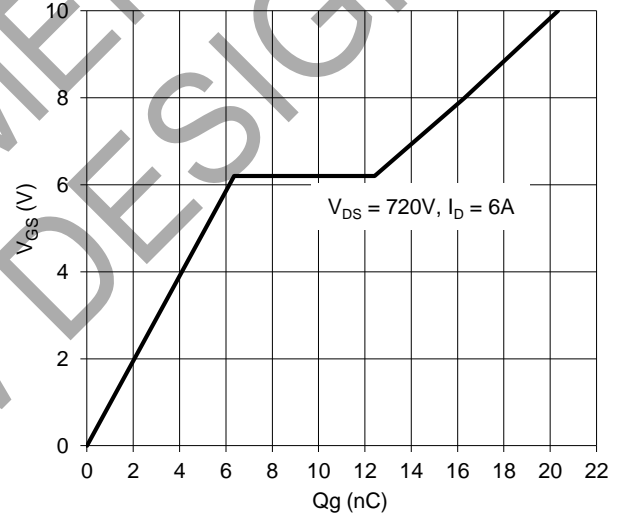

Figure 10. Gate Charge

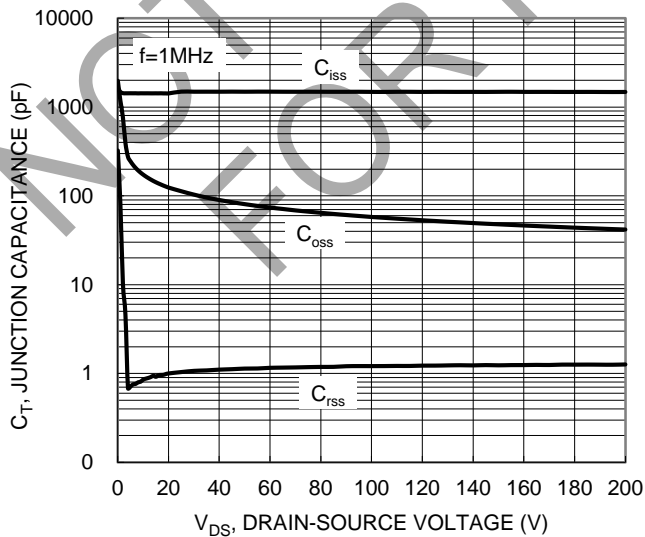

Figure 11. Typical Junction Capacitance

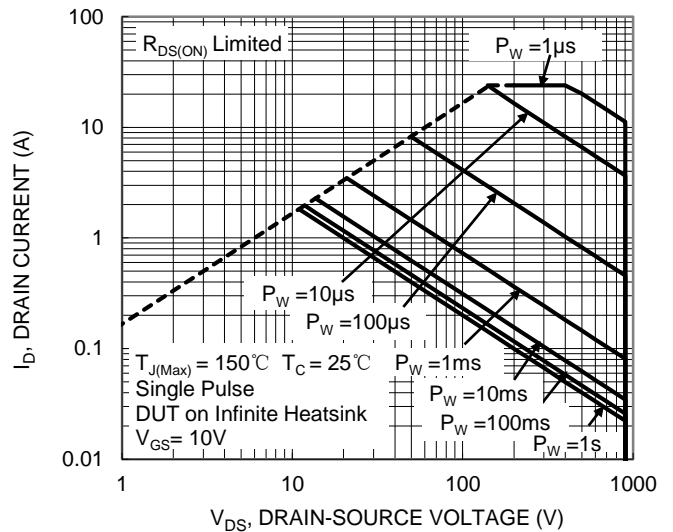

Figure 12. SOA, Safe Operation Area

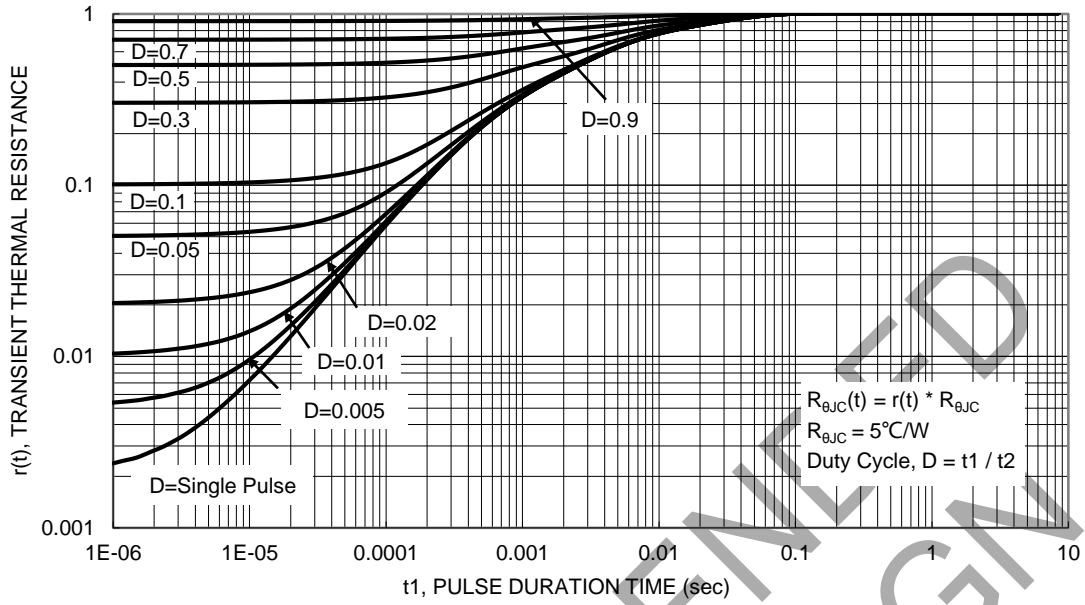

Figure 13. Transient Thermal Resistance

NOT RECOMMENDED FOR NEW DESIGN

Package Outline Dimensions

Please see <http://www.diodes.com/package-outlines.html> for the latest version.

ITO220AB (Type TH)

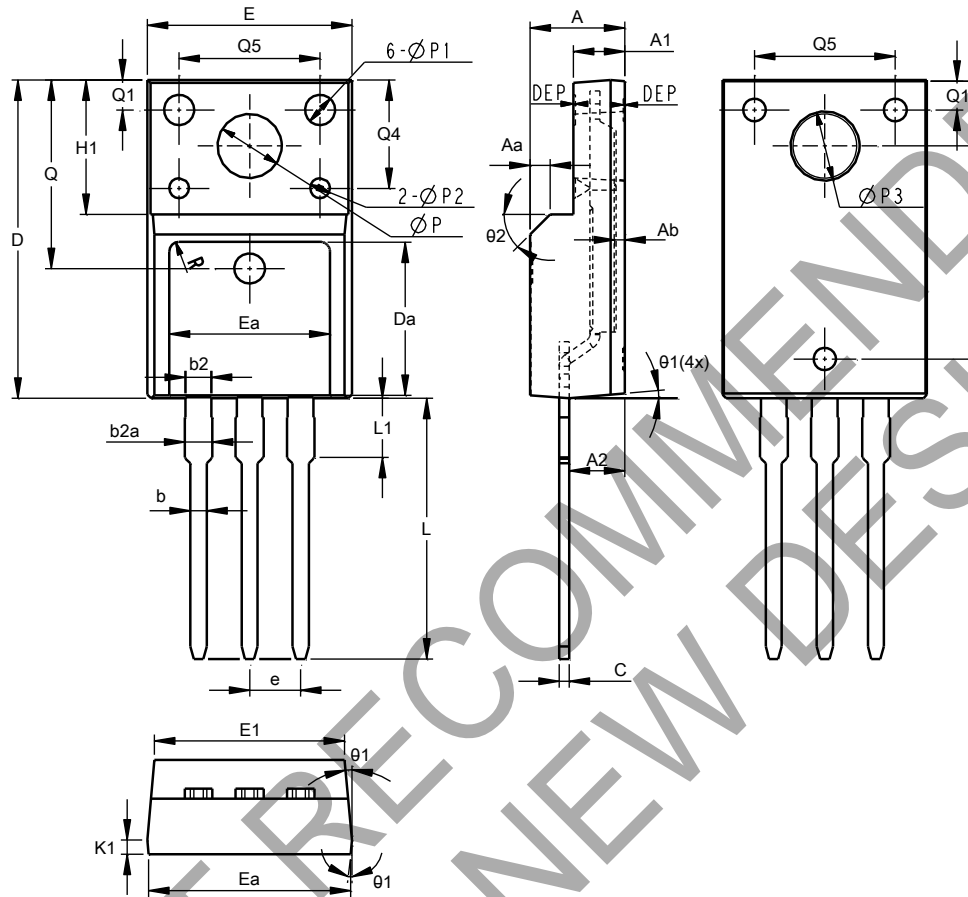

ITO220AB (Type TH)			
Dim	Min	Max	Typ
A	4.50	4.90	4.70
A1	2.34	2.74	2.54
A2	2.63	2.89	2.76
Aa	1.00 REF		
Ab	0.30	0.60	0.56
b	0.75	0.90	0.80
b2	1.23	1.38	1.28
b2a	1.25	1.45	1.35
c	0.45	0.60	0.50
D	15.47	16.27	15.87
Da	7.55	8.05	7.80
e	2.54 BSC		
E	9.86	10.46	10.16
E1	9.26	9.66	9.46
Ea	7.70	8.30	8.00
Eb	9.76	10.34	10.04
H1	6.70 REF		
L	12.58	13.38	12.98
L1	2.81	3.05	2.93
K1	0.65	0.75	0.70
Q	9.40 REF		
Q1	1.00	2.00	1.50
Q2	13.50	14.30	13.90
Q3	3.15	3.45	3.30
Q4	5.15	5.65	5.40
Q5	6.70	7.30	7.00
ØP	3.06	3.40	3.18
ØP1	1.40	1.60	1.50
ØP2	0.95	1.05	1.00
ØP3	3.30	3.60	3.45
θ1	3°	7°	5°
θ2	-	45°	-
R	0.50 REF		
DEP	0.05	0.15	0.10
All Dimensions in mm			

IMPORTANT NOTICE

1. DIODES INCORPORATED AND ITS SUBSIDIARIES (“DIODES”) MAKE NO WARRANTY OF ANY KIND, EXPRESS OR IMPLIED, WITH REGARDS TO ANY INFORMATION CONTAINED IN THIS DOCUMENT, INCLUDING, BUT NOT LIMITED TO, THE IMPLIED WARRANTIES OF MERCHANTABILITY, FITNESS FOR A PARTICULAR PURPOSE OR NON-INFRINGEMENT OF THIRD PARTY INTELLECTUAL PROPERTY RIGHTS (AND THEIR EQUIVALENTS UNDER THE LAWS OF ANY JURISDICTION).
2. The Information contained herein is for informational purpose only and is provided only to illustrate the operation of Diodes products described herein and application examples. Diodes does not assume any liability arising out of the application or use of this document or any product described herein. This document is intended for skilled and technically trained engineering customers and users who design with Diodes products. Diodes products may be used to facilitate safety-related applications; however, in all instances customers and users are responsible for (a) selecting the appropriate Diodes products for their applications, (b) evaluating the suitability of the Diodes products for their intended applications, (c) ensuring their applications, which incorporate Diodes products, comply the applicable legal and regulatory requirements as well as safety and functional-safety related standards, and (d) ensuring they design with appropriate safeguards (including testing, validation, quality control techniques, redundancy, malfunction prevention, and appropriate treatment for aging degradation) to minimize the risks associated with their applications.
3. Diodes assumes no liability for any application-related information, support, assistance or feedback that may be provided by Diodes from time to time. Any customer or user of this document or products described herein will assume all risks and liabilities associated with such use, and will hold Diodes and all companies whose products are represented herein or on Diodes’ websites, harmless against all damages and liabilities.
4. Products described herein may be covered by one or more United States, international or foreign patents and pending patent applications. Product names and markings noted herein may also be covered by one or more United States, international or foreign trademarks and trademark applications. Diodes does not convey any license under any of its intellectual property rights or the rights of any third parties (including third parties whose products and services may be described in this document or on Diodes’ website) under this document.
5. Diodes products are provided subject to Diodes’ Standard Terms and Conditions of Sale (<https://www.diodes.com/about/company/terms-and-conditions/terms-and-conditions-of-sales/>) or other applicable terms. This document does not alter or expand the applicable warranties provided by Diodes. Diodes does not warrant or accept any liability whatsoever in respect of any products purchased through unauthorized sales channel.
6. Diodes products and technology may not be used for or incorporated into any products or systems whose manufacture, use or sale is prohibited under any applicable laws and regulations. Should customers or users use Diodes products in contravention of any applicable laws or regulations, or for any unintended or unauthorized application, customers and users will (a) be solely responsible for any damages, losses or penalties arising in connection therewith or as a result thereof, and (b) indemnify and hold Diodes and its representatives and agents harmless against any and all claims, damages, expenses, and attorney fees arising out of, directly or indirectly, any claim relating to any noncompliance with the applicable laws and regulations, as well as any unintended or unauthorized application.
7. While efforts have been made to ensure the information contained in this document is accurate, complete and current, it may contain technical inaccuracies, omissions and typographical errors. Diodes does not warrant that information contained in this document is error-free and Diodes is under no obligation to update or otherwise correct this information. Notwithstanding the foregoing, Diodes reserves the right to make modifications, enhancements, improvements, corrections or other changes without further notice to this document and any product described herein. This document is written in English but may be translated into multiple languages for reference. Only the English version of this document is the final and determinative format released by Diodes.
8. Any unauthorized copying, modification, distribution, transmission, display or other use of this document (or any portion hereof) is prohibited. Diodes assumes no responsibility for any losses incurred by the customers or users or any third parties arising from any such unauthorized use.

Copyright © 2020 Diodes Incorporated

www.diodes.com