

## Features

- Ideally Suited for Automatic Insertion
- Complementary NPN Types: BC846 – BC848
- For Switching and AF Amplifier Applications
- **Totally Lead-Free & Fully RoHS Compliant (Notes 1 & 2)**
- **Halogen- and Antimony-Free. "Green" Device (Note 3)**
- For automotive applications requiring specific change control (i.e.: parts qualified to AEC-Q100/101/200, PPAP capable, and manufactured in IATF 16949 certified facilities), please refer to the related automotive grade (Q-suffix) part. A listing can be found at <https://www.diodes.com/products/automotive/automotive-products/>.
- This part is qualified to JEDEC standards (as references in AEC-Q) for High Reliability. <https://www.diodes.com/quality/product-definitions/>

## Mechanical Data

- Case: SOT23
- Case Material: Molded Plastic, "Green" Molding Compound. UL Flammability Classification Rating 94V-0
- Moisture Sensitivity: Level 1 per J-STD-020
- Terminals: Finish – Matte Tin Plated Leads, Solderable per MIL-STD-202, Method 208 <sup>(e3)</sup>
- Weight: 0.008 grams (Approximate)

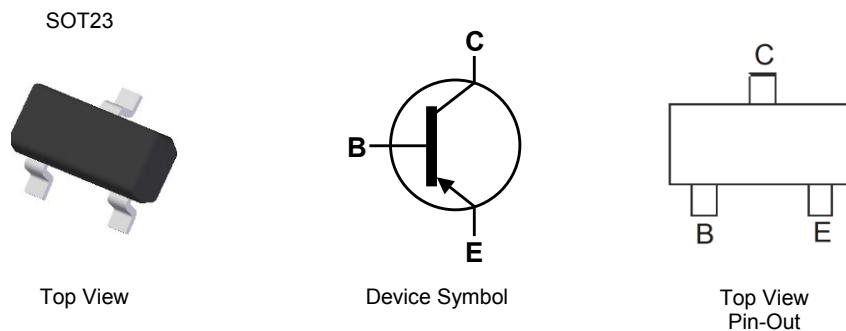

## Ordering Information (Note 4)

Product	Compliance	Marking	Reel Size (Inches)	Quantity per Reel
BC856A-7-F	Standard	K3A	7	3,000
BC856B-7-F	Standard	K3B	7	3,000
BC856B-13-F	Standard	K3B	13	10,000
BC857A-7-F	Standard	K3A	7	3,000
BC857B-7-F	Standard	K3B	7	3,000
BC857B-13-F	Standard	K3B	13	10,000
BC857C-7-F	Standard	K3G	7	3,000
BC857C-13-F	Standard	K3G	13	10,000
BC858A-7-F	Standard	K3A	7	3,000
BC858B-7-F	Standard	K3B	7	3,000
BC858C-7-F	Standard	K3G	7	3,000

- Notes:
1. No purposely added lead. Fully EU Directive 2002/95/EC (RoHS), 2011/65/EU (RoHS 2) & 2015/863/EU (RoHS 3) compliant.
  2. See <https://www.diodes.com/quality/lead-free/> for more information about Diodes Incorporated's definitions of Halogen- and Antimony-free, "Green" and Lead-free.
  3. Halogen- and Antimony-free "Green" products are defined as those which contain <900ppm bromine, <900ppm chlorine (<1500ppm total Br + Cl) and <1000ppm antimony compounds.
  4. For packaging details, go to our website at <https://www.diodes.com/design/support/packaging/diodes-packaging/>.

## Marking Information

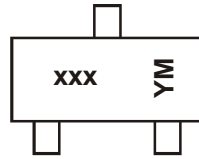

xxx = Product Type Marking Code  
 (Please see Ordering Information)  
 YM = Date Code Marking  
 Y or  $\bar{Y}$  = Year (ex: G = 2019)  
 M or  $\bar{M}$  = Month (ex: 9 = September)

### Date Code Key

Year	2019	2020	2021	2022	2023	2024	2025	2026
Code	G	H	I	J	K	L	M	N

Month	Jan	Feb	Mar	Apr	May	Jun	Jul	Aug	Sep	Oct	Nov	Dec
Code	1	2	3	4	5	6	7	8	9	O	N	D

## Absolute Maximum Ratings (@ T<sub>A</sub> = +25°C, unless otherwise specified.)

Characteristic	Symbol	Value	Unit
Collector-Base Voltage	V <sub>CBO</sub>	BC856	-80
		BC857	-50
		BC858	-30
Collector-Emitter Voltage	V <sub>CEO</sub>	BC856	-65
		BC857	-45
		BC858	-30
Emitter-Base Voltage	V <sub>EBO</sub>	-5.0	V
Continuous Collector Current	I <sub>C</sub>	-100	mA
Peak Collector Current (Single Pulse)	I <sub>CM</sub>	-200	mA
Peak Emitter Current	I <sub>EM</sub>	-200	mA
Peak Base Current (Single Pulse)	I <sub>BM</sub>	-200	mA

## Thermal Characteristics (@ T<sub>A</sub> = +25°C, unless otherwise specified.)

Characteristic	Symbol	Value	Unit
Power Dissipation	P <sub>D</sub>	(Note 5)	310
		(Note 6)	350
Thermal Resistance, Junction to Ambient	R <sub>θJA</sub>	(Note 5)	403
		(Note 6)	357
Thermal Resistance, Junction to Leads	R <sub>θJL</sub>	350	°C/W
Operating and Storage Temperature Range	T <sub>J</sub> , T <sub>STG</sub>	-55 to +150	°C

## ESD Ratings (Note 8)

Characteristic	Symbol	Value	Unit	JEDEC Class
Electrostatic Discharge - Human Body Model	ESD HBM	4,000	V	3A
Electrostatic Discharge - Machine Model	ESD MM	400	V	C

- Notes:
5. For a device mounted on minimum recommended pad layout 1oz copper that is on a single-sided FR-4 PCB; device is measured under still air conditions whilst operating in a steady-state.
  6. Same as Note 5, except the device is mounted on 15mm × 15mm 1oz copper.
  7. Thermal resistance from junction to solder-point (at the end of the leads).
  8. Refer to JEDEC specification JESD22-A114 and JESD22-A115.

**Thermal Characteristics and Derating Information**

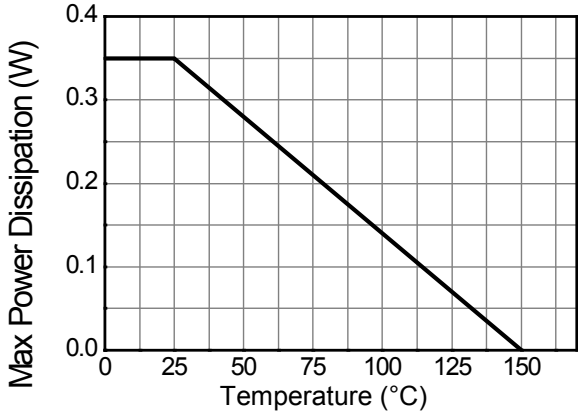

**Derating Curve**

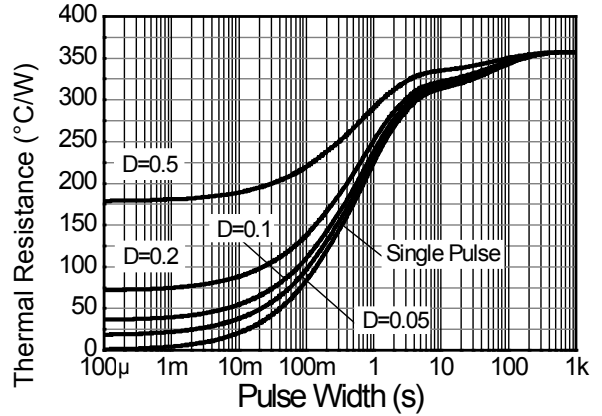

**Transient Thermal Impedance**

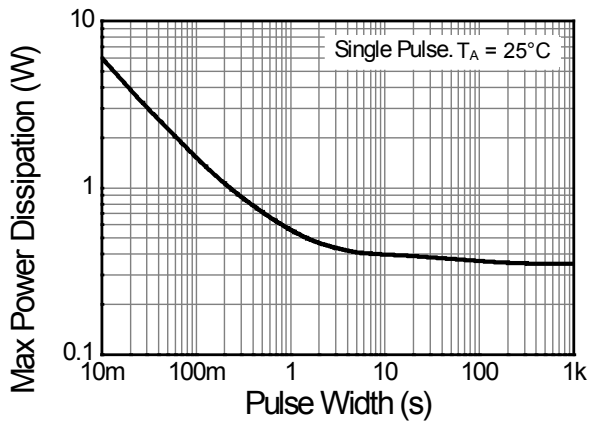

**Pulse Power Dissipation**

**Electrical Characteristics** (@ T<sub>A</sub> = +25°C, unless otherwise specified.)

Characteristic		Symbol	Min	Typ	Max	Unit	Test Condition
Collector-Base Breakdown Voltage	BC856	BV <sub>CBO</sub>	-80	—	—	V	I <sub>C</sub> = -10μA
	BC857		-50				
	BC858		-30				
Collector-Emitter Breakdown Voltage (Note 9)	BC856	BV <sub>CEO</sub>	-65	—	—	V	I <sub>C</sub> = -10mA
	BC857		-45				
	BC858		-30				
Emitter-Base Breakdown Voltage		BV <sub>EBO</sub>	-5	—	—	V	I <sub>E</sub> = -1μA
Collector Cutoff Current		I <sub>CBO</sub>	—	—	-15	nA	V <sub>CB</sub> = -30V
					-4		μA
Collector Emitter Cutoff Current	BC856	I <sub>CES</sub>	—	—	-15	nA	V <sub>CE</sub> = -80V
	BC857				-15		V <sub>CE</sub> = -50V
	BC858				-15		V <sub>CE</sub> = -30V
Emitter-Base Cutoff Current		I <sub>EBO</sub>	—	—	-100	nA	V <sub>EB</sub> = -5V
Small Signal Current Gain	BC856A / BC857A / BC858A	h <sub>fe</sub>	—	200	—	—	I <sub>C</sub> = -2.0mA, V <sub>CE</sub> = -5V f = 1.0kHz
	BC856B / BC857B / BC858B			330			
	BC857C / BC858C			600			
Input Impedance	BC856A / BC857A / BC858A	h <sub>ie</sub>	—	2.7	—	kΩ	
	BC856B / BC857B / BC858B			4.5			
	BC857C / BC858C			8.7			
Output Admittance	BC856A / BC857A / BC858A	h <sub>oe</sub>	—	18	—	μS	
	BC856B / BC857B / BC858B			30			
	BC857C / BC858C			60			
Reverse Voltage Transfer Ratio	BC856A / BC857A / BC858A	h <sub>re</sub>	—	1.5x10 <sup>-4</sup>	—	—	
	BC856B / BC857B / BC858B			2x10 <sup>-4</sup>			
	BC857C / BC858C			3x10 <sup>-4</sup>			
DC Current Gain (Note 9)	BC856A / BC857A / BC858A	h <sub>FE</sub>	125	180	250	—	I <sub>C</sub> = -2.0mA, V <sub>CE</sub> = -5V
	BC856B / BC857B / BC858B		220	290	475		
	BC857C / BC858C		420	520	800		
Collector-Emitter Saturation Voltage (Note 9)		V <sub>CE(sat)</sub>	—	-75	-300	mV	I <sub>C</sub> = -10mA, I <sub>B</sub> = -0.5mA
				-250	-650		I <sub>C</sub> = -100mA, I <sub>B</sub> = -5.0mA
Base-Emitter Turn-On Voltage (Note 9)		V <sub>BE(on)</sub>	—	-600	-650	mV	I <sub>C</sub> = -2mA, V <sub>CE</sub> = -5V
				—	-820		I <sub>C</sub> = -10mA, V <sub>CE</sub> = -5V
Base-Emitter Saturation Voltage (Note 9)		V <sub>BE(sat)</sub>	—	-700	—	mV	I <sub>C</sub> = -10mA, I <sub>B</sub> = -0.5mA
				-850	-1100		I <sub>C</sub> = -100mA, I <sub>B</sub> = -5mA
Output Capacitance		C <sub>obo</sub>	—	3	—	pF	V <sub>CB</sub> = -10V, f = 1.0MHz
Transition Frequency		f <sub>T</sub>	100	200	—	MHz	V <sub>CE</sub> = -5V, I <sub>C</sub> = -10mA, f = 100MHz
Noise Figure		NF	—	2	10	dB	V <sub>CE</sub> = -5V, I <sub>C</sub> = -200μA R <sub>S</sub> = 2kΩ, f = 1kHz Δf = 200Hz

Note: 9. Measured under pulsed conditions. Pulse width ≤ 300μs. Duty cycle ≤ 2%.

**Typical Electrical Characteristics (BC856B) (@  $T_A = +25^\circ\text{C}$ , unless otherwise specified.)**

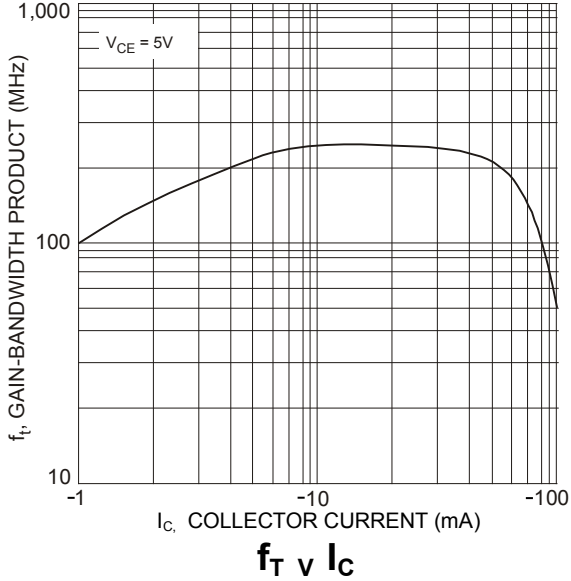
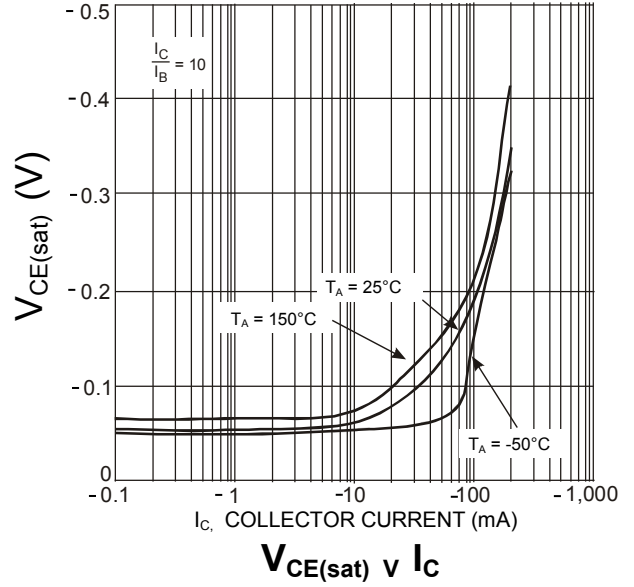
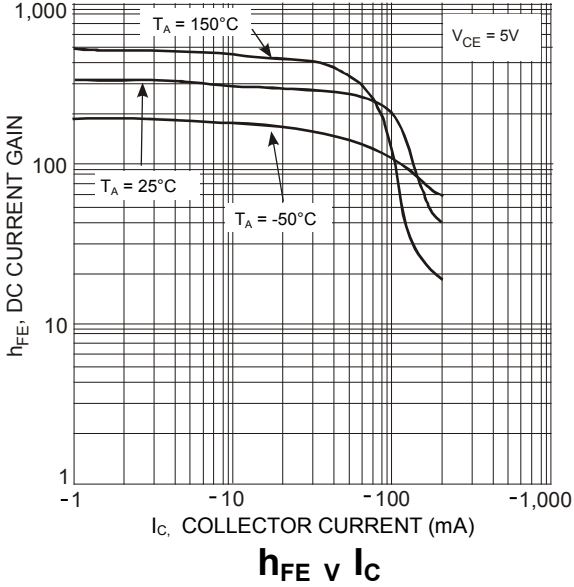

**Package Outline Dimensions**

Please see <http://www.diodes.com/package-outlines.html> for the latest version.

**SOT23**

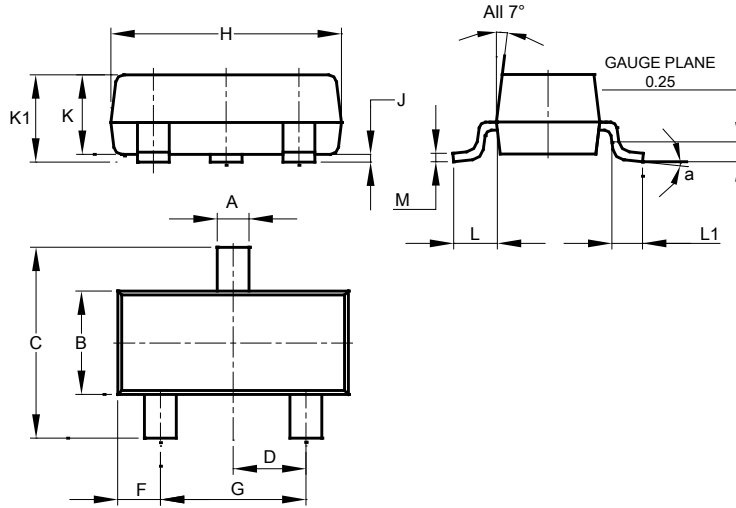

SOT23			
Dim	Min	Max	Typ
A	0.37	0.51	0.40
B	1.20	1.40	1.30
C	2.30	2.50	2.40
D	0.89	1.03	0.915
F	0.45	0.60	0.535
G	1.78	2.05	1.83
H	2.80	3.00	2.90
J	0.013	0.10	0.05
K	0.890	1.00	0.975
K1	0.903	1.10	1.025
L	0.45	0.61	0.55
L1	0.25	0.55	0.40
M	0.085	0.150	0.110
a	0°	8°	--
All Dimensions in mm			

**Suggested Pad Layout**

Please see <http://www.diodes.com/package-outlines.html> for the latest version.

**SOT23**

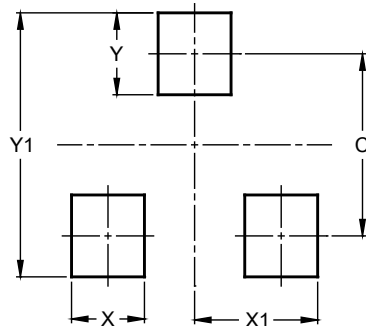

Dimensions	Value (in mm)
C	2.0
X	0.8
X1	1.35
Y	0.9
Y1	2.9

**IMPORTANT NOTICE**

1. DIODES INCORPORATED AND ITS SUBSIDIARIES (“DIODES”) MAKE NO WARRANTY OF ANY KIND, EXPRESS OR IMPLIED, WITH REGARDS TO ANY INFORMATION CONTAINED IN THIS DOCUMENT, INCLUDING, BUT NOT LIMITED TO, THE IMPLIED WARRANTIES OF MERCHANTABILITY, FITNESS FOR A PARTICULAR PURPOSE OR NON-INFRINGEMENT OF THIRD PARTY INTELLECTUAL PROPERTY RIGHTS (AND THEIR EQUIVALENTS UNDER THE LAWS OF ANY JURISDICTION).
2. The Information contained herein is for informational purpose only and is provided only to illustrate the operation of Diodes products described herein and application examples. Diodes does not assume any liability arising out of the application or use of this document or any product described herein. This document is intended for skilled and technically trained engineering customers and users who design with Diodes products. Diodes products may be used to facilitate safety-related applications; however, in all instances customers and users are responsible for (a) selecting the appropriate Diodes products for their applications, (b) evaluating the suitability of the Diodes products for their intended applications, (c) ensuring their applications, which incorporate Diodes products, comply the applicable legal and regulatory requirements as well as safety and functional-safety related standards, and (d) ensuring they design with appropriate safeguards (including testing, validation, quality control techniques, redundancy, malfunction prevention, and appropriate treatment for aging degradation) to minimize the risks associated with their applications.
3. Diodes assumes no liability for any application-related information, support, assistance or feedback that may be provided by Diodes from time to time. Any customer or user of this document or products described herein will assume all risks and liabilities associated with such use, and will hold Diodes and all companies whose products are represented herein or on Diodes’ websites, harmless against all damages and liabilities.
4. Products described herein may be covered by one or more United States, international or foreign patents and pending patent applications. Product names and markings noted herein may also be covered by one or more United States, international or foreign trademarks and trademark applications. Diodes does not convey any license under any of its intellectual property rights or the rights of any third parties (including third parties whose products and services may be described in this document or on Diodes’ website) under this document.
5. Diodes products are provided subject to Diodes’ Standard Terms and Conditions of Sale (<https://www.diodes.com/about/company/terms-and-conditions/terms-and-conditions-of-sales/>) or other applicable terms. This document does not alter or expand the applicable warranties provided by Diodes. Diodes does not warrant or accept any liability whatsoever in respect of any products purchased through unauthorized sales channel.
6. Diodes products and technology may not be used for or incorporated into any products or systems whose manufacture, use or sale is prohibited under any applicable laws and regulations. Should customers or users use Diodes products in contravention of any applicable laws or regulations, or for any unintended or unauthorized application, customers and users will (a) be solely responsible for any damages, losses or penalties arising in connection therewith or as a result thereof, and (b) indemnify and hold Diodes and its representatives and agents harmless against any and all claims, damages, expenses, and attorney fees arising out of, directly or indirectly, any claim relating to any noncompliance with the applicable laws and regulations, as well as any unintended or unauthorized application.
7. While efforts have been made to ensure the information contained in this document is accurate, complete and current, it may contain technical inaccuracies, omissions and typographical errors. Diodes does not warrant that information contained in this document is error-free and Diodes is under no obligation to update or otherwise correct this information. Notwithstanding the foregoing, Diodes reserves the right to make modifications, enhancements, improvements, corrections or other changes without further notice to this document and any product described herein. This document is written in English but may be translated into multiple languages for reference. Only the English version of this document is the final and determinative format released by Diodes.
8. Any unauthorized copying, modification, distribution, transmission, display or other use of this document (or any portion hereof) is prohibited. Diodes assumes no responsibility for any losses incurred by the customers or users or any third parties arising from any such unauthorized use.

Copyright © 2020 Diodes Incorporated

[www.diodes.com](http://www.diodes.com)