

T12M5T600B(LS)

Sensitive Gate Triacs Silicon Bidirectional Thyristors

TRIACS 12 AMPERES RMS 600 VOLTS

FEATURES

- Blocking voltage to 600V
- High Surge Current Capability - 90 Amperes
- Glass Passivated Junctions for Reliability and Uniformity
- Maximum Values of IGT, VGT and IH Specified for Ease of Design
- Operational in Three Quadrants: Q1, Q2, and Q3
- **Lead-Free Finish; RoHS Compliant (Notes 1 & 2)**
- **Halogen and Antimony Free. "Green" Device (Note 3)**

MECHANICAL DATA

- Package: TO-220AB
- Package Material: Molded Plastic, "Green" Molding Compound. UL Flammability Classification Rating 94V-0
- Terminals: Finish – Matte Tin Plated Leads, Solderable per MIL-STD-202, Method 208 (e3)
- Weight: 0.07 ounces, 2.0 grams (Approximate)

TO-220AB

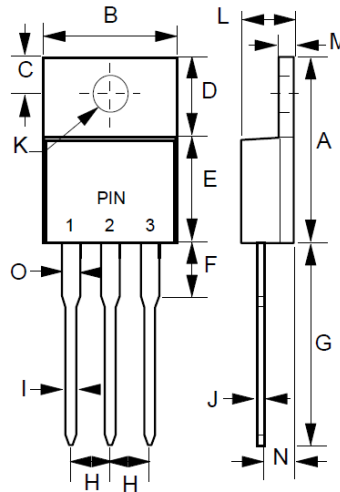

TO-220AB		
DIM.	MIN.	MAX
A	14.22	15.88
B	9.65	10.67
C	2.54	3.43
D	5.84	6.86
E	8.26	9.28
F	--	6.35
G	12.70	14.73
H	2.29	2.79
I	0.51	1.14
J	0.40	0.67
K	3.53Ø	4.09Ø
L	3.56	4.83
M	1.14	1.40
N	2.03	2.92
O	1.17	1.37

All Dimensions in millimeter.

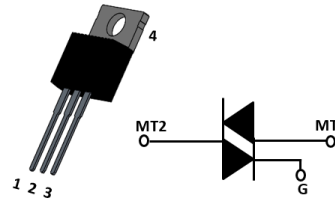

PIN ASSIGNMENT	
1	Main terminal 1
2	Main terminal 2
3	Gate
4	Main terminal 2

MAXIMUM RATINGS AND ELECTRICAL CHARACTERISTICS

Ratings at +25°C ambient temperature unless otherwise specified.

MAXIMUM RATINGS

PARAMETER	SYMBOL	VALUE	UNIT
Peak repetitive off-state voltage ($T_J = -40$ to $+110^\circ\text{C}$, sine wave, 50 to 60Hz; gate open)	V_{DRM} V_{RRM}	600 600	Volts
On-stage RMS current (full sine wave 50 to 60Hz, $T_C = +70^\circ\text{C}$)	$I_{T(RMS)}$	12	Amp
Peak non-repetitive surge current (one full cycle 60Hz, $T_J = +25^\circ\text{C}$)	I_{TSM}	90	Amps
Circuit fusing consideration ($t = 8.3\text{ms}$)	I^2t	33	A^2s
Operating junction temperature range	T_J	-40 to +110	$^\circ\text{C}$
Storage temperature range	T_{STG}	-40 to +150	$^\circ\text{C}$

Notes:

1. EU Directive 2002/95/EC (RoHS), 2011/65/EU (RoHS 2) & 2015/863/EU (RoHS 3) compliant. All applicable RoHS exemptions applied.
2. See <https://www.diodes.com/quality/lead-free/> for more information about Diodes Incorporated's definitions of Halogen- and Antimony-free, "Green" and Lead-free.
3. Halogen- and Antimony-free "Green" products are defined as those which contain <900ppm bromine, <900ppm chlorine (<1500ppm total Br + Cl) and <1000ppm antimony compounds.
4. V_{DRM} and V_{RRM} for all types can be applied on a continuous basis. Blocking, voltages shall not be tested with a constant current source such that the voltage ratings of the devices are exceeded.

OFF CHARACTERISTICS

PARAMETER		SYMBOL	MAX	UNIT
Peak repetitive forward or reverse blocking current ($V_{AK} = \text{rated } V_{DRM}$ and V_{RRM} , gate open)	$T_J = +25^\circ\text{C}$	I_{DRM}	10	μA
	$T_J = +110^\circ\text{C}$	I_{RRM}	2	mA

ON CHARACTERISTICS

PARAMETER	SYMBOL	MAX	UNIT
Peak forward on-state voltage ($I_{TM} = \pm 12\text{A Peak @ } t_P \leq 2.0\text{ms}$, duty cycle $\leq 2\%$)	V_{TM}	1.85	Volts
Gate trigger current ($V_D = 12\text{V}$, $R_L = 100\Omega$)	I_{GT1}	5	mA
	I_{GT2}	5	
	I_{GT3}	5	
Gate trigger voltage ($V_D = 12\text{V}$, $R_L = 100\Omega$)	V_{GT1}	1.5	Volts
	V_{GT2}	1.5	
	V_{GT3}	1.5	
Latching Current ($V_D = 12\text{V}$, $I_G = 5\text{mA}$)	I_{L1}	15	mA
	I_{L2}	20	
	I_{L3}	15	
Holding current ($V_D = 12\text{V}$, initiation current = $\pm 200\text{mA}$, gate open)	I_H	10	mA

DYNAMIC CHARACTERISTICS

PARAMETER	SYMBOL	MIN	UNIT
Critical Rate of Rise of Off-State Voltage ($V_D = 67\%$ Rated V_{DRM} , Exponential Waveform, gate open, $T_J = +110^\circ\text{C}$)	dv/dt	15	V/us

RATING AND CHARACTERISTIC CURVES
T12M5T600B(LS)

Symbol	Parameter
V_{DRM}	Peak Repetitive Forward Off State Voltage
I_{DRM}	Peak Forward Blocking Current
V_{RRM}	Peak Repetitive Reverse Off State Voltage
I_{RRM}	Peak Reverse Blocking Current
V_{TM}	Maximum On State Voltage
I_H	Holding Current

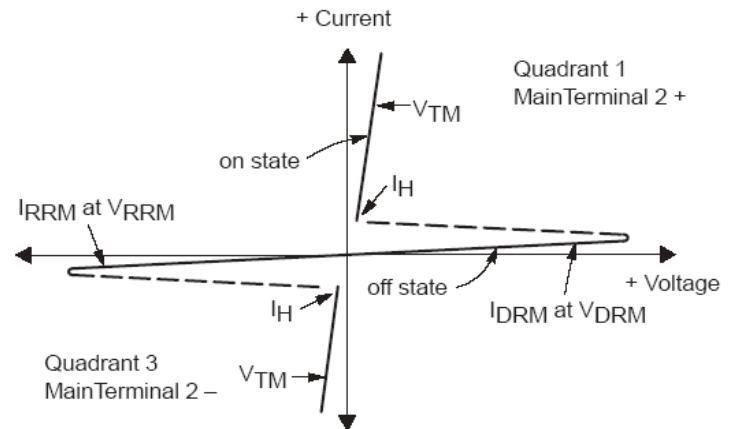

Quadrant Definitions

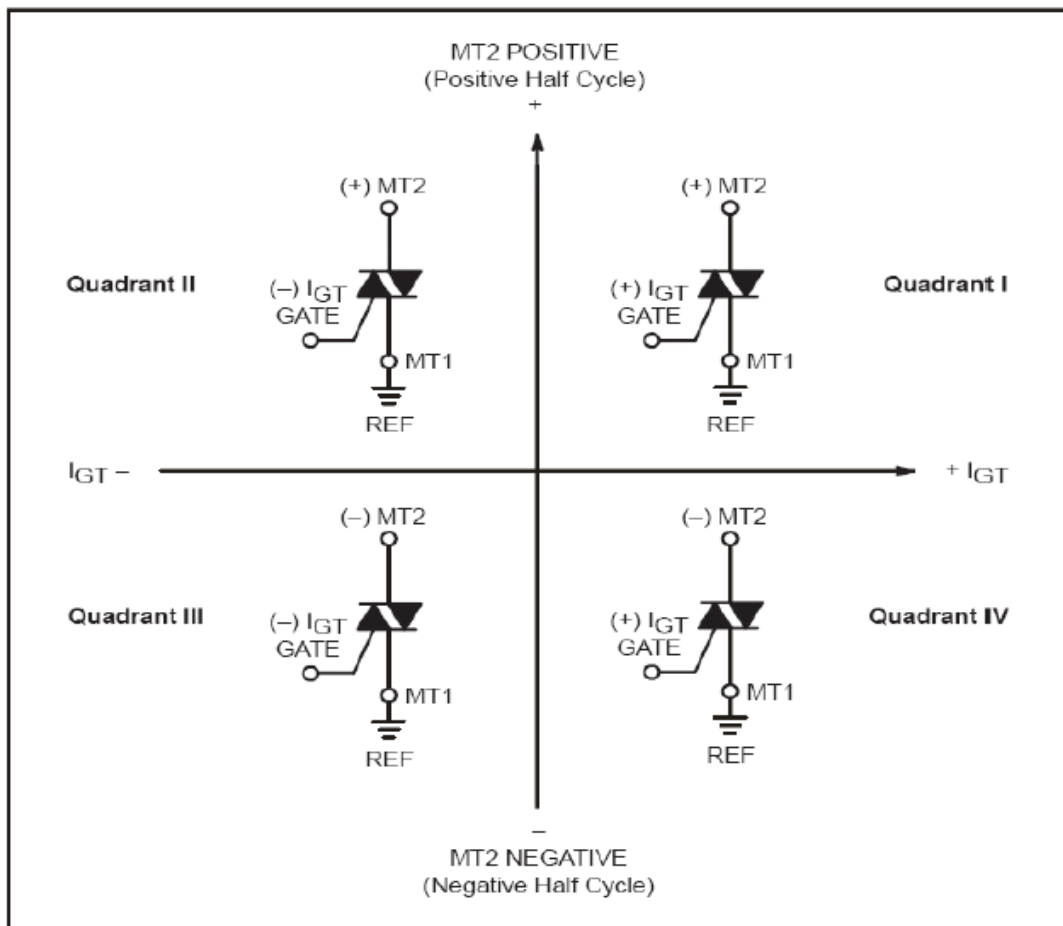

All polarities are referenced to MT1

Which in -phase signal (using standard AC lines) quadrants I and III are used

RATING AND CHARACTERISTIC CURVES
T12M5T600B(LS)

Figure 1. Typical Gate Trigger Current versus Junction Temperature

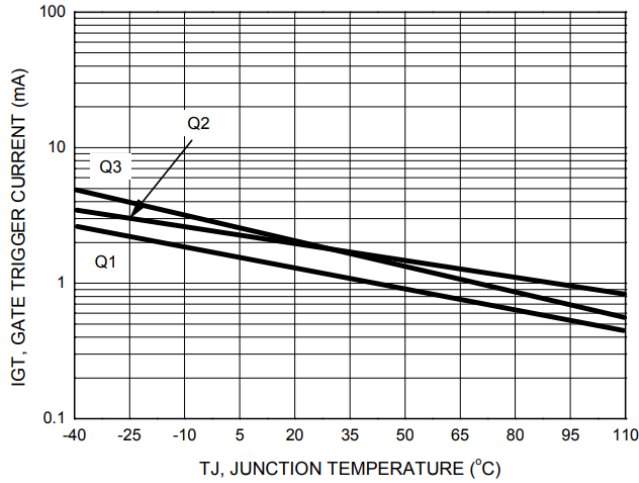

Figure 2. Typical Gate Trigger Voltage versus Junction Temperature

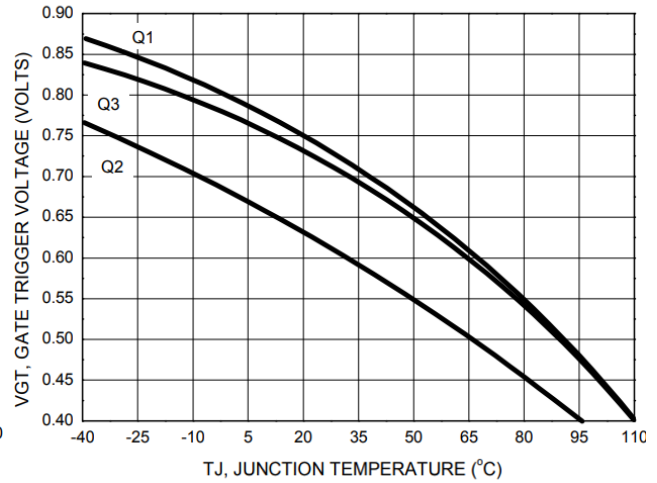

Figure 3. Typical Latching Current versus Junction Temperature

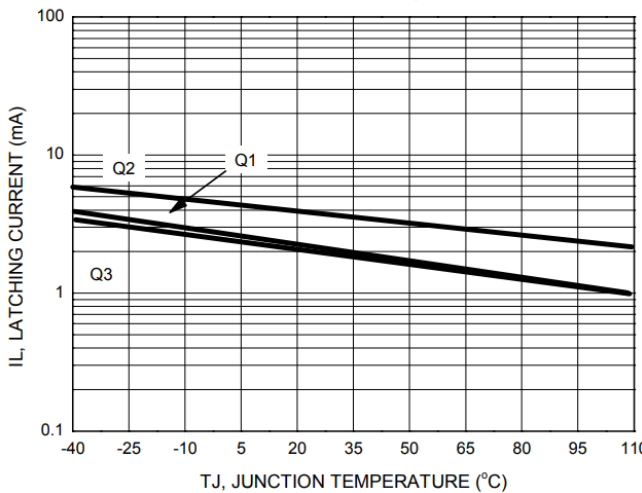

Figure 4. Typical Holding Current versus Junction Temperature

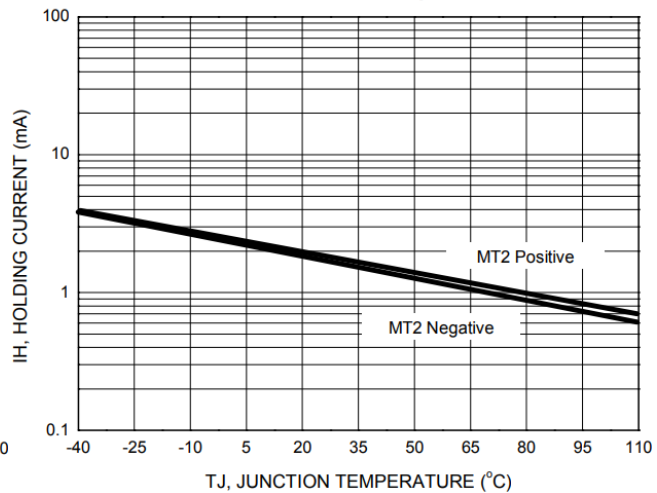

Figure 5. Typical RMS Current Derating

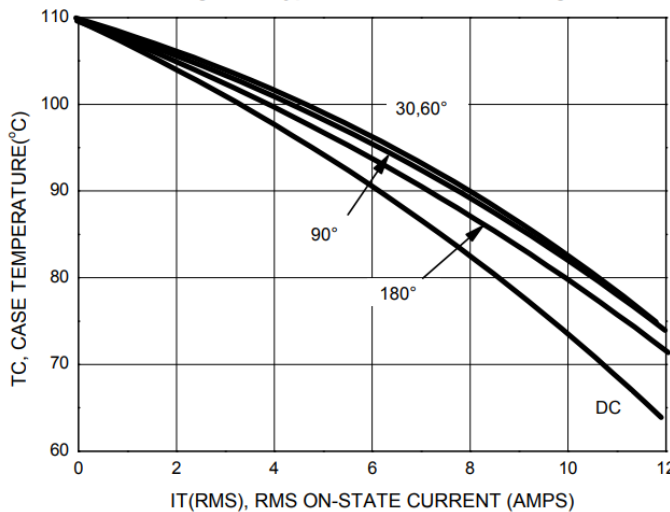
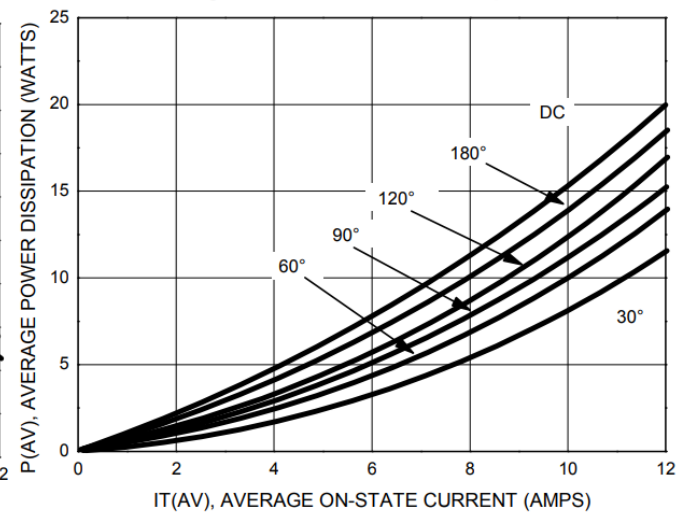

Figure 6. On-State Power Dissipation



RATING AND CHARACTERISTIC CURVES
T12M5T600B(LS)

Figure 7. Typical On-State Characteristics

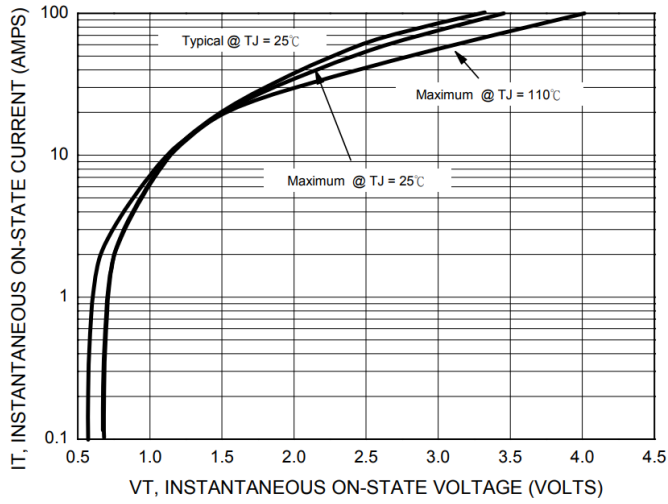
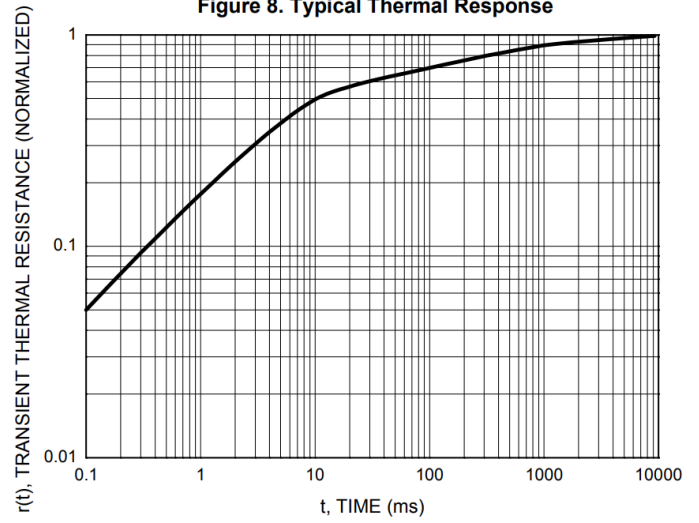

Figure 8. Typical Thermal Response



Ordering Information:

Part Number	Package	Packing	
		Qty.	Carrier
T12M5T600B	TO-220AB	50pcs	Tube

Marking Information:

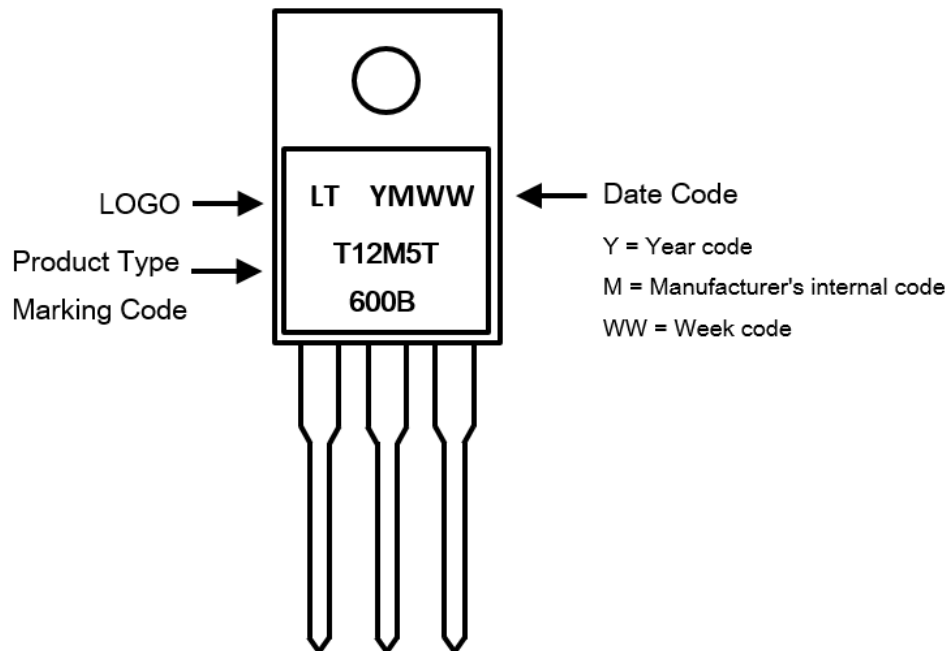

IMPORTANT NOTICE

1. DIODES INCORPORATED (Diodes) AND ITS SUBSIDIARIES MAKE NO WARRANTY OF ANY KIND, EXPRESS OR IMPLIED, WITH REGARDS TO ANY INFORMATION CONTAINED IN THIS DOCUMENT, INCLUDING, BUT NOT LIMITED TO, THE IMPLIED WARRANTIES OF MERCHANTABILITY, FITNESS FOR A PARTICULAR PURPOSE OR NON-INFRINGEMENT OF THIRD PARTY INTELLECTUAL PROPERTY RIGHTS (AND THEIR EQUIVALENTS UNDER THE LAWS OF ANY JURISDICTION).
2. The Information contained herein is for informational purpose only and is provided only to illustrate the operation of Diodes' products described herein and application examples. Diodes does not assume any liability arising out of the application or use of this document or any product described herein. This document is intended for skilled and technically trained engineering customers and users who design with Diodes' products. Diodes' products may be used to facilitate safety-related applications; however, in all instances customers and users are responsible for (a) selecting the appropriate Diodes products for their applications, (b) evaluating the suitability of Diodes' products for their intended applications, (c) ensuring their applications, which incorporate Diodes' products, comply the applicable legal and regulatory requirements as well as safety and functional-safety related standards, and (d) ensuring they design with appropriate safeguards (including testing, validation, quality control techniques, redundancy, malfunction prevention, and appropriate treatment for aging degradation) to minimize the risks associated with their applications.
3. Diodes assumes no liability for any application-related information, support, assistance or feedback that may be provided by Diodes from time to time. Any customer or user of this document or products described herein will assume all risks and liabilities associated with such use, and will hold Diodes and all companies whose products are represented herein or on Diodes' websites, harmless against all damages and liabilities.
4. Products described herein may be covered by one or more United States, international or foreign patents and pending patent applications. Product names and markings noted herein may also be covered by one or more United States, international or foreign trademarks and trademark applications. Diodes does not convey any license under any of its intellectual property rights or the rights of any third parties (including third parties whose products and services may be described in this document or on Diodes' website) under this document.
5. Diodes' products are provided subject to Diodes' Standard Terms and Conditions of Sale (<https://www.diodes.com/about/company/terms-and-conditions/terms-and-conditions-of-sales/>) or other applicable terms. This document does not alter or expand the applicable warranties provided by Diodes. Diodes does not warrant or accept any liability whatsoever in respect of any products purchased through unauthorized sales channel.
6. Diodes' products and technology may not be used for or incorporated into any products or systems whose manufacture, use or sale is prohibited under any applicable laws and regulations. Should customers or users use Diodes' products in contravention of any applicable laws or regulations, or for any unintended or unauthorized application, customers and users will (a) be solely responsible for any damages, losses or penalties arising in connection therewith or as a result thereof, and (b) indemnify and hold Diodes and its representatives and agents harmless against any and all claims, damages, expenses, and attorney fees arising out of, directly or indirectly, any claim relating to any noncompliance with the applicable laws and regulations, as well as any unintended or unauthorized application.
7. While efforts have been made to ensure the information contained in this document is accurate, complete and current, it may contain technical inaccuracies, omissions and typographical errors. Diodes does not warrant that information contained in this document is error-free and Diodes is under no obligation to update or otherwise correct this information. Notwithstanding the foregoing, Diodes reserves the right to make modifications, enhancements, improvements, corrections or other changes without further notice to this document and any product described herein. This document is written in English but may be translated into multiple languages for reference. Only the English version of this document is the final and determinative format released by Diodes.
8. Any unauthorized copying, modification, distribution, transmission, display or other use of this document (or any portion hereof) is prohibited. Diodes assumes no responsibility for any losses incurred by the customers or users or any third parties arising from any such unauthorized use.
9. This Notice may be periodically updated with the most recent version available at <https://www.diodes.com/about/company/terms-and-conditions/important-notice>

The Diodes logo is a registered trademark of Diodes Incorporated in the United States and other countries.
All other trademarks are the property of their respective owners.
© 2023 Diodes Incorporated. All Rights Reserved.

www.diodes.com