

Features

- Output Current: 300mA or more
- Dropout Voltage: 270mV @ 300mA for 3.3V
- Operating Voltage Range: 1.8V to 5.5V
- Output Voltage Range: 1.2V to 3.3V (100mV Step)
- Low Power Consumption: 65µA
- Standby Current: 0.1µA
- High Ripple Rejection: 75dB @ 1kHz
- Output Current-Limit Protection
- Thermal Shutdown Protection
- Auto Output Discharge
- Operating Temperature Range: -40 ° C to +85 ° C
- Low ESR Capacitor Compatible: Ceramic Capacitor
- Lead Free and Green Package: UDFN-6L 1x1

Description

The PT7M8208 series are highly accurate, low dropout voltage regulators with low noise, high ripple rejection and low current consumption. The PT7M8208 includes a reference voltage source, an error amplifier, a driver transistor, a current limit protection, a thermal protection and an internal phase compensator. The output voltage for the regulator is set by factory trimming within a range of 1.2V to 3.3V in 100mV step includes 2.85V. The PT7M8208 series are stable with low ESR ceramic capacitors.

Pin Configuration

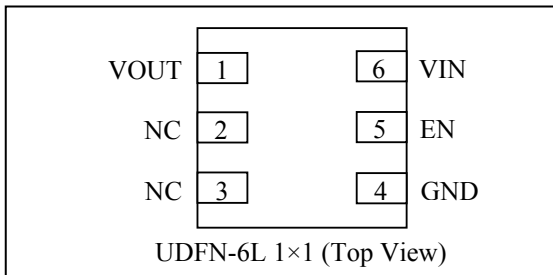

Applications

- Mobile phones (PDC, GSM, CDMA, IMT2000 etc.)
- Cordless phones and radio communication
- Digital still cameras and video cameras
- PDAs
- MP3 players
- Portable devices

Pin Description

Pin No.	I/O	Name	Descriptions
1	O	VOUT	Output of Regulator. Bypass with a 1µF ceramic capacitor (X5R/X7R) to GND.
2, 3	-	NC	No Connect ion.
4	P	GND	Ground.
5	I	EN	ON/OFF Control of Regulator.
6	I	VIN	Regulator Supply Input. Supply voltage can range from 1.8V to 5.5V. Bypass with a 1µF ceramic capacitor (X5R/X7R) to GND.

Maximum Ratings

Storage Temperature.....	-55 to +125
Ambient Temperature with Power Applied.....	-40 to +85
Input Voltage.....	+6.0V
Output Voltage	-0.3 to V _{CC} +0.3V
EN pin Voltage.....	+6.0V
DC Input/Output Current	700mA
Power Dissipation.....	UDFN/400mW

Note:

Stresses greater than those listed under MAXIMUM RATINGS may cause permanent damage to the device. This is a stress rating only and functional operation of the device at these or any other conditions above those indicated in the operational sections of this specification is not implied. Exposure to absolute maximum rating conditions for extended periods may affect reliability.

Recommended Operating Conditions

Symbol	Parameter	Min.	Typ.	Max.	Unit
V _{CC}	Operating Voltage	1.8	-	5.5	V
T _A	Operating temperature	-40	25	85	°C

Electrical Characteristics (T_A=25 , Bypass capacitor=22nF)

Parameter	Symbol	Conditions	Min.	Typ.	Max.	Unit	
Output Voltage	V _{OUT(E)} *2	V _{IN} =V _{OUT(S)} *1+1.0V, I _{OUT} =30mA	V _{OUT(S)} *0.98	V _{OUT(S)}	V _{OUT(S)} *1.02	V	
Maximum Output Current	I _{OUTMAX}	V _{IN} =V _{OUT(S)} +1.0V	300	-	-	mA	
Dropout Voltage	V _{dif} *3	I _{OUT} = 300mA	1.7V ≤ V _{OUT(S)} ≤ 1.8V	-	0.39	0.51	V
			1.9V ≤ V _{OUT(S)} ≤ 2.3V	-	0.33	0.43	
			2.4V ≤ V _{OUT(S)} ≤ 2.7V	-	0.30	0.39	
			2.8V ≤ V _{OUT(S)} ≤ 3.3V	-	0.27	0.35	
Supply Current	I _{SS}	V _{IN} = V _{OUT(S)} + 1.0V, no load	-	65	100	μA	
Standby Current	I _{SB}	V _{IN} = V _{OUT(S)} +1.0V EN=OFF	-	0.1	1	μA	
Line Regulation	$\frac{\Delta V_{OUT}}{\Delta V_{IN}} * V_{OUT}$	V _{OUT(S)} +1.0V ≤ V _{IN} ≤ 5.5V I _{OUT} =30 mA	-	0.05	0.2	%/V	
Load Regulation	ΔV _{OUT2}	V _{IN} = V _{OUT(S)} +1.0V, 1.0mA ≤ I _{OUT} ≤ 300mA	-	-	0.6	%	
Input Voltage	V _{IN}	-	1.8	-	5.5	V	
Output Voltage Temperature Characteristic	$\frac{\Delta V_{OUT}}{\Delta T_{opr}} * V_{OUT}$	I _{OUT} =30 mA -40 ≤ T _{opr} ≤ 85	-	+/-100	-	ppm/	
Ripple Rejection	PSRR	V _{IN} =[V _{OUT(S)} +1.0]V _{DC} +1Vp-p AC V _{OUT} =1.5V, I _{OUT} =30mA, f=1kHz	-	75	-	dB	
Current Limit	I _{LIM}	V _{OUT} = V _{OUT(S)} *0.9	400	450	600	mA	
Thermal Shutdown	T _{SD}			170			
Thermal Shutdown Hysteresis	ΔT _{SD}			40			
EN"High"Voltage	V _{ENH}	-	1.5	-	-	V	
EN"Low"Voltage	V _{ENL}	-	-	-	0.3		
EN"High"Current	I _{ENH}	V _{IN} =V _{OUT(S)} +1.0V	-0.10	-	0.10	μA	
EN"Low" Current	I _{ENL}	V _{IN} = V _{OUT(S)} +1.0V, EN=OFF	-0.10	-	0.10		
Output Discharge Resistance	R _{dis}	V _{IN} = V _{OUT(S)} +1.0V EN=OFF	-	200	-	Ω	

Note:

*1: V_{OUT(S)}=Specified output voltage.

*2: V_{OUT(E)}=Effective output voltage.

(I.e. the output voltage when "V_{OUT(S)}+1.0V" is provided at the VIN pin while maintaining a certain I_{OUT} value).

*3: V_{dif}={V_{IN1}(*5)-V_{OUT1}(*4)}.

*4: V_{OUT1}=A voltage equal to 98% of the output voltage whenever an amply stabilized I_{OUT} {V_{OUT(S)} + 1.0V} is input.

*5: V_{IN1}=The input voltage when V_{OUT1} appears as input voltage is gradually decreased.

*6: Unless otherwise stated, V_{IN}=V_{OUT(S)}+1.0V

Typical Performance and Characteristics

1. Output Voltage vs. Output Current

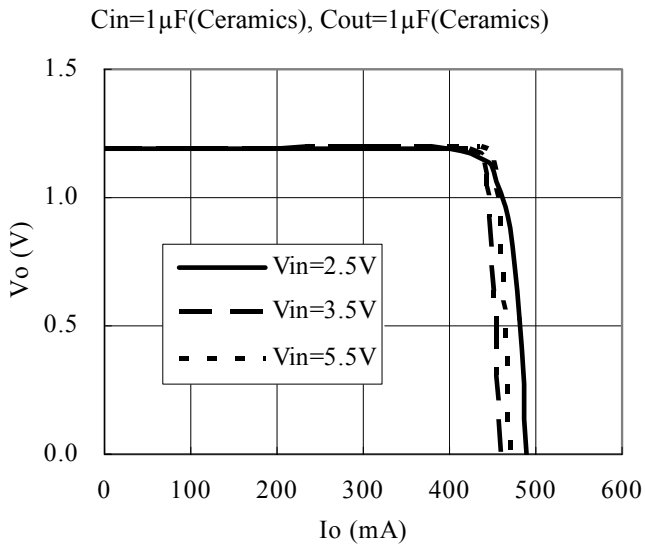
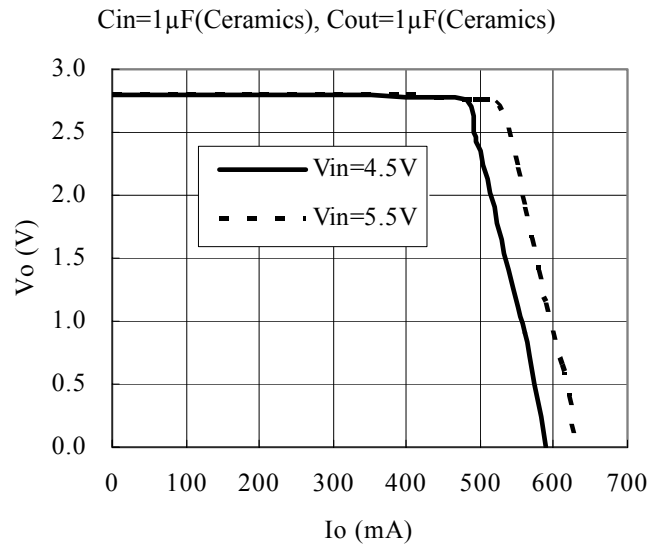
PT7M8208 (1.2V)

PT7M8208 (3.3V)

2. Output Voltage vs. Input Voltage

PT7M8208 (1.2V)

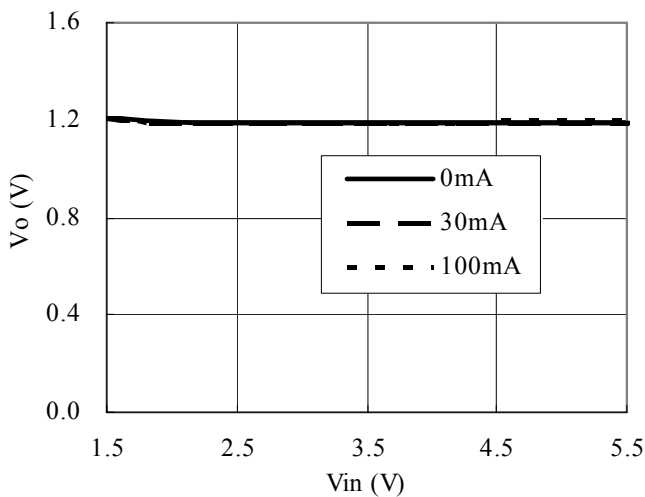
Topr=25

 Cin=1 μ F(Ceramics), Cout=1 μ F(Ceramics)

PT7M8208 (3.3V)

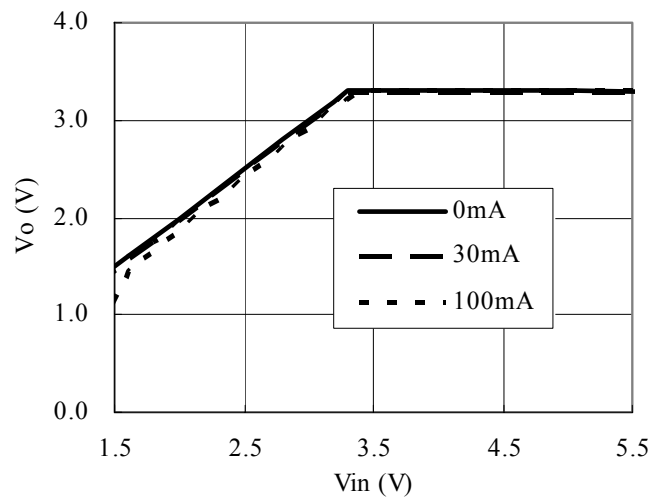
Topr=25

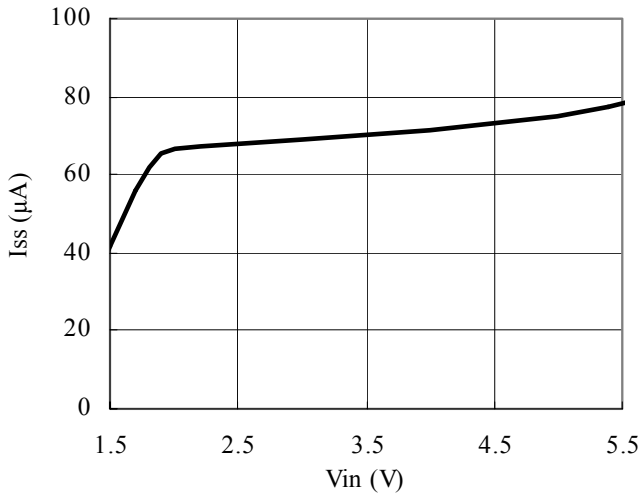
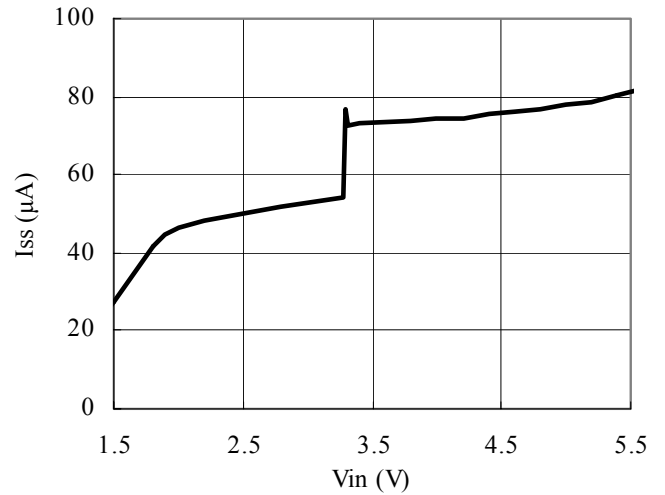
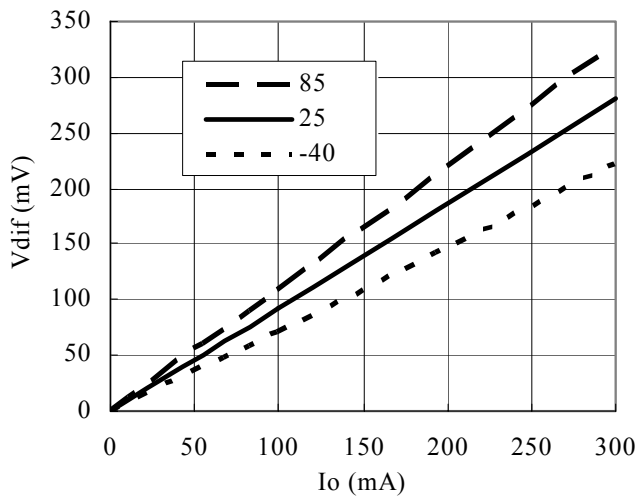
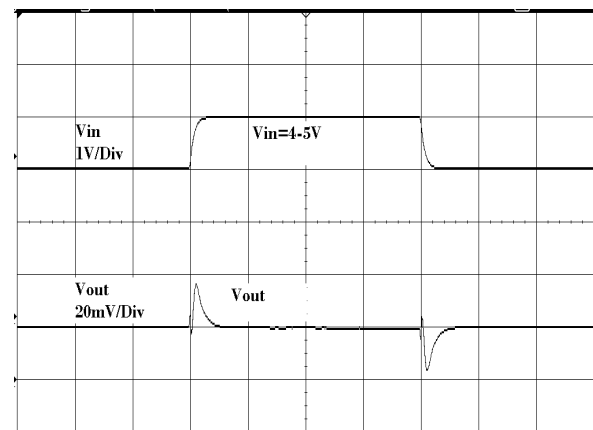
 Cin=1 μ F(Ceramics), Cout=1 μ F(Ceramics)

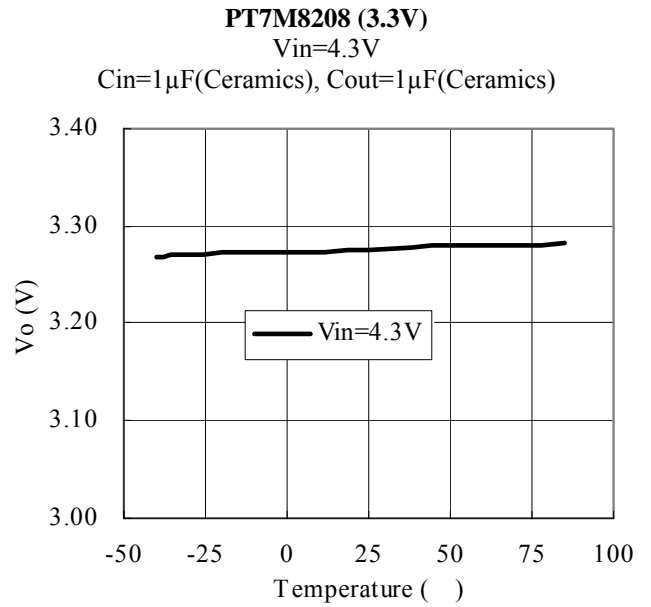
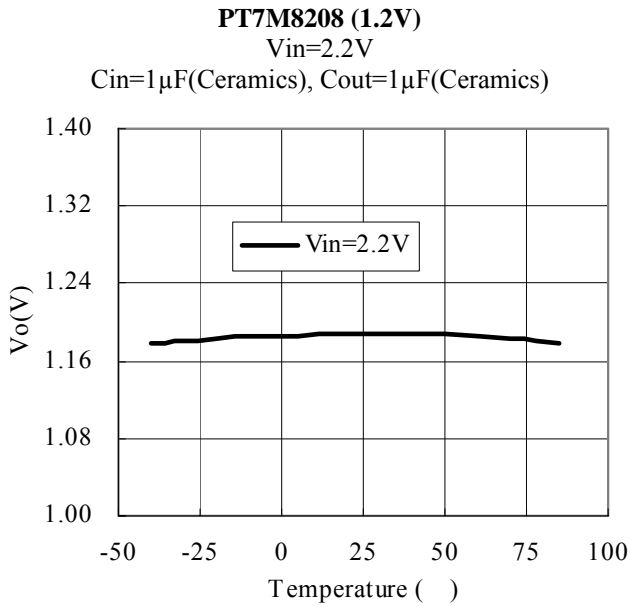
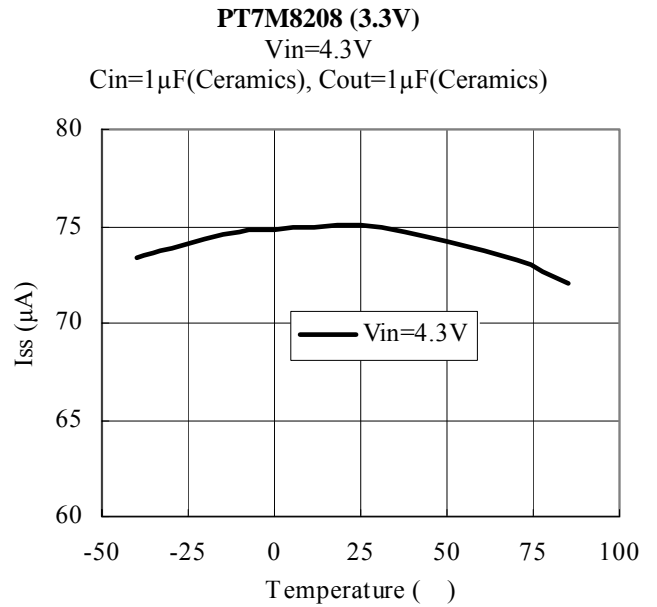
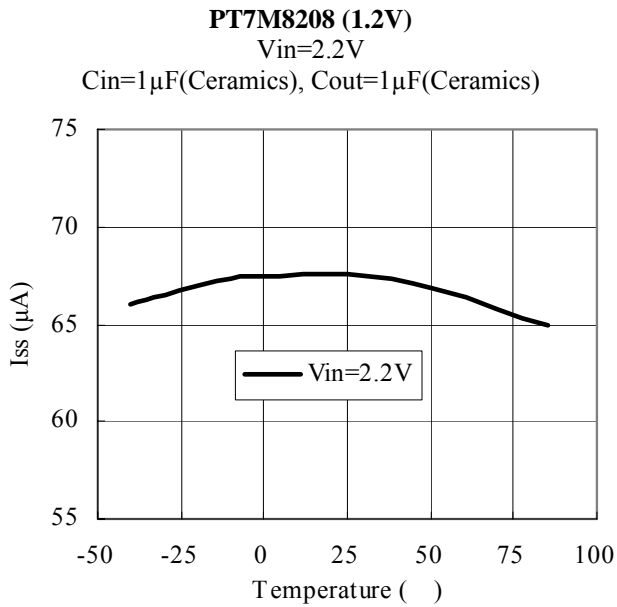
3. Supply Current vs. Input Voltage
PT7M8208 (1.2V)

PT7M8208 (3.3V)

4. Dropout Voltage vs. Output Current
PT7M8208 (3.3V)
 $C_{in}=1\mu F$ (Ceramics), $C_{out}=1\mu F$ (Ceramics)

5. Line Transient Response
PT7M8208 (3.3V)
 $C_{in}=C_{out}=1\mu F$ (Ceramics), $I_{out}=100mA$
 Time (50 μs /Div)

6. Output Voltage vs. Ambient Temperature

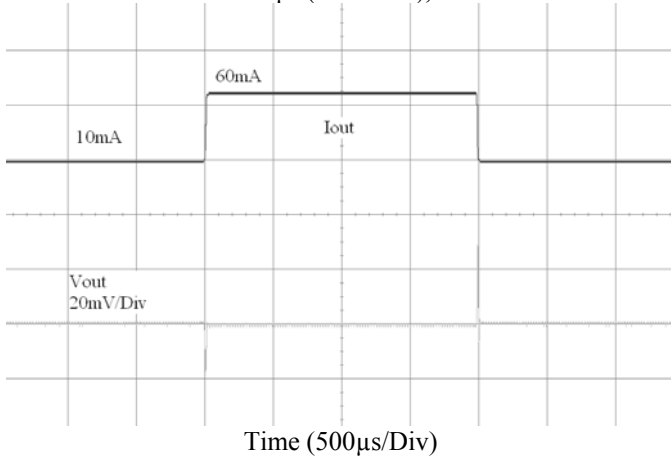
7. Supply Current vs. Ambient Temperature

8. Load Transient Response

PT7M8208 (3.3V)

Cin= Cout=1 μ F(Ceramics), Vin=4.3V



PT7M8208 (3.3V)

Cin= Cout=1 μ F(Ceramics), Vin=4.3V

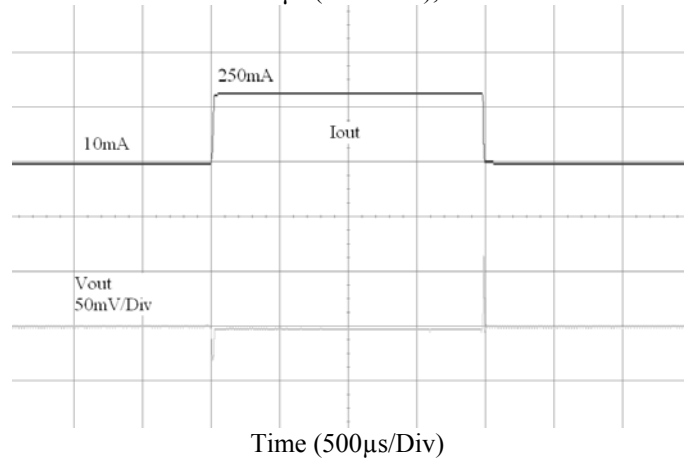

Function block diagram

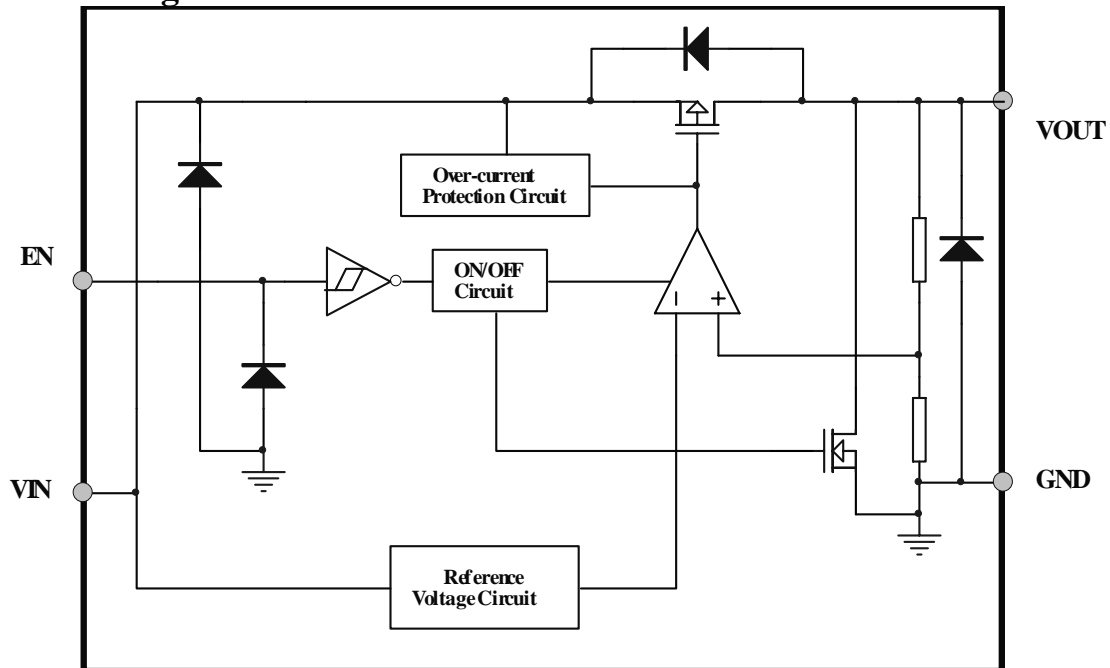

Functional Description *(Refer to Function Block Diagram)*

Output Voltage

The divided output voltage is compared with the internal reference voltage by the error amplifier with internal phase compensator. The output of the error amplifier then drives the P-channel MOSFET to maintain a stable and constant output voltage.

Low ESR Capacitors

The internal phase compensator maintains the stable output voltage with low ESR ceramic input and output capacitors. 1 μ F low ESR (X5R/X7R) ceramic capacitor located as close as possible to the IC's pins is recommended.

Current Limit and Thermal Shutdown Protections

Current limit protection is used to limit the output current when an overload condition occurs. As a result, the output voltage will drop. Thermal shutdown protection will turn off the output to reduce the power dissipation when the operation junction temperature exceeds 170°C.

EN Pin

The output of the regulator in PT7M8208 can be controlled with EN pin. The EN pin should be connected to a "VIN" or a "GND" voltage as a floating input applied to inverter input of the enable circuitry will increase the current consumption.

■ NOTE ON USE

1. Please use this IC within the stated absolute maximum ratings.
2. Where wiring impedance is high, operations may become unstable due to noise and/or phase lag depending on output current. Please keep the resistance low between VIN and GND wiring in particular.
3. Please wire the input capacitor (C_{in}) and the output capacitor (C_{out}) as close to the IC as possible.

Application Circuit

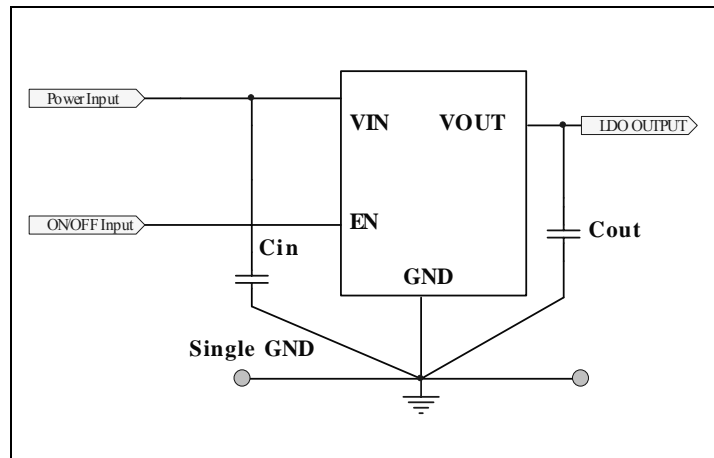

Note: $C_{in}=C_{out}=1\mu F$

Mechanical Information

ZUE(Lead free and Green UDFN-6L 1x1)

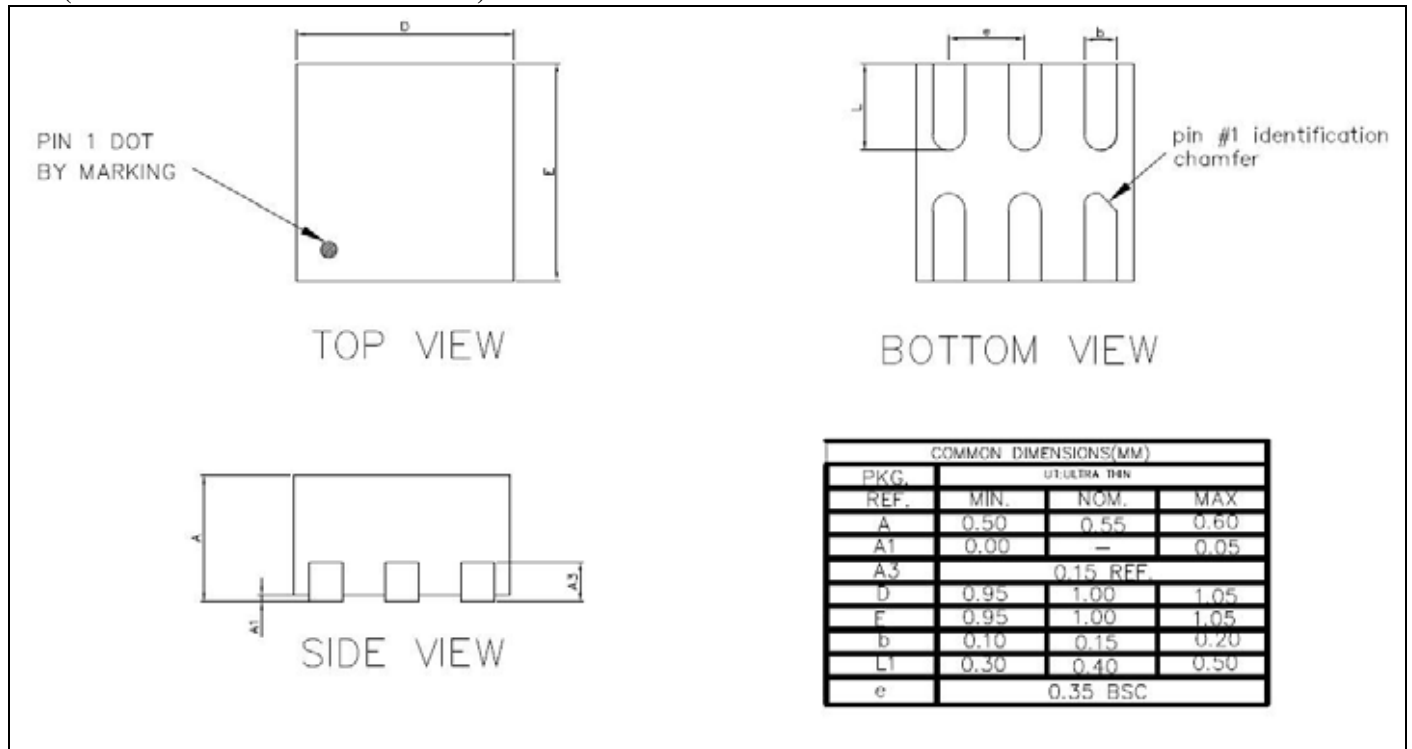

Marking Description

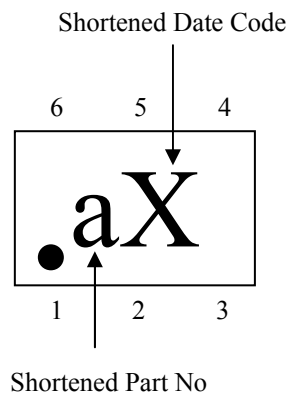

Part No	Shortened Part No	Part No	Shortened Part No
PT7M8208B28	a	PT7M8208B33	d
PT7M8208B18	c	PT7M8208B12	f

Ordering Information

Part Number	Package Code	Package
PT7M8208 ZUE	ZU	Lead free and Green UDFN-6L 1x1

Notes:

- “ ” refer to different functions. See below Table 1 and Table 2.
- E = Pb-free and Green
- Adding X Suffix= Tape/Reel

Table 1 Option Definition Table

Designator	Symbol	Description
Regulators EN type	A	Low active
	B	High active
Regulator Output voltage	12-33, 2A	Internally set sequential number relating output voltage of regulator , the detail is in Table 2

Table 2 Definition of designator

Designator	VOUT (V)	Designator	VOUT (V)	Designator	VOUT (V)
12	1.2	20	2.0	28	2.8
13	1.3	21	2.1	29	2.9
14	1.4	22	2.2	30	3.0
15	1.5	23	2.3	31	3.1
16	1.6	24	2.4	32	3.2
17	1.7	25	2.5	33	3.3
18	1.8	26	2.6	2A	2.85
19	1.9	27	2.7		