

Product Summary

$V_{(BR)DSS}$	$R_{DS(ON)}$ Max	I_D Max $T_A = +25^\circ\text{C}$
60V	8Ω @ $V_{GS} = 5V$	170mA
	6Ω @ $V_{GS} = 10V$	200mA

Features and Benefits

- Dual N-Channel MOSFET
- Low On-Resistance
- Low Gate Threshold Voltage
- Low Input Capacitance
- Fast Switching Speed
- Small Surface Mount Package
- ESD Protected Gate, 1kV (HBM)
- **Totally Lead-Free & Fully RoHS Compliant (Notes 1 & 2)**
- **Halogen and Antimony Free. "Green" Device (Note 3)**
- **For automotive applications requiring specific change control (i.e.: parts qualified to AEC-Q100/101/200, PPAP capable, and manufactured in IATF 16949 certified facilities), please refer to the related automotive grade (Q-suffix) part. A listing can be found at <https://www.diodes.com/products/automotive/automotive-products/>.**
- **This part is qualified to JEDEC standards (as references in AEC-Q) for High Reliability. <https://www.diodes.com/quality/product-definitions/>**
- **An Automotive-Compliant Part is Available Under Separate Datasheet ([DMN65D8LDWQ](#))**

Description and Applications

This new generation MOSFET is designed to minimize the on-state resistance ($R_{DS(ON)}$) and yet maintain superior switching performance, making it ideal for high efficiency power management applications.

- DC-DC Converters
- Power Management Functions
- Battery Operated Systems and Solid-State Relays
- Drivers: Relays, Solenoids, Lamps, Hammers, Displays, Memories, Transistors, etc.

Mechanical Data

- Case: SOT363
- Case Material: Molded Plastic; UL Flammability Classification Rating 94V-0
- Moisture Sensitivity: Level 1 per J-STD-020
- Terminals: Solderable per MIL-STD-202, Method 208^{e3}
- Lead Free Plating (Matte Tin Finish Annealed over Alloy 42 Lead-Frame).
- Terminal Connections: See Diagram
- Weight: 0.006 grams (Approximate)



SOT363



Top View

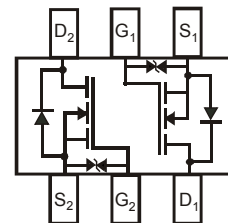

Top View
Internal Schematic

Ordering Information (Note 4)

Part Number	Case	Packaging
DMN65D8LDW-7	SOT363	3,000/Tape & Reel

- Notes:
1. No purposely added lead. Fully EU Directive 2002/95/EC (RoHS), 2011/65/EU (RoHS 2) & 2015/863/EU (RoHS 3) compliant.
 2. See <https://www.diodes.com/quality/lead-free/> for more information about Diodes Incorporated's definitions of Halogen- and Antimony-free, "Green" and Lead-free.
 3. Halogen- and Antimony-free "Green" products are defined as those which contain <900ppm bromine, <900ppm chlorine (<1500ppm total Br + Cl) and <1000ppm antimony compounds.
 4. For packaging details, go to our website at <https://www.diodes.com/design/support/packaging/diodes-packaging/>.

Marking Information

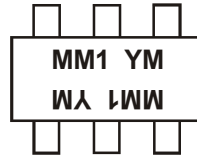

MM1= Product Type Marking Code
 YM = Date Code Marking
 Y or \bar{Y} = Year (ex: H = 2020)
 M or \bar{M} = Month (ex: 9 = September)

Date Code Key

Year	2007	~	2020	2021	2022	2023	2024	2025	2026	2027	2028	2029
Code	U	~	H	I	J	K	L	M	N	O	P	R

Month	Jan	Feb	Mar	Apr	May	Jun	Jul	Aug	Sep	Oct	Nov	Dec
Code	1	2	3	4	5	6	7	8	9	O	N	D

Maximum Ratings (@ $T_A = +25^\circ\text{C}$, unless otherwise specified.)

Characteristic				Symbol	Value	Units
Drain-Source Voltage				V_{DSS}	60	V
Gate-Source Voltage				V_{GSS}	± 20	V
Continuous Drain Current (Note 5)	$V_{GS} = 10\text{V}$	Steady State	$T_A = +25^\circ\text{C}$ $T_A = +70^\circ\text{C}$	I_D	180 140	mA
Continuous Drain Current (Note 5)	$V_{GS} = 5\text{V}$	Steady State	$T_A = +25^\circ\text{C}$ $T_A = +70^\circ\text{C}$	I_D	150 120	mA
Continuous Drain Current (Note 6)	$V_{GS} = 10\text{V}$	Steady State	$T_A = +25^\circ\text{C}$ $T_A = +70^\circ\text{C}$	I_D	200 160	mA
Continuous Drain Current (Note 6)	$V_{GS} = 5\text{V}$	Steady State	$T_A = +25^\circ\text{C}$ $T_A = +70^\circ\text{C}$	I_D	170 140	mA
Pulsed Drain Current (10 μs pulse, duty cycle = 1%)				I_{DM}	800	mA

Thermal Characteristics

Characteristic	Symbol	Value	Units
Total Power Dissipation (Note 5)	P_D	300	mW
Thermal Resistance, Junction to Ambient (Note 5)	$R_{\theta JA}$	435	$^\circ\text{C/W}$
Total Power Dissipation (Note 6)	P_D	400	mW
Thermal Resistance, Junction to Ambient (Note 6)	$R_{\theta JA}$	330	$^\circ\text{C/W}$
Thermal Resistance, Junction to Case (Note 6)	$R_{\theta JC}$	139	$^\circ\text{C/W}$
Operating and Storage Temperature Range	T_J, T_{STG}	-55 to +150	$^\circ\text{C}$

Electrical Characteristics (@ $T_A = +25^\circ\text{C}$, unless otherwise specified.)

Characteristic	Symbol	Min	Typ	Max	Unit	Test Condition
OFF CHARACTERISTICS (Note 7)						
Drain-Source Breakdown Voltage	BV_{DSS}	60	—	—	V	$V_{GS} = 0V, I_D = 250\mu A$
Zero Gate Voltage Drain Current	I_{DSS}	—	—	1.0 5.0	μA	$T_J = +25^\circ\text{C}$ $T_J = +125^\circ\text{C}$ (Note 8) $V_{DS} = 60V, V_{GS} = 0V$
Gate-Body Leakage	I_{GSS}	—	—	± 5.0	μA	$V_{GS} = \pm 20V, V_{DS} = 0V$
ON CHARACTERISTICS (Note 7)						
Gate Threshold Voltage	$V_{GS(th)}$	1.0	—	2.0	V	$V_{DS} = V_{GS}, I_D = 250\mu A$
Static Drain-Source On-Resistance	$R_{DS(on)}$	—	2.2	8	Ω	$V_{GS} = 5V, I_D = 0.115A$
		—	2.0	6	Ω	$V_{GS} = 10V, I_D = 0.115A$
Forward Transconductance	g_{FS}	80	—	—	mS	$V_{DS} = 10V, I_D = 0.115A$
Diode Forward Voltage	V_{SD}	—	0.8	1.2	V	$V_{GS} = 0V, I_S = 115mA$
DYNAMIC CHARACTERISTICS (Note 8)						
Input Capacitance	C_{iss}	—	22.0	—	pF	$V_{DS} = 25V, V_{GS} = 0V, f = 1.0MHz$
Output Capacitance	C_{oss}	—	3.2	—		
Reverse Transfer Capacitance	C_{rss}	—	2.0	—		
Gate Resistance	R_G	—	79.9	—	Ω	$V_{DS} = 0V, V_{GS} = 0V, f = 1.0MHz$
Total Gate Charge $V_{GS} = 10V$	Q_g	—	0.87	—	nC	$V_{GS} = 10V, V_{DS} = 30V,$ $I_D = 150mA$
Total Gate Charge $V_{GS} = 4.5V$	Q_g	—	0.43	—		
Gate-Source Charge	Q_{gs}	—	0.11	—		
Gate-Drain Charge	Q_{gd}	—	0.11	—	nS	$V_{DD} = 30V, I_D = 0.115A, V_{GEN} = 10V,$ $R_{GEN} = 25\Omega$
Turn-On Delay Time	$t_{D(on)}$	—	3.3	—		
Turn-On Rise Time	t_r	—	3.2	—		
Turn-Off Delay Time	$t_{D(off)}$	—	12.0	—		
Turn-Off Fall Time	t_f	—	6.3	—		

- Notes:
5. Device mounted on FR-4 PC board, with minimum recommended pad layout, single sided.
 6. Device mounted on FR-4 substrate PC board, 2oz copper, with 1-inch square copper pad layout
 7. Short duration pulse test used to minimize self-heating effect.
 8. Guaranteed by design. Not subject to production testing.

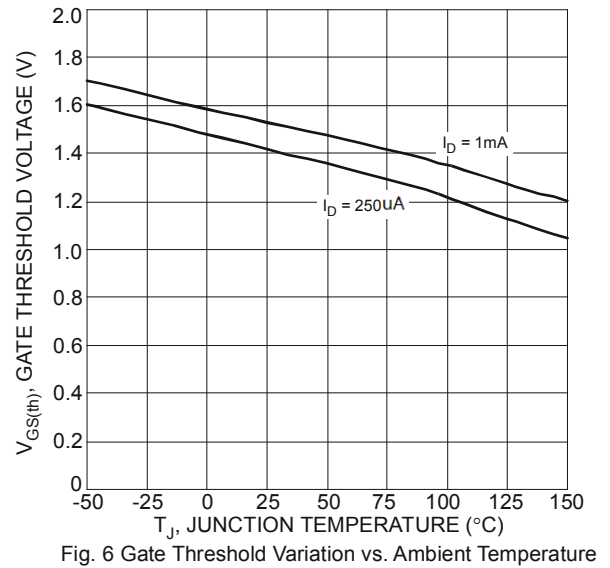
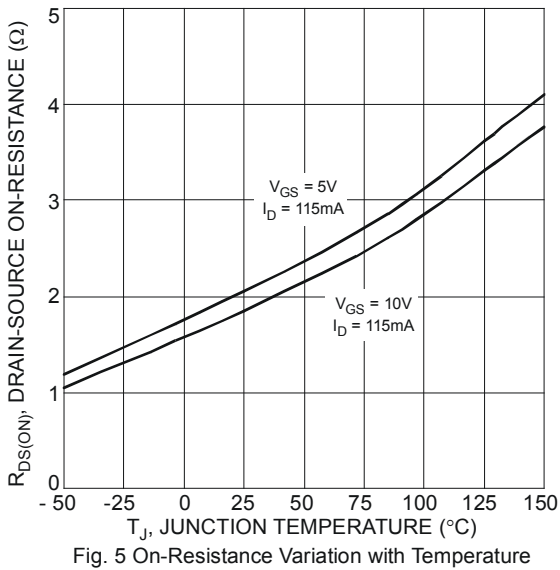
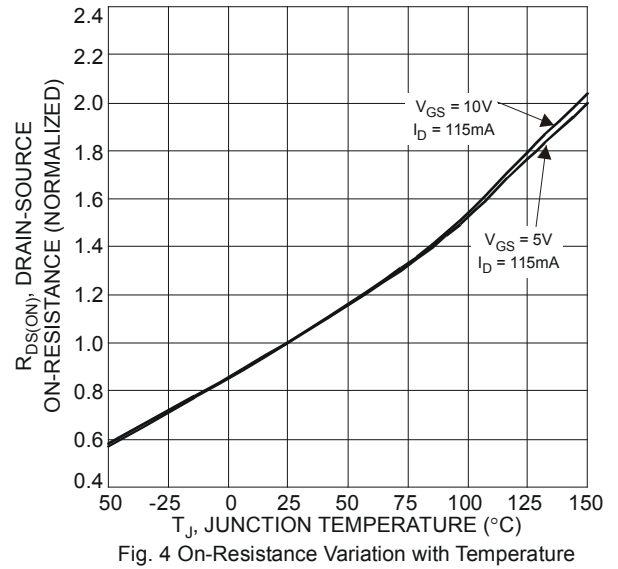
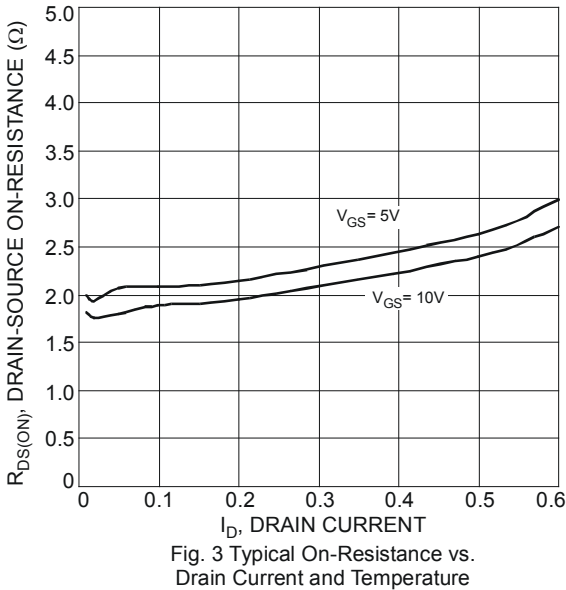
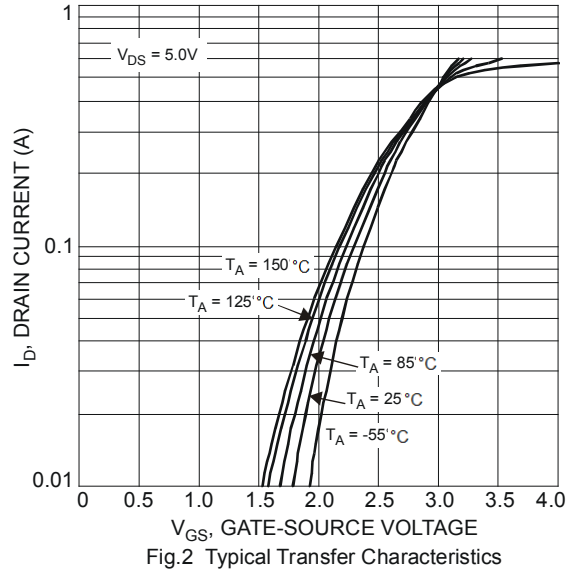
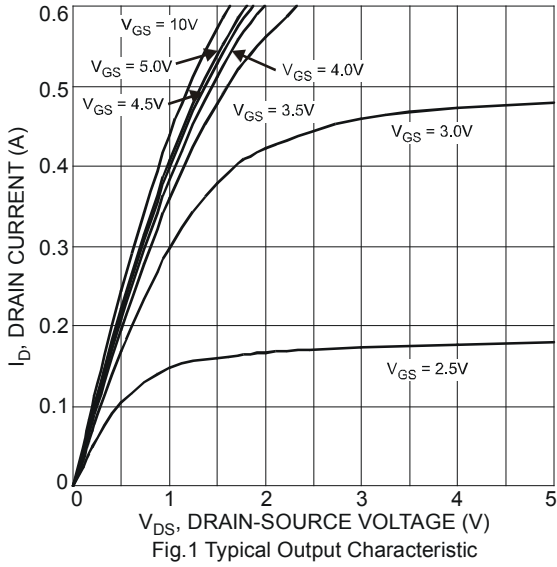

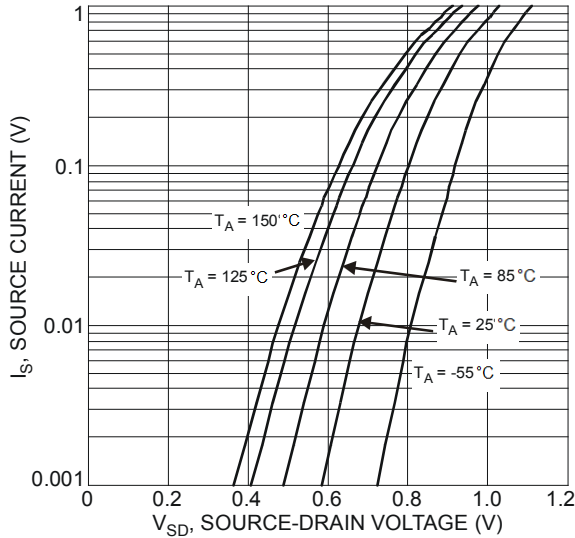

Fig. 7 Diode Forward Voltage vs. Current

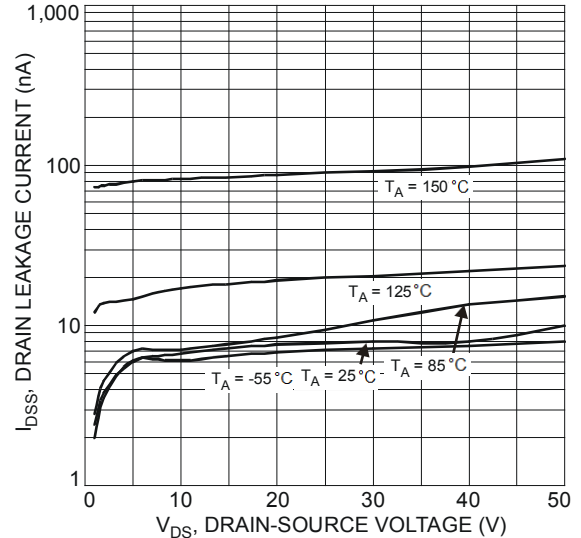

Fig. 8 Typical Drain-Source Leakage Current vs. Voltage

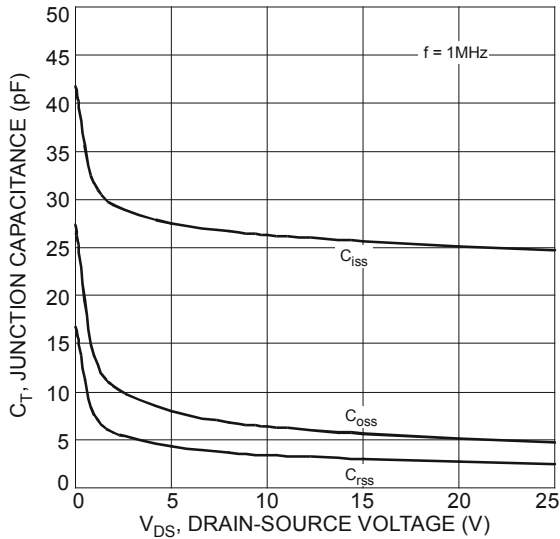

Fig. 9 Typical Junction Capacitance

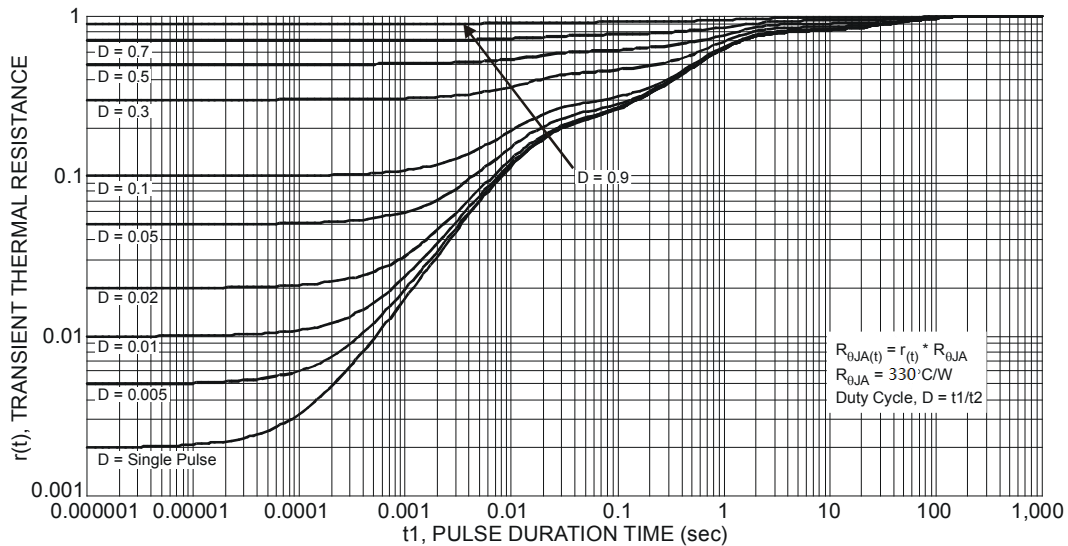

Fig. 10 Transient Thermal Resistance

$R_{\theta JA(t)} = r(t) * R_{\theta JA}$
 $R_{\theta JA} = 330^{\circ}\text{C/W}$
 Duty Cycle, $D = t1/t2$

Package Outline Dimensions

Please see <http://www.diodes.com/package-outlines.html> for the latest version.

SOT363

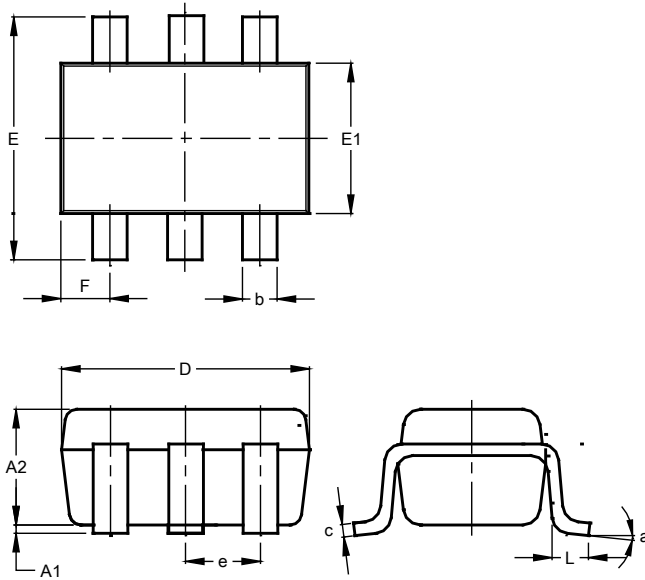

SOT363			
Dim	Min	Max	Typ
A1	0.00	0.10	0.05
A2	0.90	1.00	0.95
b	0.10	0.30	0.25
c	0.10	0.22	0.11
D	1.80	2.20	2.15
E	2.00	2.20	2.10
E1	1.15	1.35	1.30
e	0.650 BSC		
F	0.40	0.45	0.425
L	0.25	0.40	0.30
a	0°	8°	--
All Dimensions in mm			

Suggested Pad Layout

Please see <http://www.diodes.com/package-outlines.html> for the latest version.

SOT363

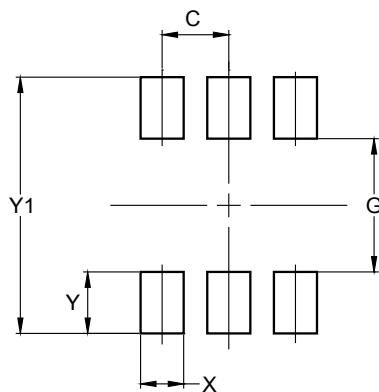

Dimensions	Value (in mm)
C	0.650
G	1.300
X	0.420
Y	0.600
Y1	2.500

IMPORTANT NOTICE

1. DIODES INCORPORATED AND ITS SUBSIDIARIES (“DIODES”) MAKE NO WARRANTY OF ANY KIND, EXPRESS OR IMPLIED, WITH REGARDS TO ANY INFORMATION CONTAINED IN THIS DOCUMENT, INCLUDING, BUT NOT LIMITED TO, THE IMPLIED WARRANTIES OF MERCHANTABILITY, FITNESS FOR A PARTICULAR PURPOSE OR NON-INFRINGEMENT OF THIRD PARTY INTELLECTUAL PROPERTY RIGHTS (AND THEIR EQUIVALENTS UNDER THE LAWS OF ANY JURISDICTION).
2. The Information contained herein is for informational purpose only and is provided only to illustrate the operation of Diodes products described herein and application examples. Diodes does not assume any liability arising out of the application or use of this document or any product described herein. This document is intended for skilled and technically trained engineering customers and users who design with Diodes products. Diodes products may be used to facilitate safety-related applications; however, in all instances customers and users are responsible for (a) selecting the appropriate Diodes products for their applications, (b) evaluating the suitability of the Diodes products for their intended applications, (c) ensuring their applications, which incorporate Diodes products, comply the applicable legal and regulatory requirements as well as safety and functional-safety related standards, and (d) ensuring they design with appropriate safeguards (including testing, validation, quality control techniques, redundancy, malfunction prevention, and appropriate treatment for aging degradation) to minimize the risks associated with their applications.
3. Diodes assumes no liability for any application-related information, support, assistance or feedback that may be provided by Diodes from time to time. Any customer or user of this document or products described herein will assume all risks and liabilities associated with such use, and will hold Diodes and all companies whose products are represented herein or on Diodes’ websites, harmless against all damages and liabilities.
4. Products described herein may be covered by one or more United States, international or foreign patents and pending patent applications. Product names and markings noted herein may also be covered by one or more United States, international or foreign trademarks and trademark applications. Diodes does not convey any license under any of its intellectual property rights or the rights of any third parties (including third parties whose products and services may be described in this document or on Diodes’ website) under this document.
5. Diodes products are provided subject to Diodes’ Standard Terms and Conditions of Sale (<https://www.diodes.com/about/company/terms-and-conditions/terms-and-conditions-of-sales/>) or other applicable terms. This document does not alter or expand the applicable warranties provided by Diodes. Diodes does not warrant or accept any liability whatsoever in respect of any products purchased through unauthorized sales channel.
6. Diodes products and technology may not be used for or incorporated into any products or systems whose manufacture, use or sale is prohibited under any applicable laws and regulations. Should customers or users use Diodes products in contravention of any applicable laws or regulations, or for any unintended or unauthorized application, customers and users will (a) be solely responsible for any damages, losses or penalties arising in connection therewith or as a result thereof, and (b) indemnify and hold Diodes and its representatives and agents harmless against any and all claims, damages, expenses, and attorney fees arising out of, directly or indirectly, any claim relating to any noncompliance with the applicable laws and regulations, as well as any unintended or unauthorized application.
7. While efforts have been made to ensure the information contained in this document is accurate, complete and current, it may contain technical inaccuracies, omissions and typographical errors. Diodes does not warrant that information contained in this document is error-free and Diodes is under no obligation to update or otherwise correct this information. Notwithstanding the foregoing, Diodes reserves the right to make modifications, enhancements, improvements, corrections or other changes without further notice to this document and any product described herein. This document is written in English but may be translated into multiple languages for reference. Only the English version of this document is the final and determinative format released by Diodes.
8. Any unauthorized copying, modification, distribution, transmission, display or other use of this document (or any portion hereof) is prohibited. Diodes assumes no responsibility for any losses incurred by the customers or users or any third parties arising from any such unauthorized use.

Copyright © 2020 Diodes Incorporated

www.diodes.com