

Description

The DML3011ALFDS load switch provides a component and area-reducing solution for efficient power domain switching. In addition to integrated control functionality with ultra-low on-resistance, this device offers system safeguards and adjustable Slew Rate control signaling. This cost effective solution is ideal for power management and hot-swap applications requiring low power consumption in a small footprint.

Applications

- Portable electronics and systems
- Notebooks and tablet computers
- Telecom, networking, medical, and industrial equipment
- Set-top boxes, servers, and gateways
- Hot-swap devices and peripheral ports

Features and Benefits

- Advanced Controller with Charge Pump
- Integrated N-Channel MOSFET with Ultra Low R_{ON}
- Input Voltage Range 0.5V to 20V
- Adjustable Soft-Start via Controlled Slew Rate
- Thermal Shutdown
- V_{CC} Undervoltage Lockout
- Short-Circuit Protection
- Extremely Low Standby Current
- Load Bleed (Quick Discharge)
- **Totally Lead-Free & Fully RoHS Compliant (Notes 1 & 2)**
- **Halogen and Antimony Free. "Green" Device (Note 3)**
- **For automotive applications requiring specific change control (i.e. parts qualified to AEC-Q100/101/104/200, PPAP capable, and manufactured in IATF 16949 certified facilities), please [contact us](mailto:contact@diodes.com) or your local Diodes representative. <https://www.diodes.com/quality/product-definitions/>**

Mechanical Data

- Package: V-DFN2020-8
- Package Material: Molded Plastic, "Green" Molding Compound. UL Flammability Classification Rating 94V-0
- Moisture Sensitivity: Level 1 per J-STD-020
- Terminals: Finish — NiPdAu over Copper Leadframe. Solderable per MIL-STD-202, Method 208 E4
- Weight: 0.011 grams (Approximate)

V-DFN2020-8 (Type N)



Top View

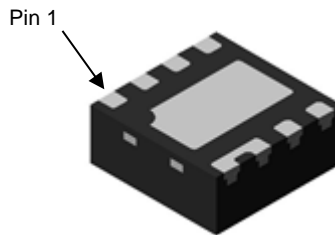

Bottom View

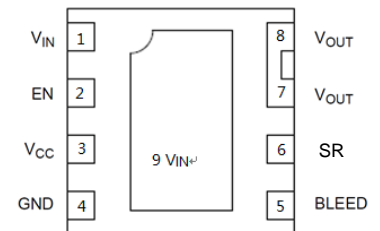

Top View

Ordering Information (Note 4)

Part Number	Package	Packing	
		Qty.	Carrier
DML3011ALFDS-7	V-DFN2020-8 (Type N)	3,000	Tape & Reel

- Notes:
1. No purposely added lead. Fully EU Directive 2002/95/EC (RoHS), 2011/65/EU (RoHS 2) & 2015/863/EU (RoHS 3) compliant.
 2. See <https://www.diodes.com/quality/lead-free/> for more information about Diodes Incorporated's definitions of Halogen- and Antimony-free, "Green" and Lead-free.
 3. Halogen- and Antimony-free "Green" products are defined as those which contain <900ppm bromine, <900ppm chlorine (<1500ppm total Br + Cl) and <1000ppm antimony compounds.
 4. For packaging details, go to our website at <https://www.diodes.com/design/support/packaging/diodes-packaging/>.

Marking Information

Site 1

V-DFN2020-8 (Type N)

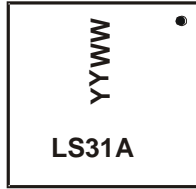

LS31A = Product Type Marking Code
 YYWW = Date Code Marking
 YY = Last Two Digits of Year (ex: 23 = 2023)
 WW = Week Code (01 to 53)

Site 2

V-DFN2020-8 (Type N)

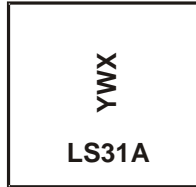

LS31A = Product Type Marking Code
 YWX = Date Code Marking
 Y = Year (ex: 3 = 2023)
 W = Week (ex: a = Week 27; z Represents Week 52 and 53)
 X = Internal Code (ex: U = Monday)

Date Code Key

Year	2023	2024	2025	2026	2027	2028	2029	2030	2031	2032	2033	2034
Code	3	4	5	6	7	8	9	0	1	2	3	4
Week	1-26				27-52				53			
Code	A-Z				a-z				z			
Internal Code	Sun	Mon	Tue	Wed	Thu	Fri	Sat					
Code	T	U	V	W	X	Y	Z					

Typical Application Circuit

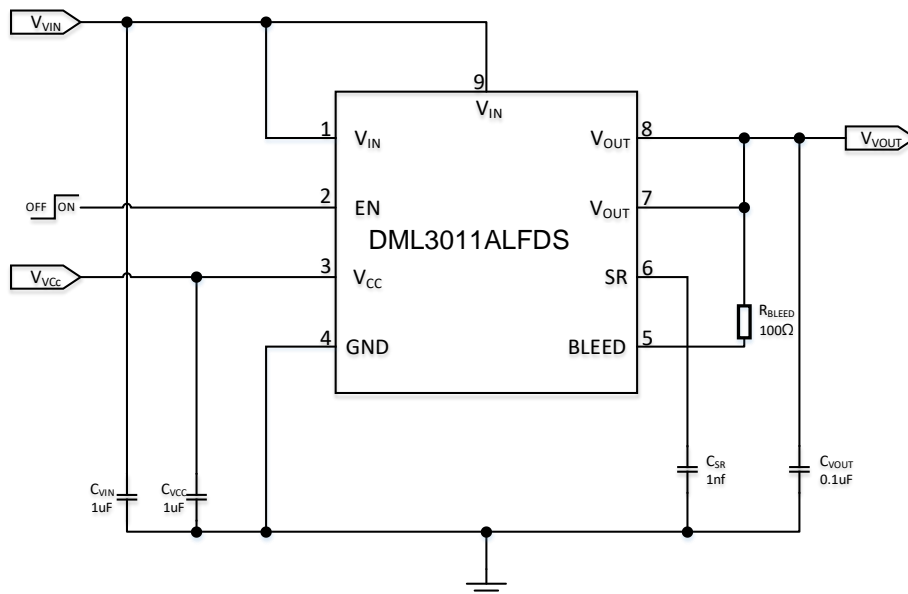

Pin Description

Pin Number	Pin Name	Pin Function
1, 9	V _{IN}	Drain of internal MOSFET, Pin 1 must connect to Pin 9.
2	EN	Active-high digital input used to turn on the MOSFET, pin has an internal pulldown resistor to GND.
3	V _{CC}	Supply voltage to controller (3.0V to 5.5V)
4	GND	Controller ground
5	BLEED	Load bleed connection, must be tied to V _{OUT} through a resistor ≤ 1kΩ.
6	SR	Slew rate adjustment
7, 8	V _{OUT}	Source of internal MOSFET connected to load

Function Block Diagram

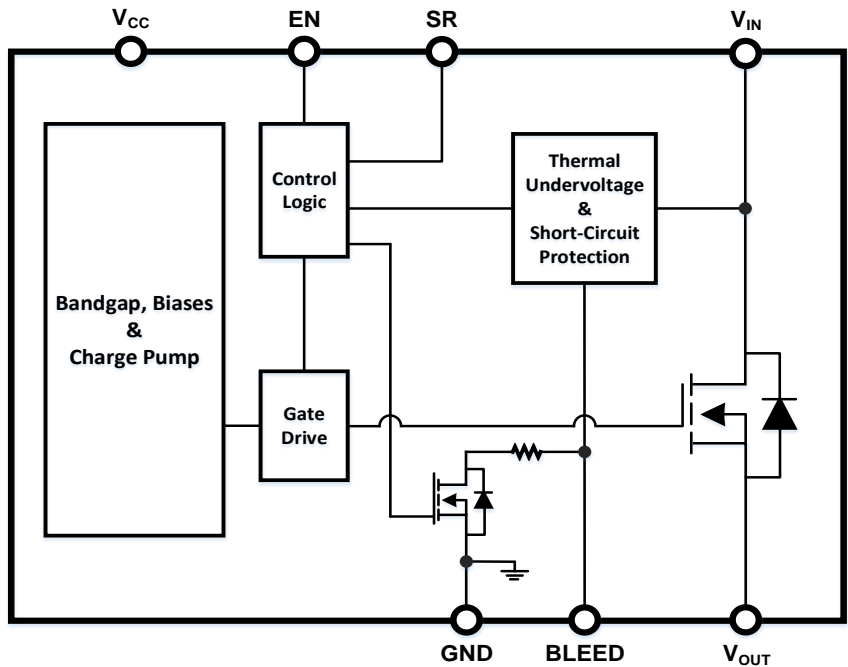

Absolute Maximum Rating

Parameter	Rating
V _{IN} , BLEED, V _{OUT} to GND	-0.3V to 24V
EN, V _{CC} , SR to GND	-0.3V to 6V
I _{MAX} *	10.5A
Storage Temperature (T _s)	-65°C to +150°C

Recommended Operating Ranges

Parameter	Rating
Supply Voltage (V _{CC})	3V to 5.5V
Input Voltage (V _{IN})	0.5V to 20V
Ambient Temperature (T _A)	-40°C to +85°C
Junction Temperature (T _J)	-40°C to +125°C
Package Thermal Resistance (θ _{JC})	5.3°C/W
Package Thermal Resistance (θ _{JA})	40°C/W

*I_{MAX} defined as the maximum steady state current the load switch can pass at room ambient temperature without entering thermal lockout.

Electrical Characteristics

(T_A = +25°C, V_{VCC} = 3.3V, V_{VIN} = 5V, C_{VIN} = 1μF, C_{VOUT} = 0.1μF, C_{VCC} = 1μF, C_{SR} = 1nF, unless otherwise specified.)

Symbol	Parameter	Conditions	Min	Typ	Max	Unit
V _{IN}	Input Voltage	—	0.5	—	20	V
V _{CC}	Supply Voltage	—	3.0	—	5.5	V
I _{DYN}	V _{CC} Dynamic Supply Current	V _{EN} = V _{CC} = 3V, V _{IN} = 20V	—	150	290	μA
		V _{EN} = V _{CC} = 5.5V, V _{IN} = 1.8V	—	200	390	μA
I _{STBY}	V _{CC} Shutdown Supply Current	V _{CC} = 3V, V _{EN} = 0V	—	0.1	1	μA
		V _{CC} = 5.5V, V _{EN} = 0V	—	0.1	2	μA
V _{ENH}	EN High Level Voltage	V _{CC} = 3V to 5.5V	2.0	—	—	V
V _{ENL}	EN Low Level Voltage	V _{CC} = 3V to 5.5V	—	—	0.8	V
R _{BLEED}	Bleed Resistance	V _{CC} = 3V, V _{EN} = 0V	90	120	180	Ω
		V _{CC} = 5.5V, V _{EN} = 0V	70	100	130	Ω
I _{BLEED}	Bleed Pin Leakage Current	V _{CC} = V _{EN} = 3V, V _{IN} = 1.8V	—	3	—	μA
		V _{CC} = V _{EN} = 3V, V _{IN} = 20V	—	32	—	μA
Switching Device						
R _{ON}	Switch On-State Resistance	V _{CC} = 3.3V, V _{IN} = 1.8V	—	10	12.5	mΩ
		V _{CC} = 3.3V, V _{IN} = 5V	—	10	12.5	mΩ
		V _{CC} = 3.3V, V _{IN} = 12V	—	10	12.5	mΩ
		V _{CC} = 5V, V _{IN} = 1.8V	—	7.5	10.5	mΩ
		V _{CC} = 5V, V _{IN} = 5V	—	7.5	10.5	mΩ
		V _{CC} = 5V, V _{IN} = 12V	—	7.5	10.5	mΩ
I _{LEAK}	Input Shutdown Supply Current	V _{EN} = 0V, V _{IN} = 20V	—	—	10	μA
R _{PDEN}	EN Pulldown Resistance	—	70	100	130	kΩ
Fault Protection						
T _{OTP}	Thermal Shutdown Threshold	V _{CC} = 3V to 5.5V	—	+145	—	°C
T _{OTPHYS}	Thermal Shutdown Hysteresis	V _{CC} = 3V to 5.5V	—	+20	—	°C
V _{UVLO}	V _{CC} Lockout Threshold	—	2.3	2.55	2.8	V
V _{UVLOHYS}	V _{CC} Lockout Hysteresis	—	—	200	—	mV
V _{SCP}	Short-Circuit Protection Threshold	V _{CC} = 3.3V, V _{IN} = 0.5V	140	240	350	mV
		V _{CC} = 3.3V, V _{IN} = 1.2V to 12V	120	240	500	mV
		V _{CC} = 3.3V, V _{IN} = 20V	100	250	500	mV

Switching Characteristics

($T_A = +25^\circ\text{C}$, $V_{\text{TERM}} = V_{\text{CC}} = 5\text{V}$, $C_{\text{SR}} = \text{floating}$, $R_{\text{VOUT}} = 10\Omega$, $C_{\text{VIN}} = 1\mu\text{F}$, $C_{\text{VOUT}} = 0.1\mu\text{F}$, $C_{\text{VCC}} = 1\mu\text{F}$, unless otherwise specified.)

Symbol	Parameter	Condition	Min	Typ	Max	Unit
$V_{\text{IN}} = 1.8\text{V}$						
t_{ON}	Output Turn-On Delay Time	$V_{\text{CC}} = 3.3\text{V}$	100	350	600	μs
		$V_{\text{CC}} = 5\text{V}$	60	220	400	
t_{OFF}	Output Turn-Off Delay Time	$V_{\text{CC}} = 3.3\text{V}$	—	1	2	μs
		$V_{\text{CC}} = 5\text{V}$	—	1	2	
SR	Output Slew Rate	$V_{\text{CC}} = 3.3\text{V}$	1	10	20	kV/s
		$V_{\text{CC}} = 5\text{V}$	1	10	20	
$V_{\text{IN}} = 12\text{V}$						
t_{ON}	Output Turn-On Delay Time	$V_{\text{CC}} = 3.3\text{V}$	100	300	600	μs
		$V_{\text{CC}} = 5\text{V}$	60	170	400	
t_{OFF}	Output Turn-Off Delay Time	$V_{\text{CC}} = 3.3\text{V}$	—	1	2	μs
		$V_{\text{CC}} = 5\text{V}$	—	1	2	
SR	Output Slew Rate	$V_{\text{CC}} = 3.3\text{V}$	5	20	40	kV/s
		$V_{\text{CC}} = 5\text{V}$	5	20	40	

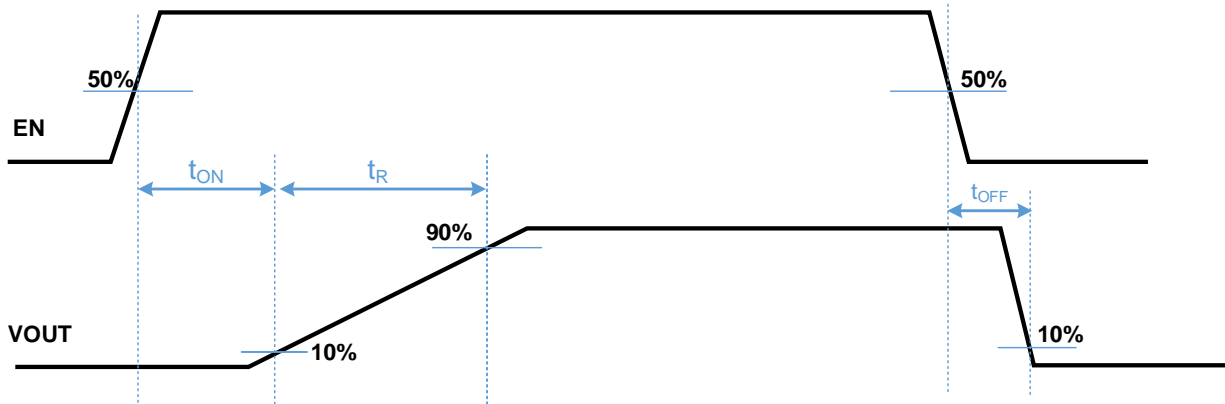
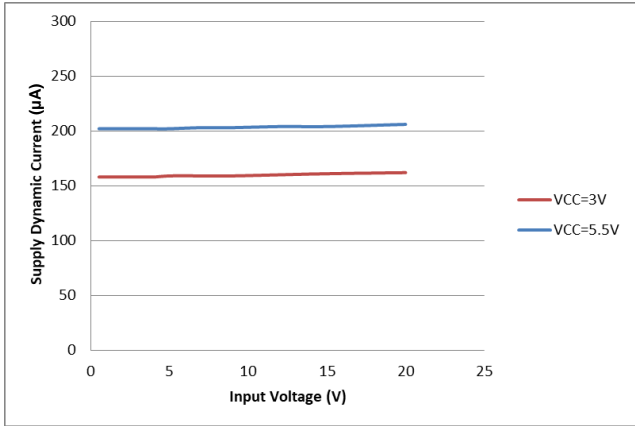

Figure 1. Timing Diagram

Performance Characteristics (@T_A = +25°C, unless otherwise specified.)

Supply Dynamic Current vs. Input Voltage



Supply Dynamic Current vs. Supply Voltage

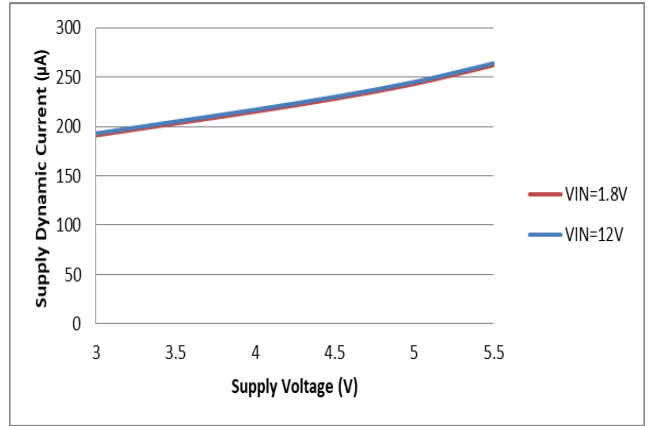

Bleed Resistance vs. Supply Voltage

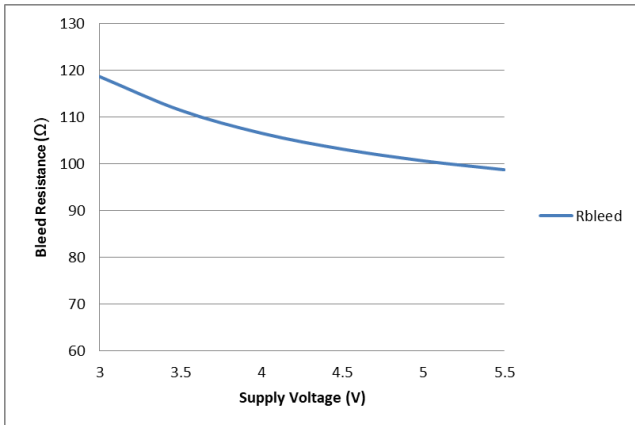

Bleed Leakage Current vs. Input Voltage

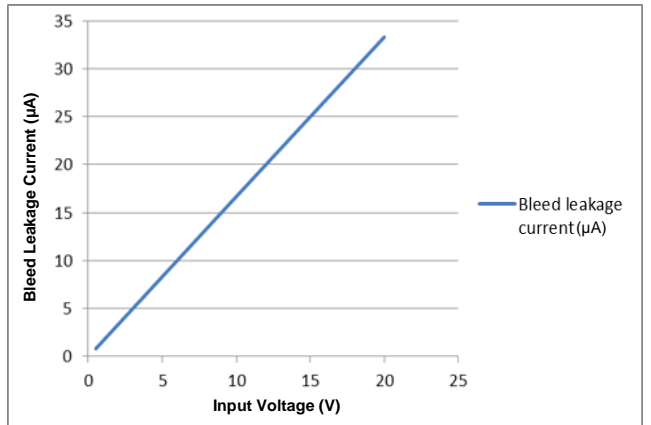

ON Resistance vs. Input Voltage

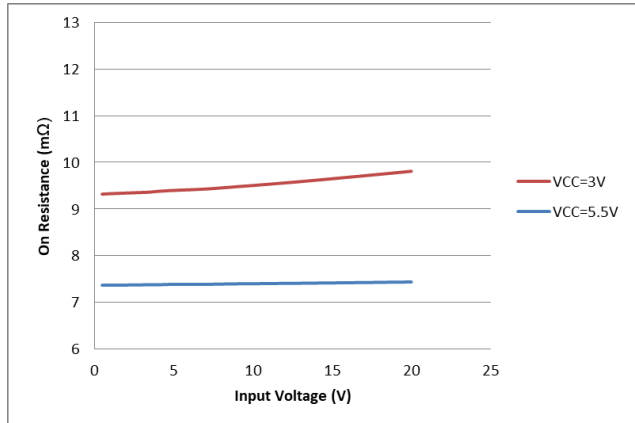

Performance Characteristics (@ $T_A = +25^\circ\text{C}$, unless otherwise specified.) (continued)

Turn ON Response

$V_{IN} = 1.8\text{V}$, $V_{CC} = 3.3\text{V}$, $V_{EN} = 0\text{V}$ to 3.3V , $C_{SR} = 1\text{nF}$, $R_L = 10\Omega$



Turn OFF Response

$V_{IN} = 1.8\text{V}$, $V_{CC} = 3.3\text{V}$, $V_{EN} = 0\text{V}$ to 3.3V , $C_{SR} = 1\text{nF}$, $R_L = 10\Omega$



Turn ON Response

$V_{IN} = 5\text{V}$, $V_{CC} = 3.3\text{V}$, $V_{EN} = 0\text{V}$ to 3.3V , $C_{SR} = 1\text{nF}$, $R_L = 10\Omega$

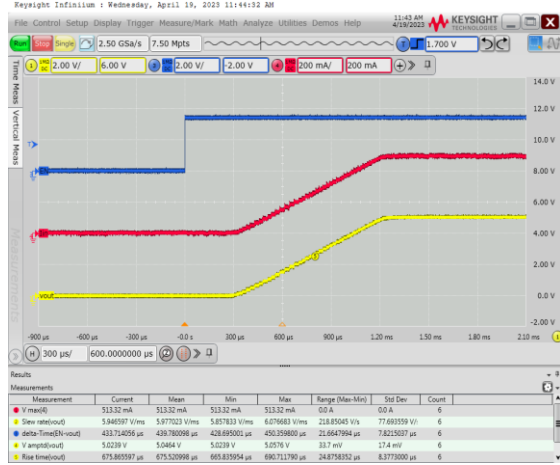

Turn OFF Response

$V_{IN} = 5\text{V}$, $V_{CC} = 3.3\text{V}$, $V_{EN} = 0\text{V}$ to 3.3V , $C_{SR} = 1\text{nF}$, $R_L = 10\Omega$



Turn ON Response

$V_{IN} = 12\text{V}$, $V_{CC} = 3.3\text{V}$, $V_{EN} = 0\text{V}$ to 3.3V , $C_{SR} = 1\text{nF}$, $R_L = 10\Omega$



Turn OFF Response

$V_{IN} = 12\text{V}$, $V_{CC} = 3.3\text{V}$, $V_{EN} = 0\text{V}$ to 3.3V , $C_{SR} = 1\text{nF}$, $R_L = 10\Omega$



Performance Characteristics (@ $T_A = +25^\circ\text{C}$, unless otherwise specified.) (continued)

Turn ON Response

$V_{IN} = 1.8\text{V}$, $V_{VCC} = 5\text{V}$, $V_{EN} = 0\text{V}$ to 3.3V , $C_{SR} = 1\text{nF}$, $R_L = 10\Omega$

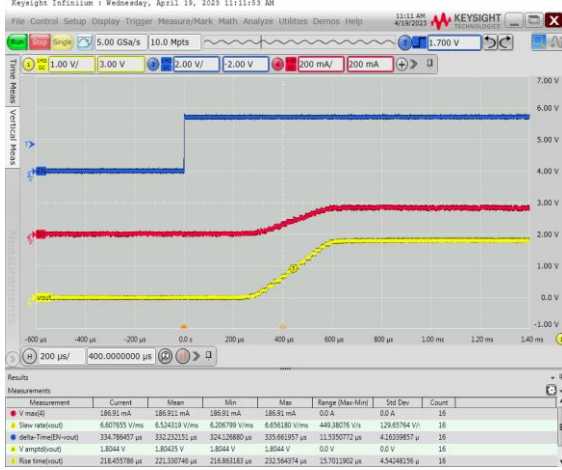

Turn OFF Response

$V_{IN} = 1.8\text{V}$, $V_{VCC} = 5\text{V}$, $V_{EN} = 0\text{V}$ to 3.3V , $C_{SR} = 1\text{nF}$, $R_L = 10\Omega$

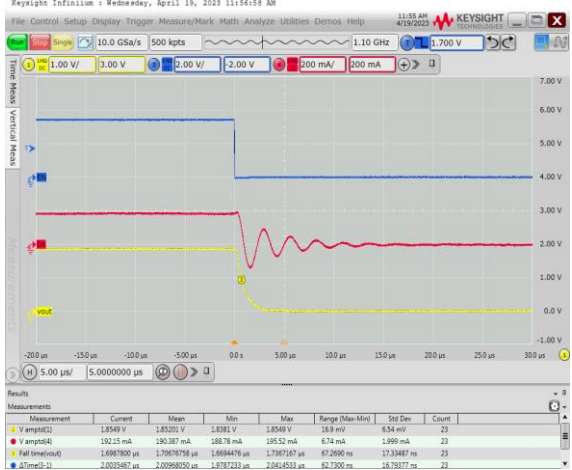

Turn ON Response

$V_{IN} = 5\text{V}$, $V_{VCC} = 5\text{V}$, $V_{EN} = 0\text{V}$ to 3.3V , $C_{SR} = 1\text{nF}$, $R_L = 10\Omega$

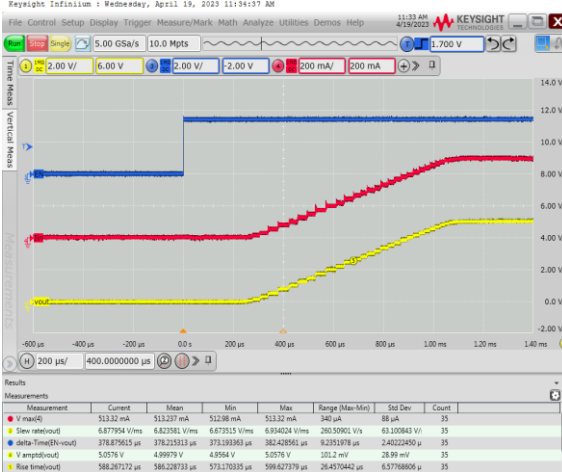

Turn OFF Response

$V_{IN} = 5\text{V}$, $V_{VCC} = 5\text{V}$, $V_{EN} = 0\text{V}$ to 3.3V , $C_{SR} = 1\text{nF}$, $R_L = 10\Omega$

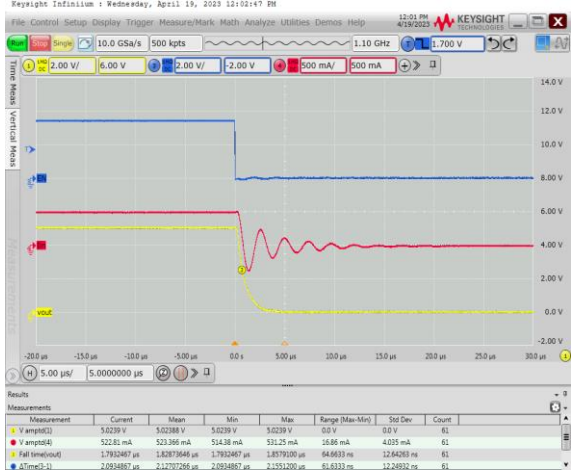

Turn ON Response

$V_{IN} = 12\text{V}$, $V_{VCC} = 5\text{V}$, $V_{EN} = 0\text{V}$ to 3.3V , $C_{SR} = 1\text{nF}$, $R_L = 10\Omega$

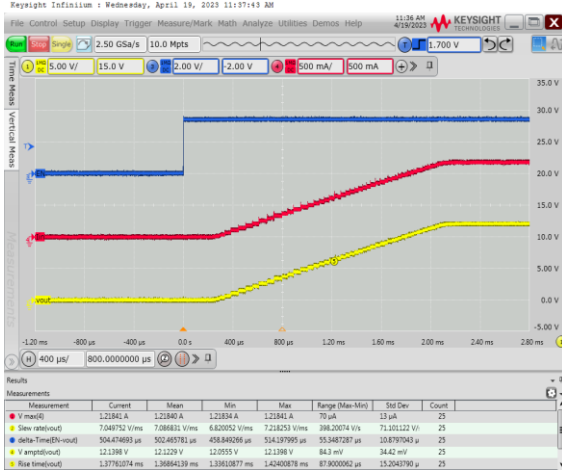

Turn OFF Response

$V_{IN} = 12\text{V}$, $V_{VCC} = 5\text{V}$, $V_{EN} = 0\text{V}$ to 3.3V , $C_{SR} = 1\text{nF}$, $R_L = 10\Omega$



Application Information

General Description

The DML3011ALFDS is a single channel load switch with a controlled adjustable turn-on in an 8-pin V-DFN2020-8 (Type N) package. The device contains an n-channel MOSFET that can operate over an input voltage range of 0.5V to 20V and can support a maximum continuous current of 10.5A. The wide input voltage range and high current capability enable the device to be used across multiple designs and end equipment. 10mΩ on-resistance minimizes the voltage drop across the load switch and power loss from the load switch.

During shutdown, the device has very low leakage current, thereby reducing unnecessary leakages for downstream modules during standby. The DML3011ALFDS also has 100Ω on-chip resistor embedded on BLEED pin for quick discharge of the output when switch is disabled.

Enable Control

The DML3011ALFDS allows for enabling the MOSFET in an active-high configuration. When the V_{CC} supply pin has an adequate voltage applied and the EN pin is at logic high level, the MOSFET will be enabled. Similarly, when the EN pin is at logic low level, the MOSFET will be disabled. An internal pulldown resistor to ground on the EN pin ensures that the MOSFET will be disabled when not being driven.

Power Sequencing

The DML3011ALFDS functions with fixed power sequence, the performance of output turn-on delay may vary from what is specified. To achieve the specified performance, recommended power sequences are:

- 1.) V_{CC} → V_{IN} → V_{EN}
- 2.) V_{IN} → V_{CC} → V_{EN}

Load Bleed (Quick Discharge)

The DML3011ALFDS has an internal bleed discharge device, which is used to bleed the charge off from the load to ground after the MOSFET is disabled. The bleed discharge device is enabled whenever the MOSFET is disabled. The MOSFET and the bleed device are never concurrently active.

The BLEED pin must be connected to V_{OUT} either directly or through an external resistor, R_{EXT}. R_{EXT} should not exceed 1kΩ and can be used to increase the total bleed resistance.

To ensure that the power dissipated across R_{BLEED} is kept at safe level, dissipated power of R_{BLEED} needs to be detailedly calculated. The maximum continuous power that can be dissipated across R_{BLEED} is 0.4W. R_{EXT} can be used to decrease the amount of power dissipated across R_{BLEED}.

Adjustable Rise Time (Slew Rate Control)

The DML3011ALFDS has controlled rise time for inrush current control. A capacitor to ground on the SR pin adjusts the rise time. Without a capacitor on SR, the rise time is at its minimum for fastest timing. An approximate equation for the relationship between C_{SR}, V_{VIN}, and rise time when V_{CC} is set to 5V is shown in Equation 1. As shown in Figure 1, rise time is defined as from 10% to 90% measurement on V_{OUT}.

$$t_R = K1 \times ((C_{SR} \times K2) \times V_{VIN}) / I_{SR}$$

Where: K1 = 0.06 and K2 = 0.3

C_{SR} is the ramp-up control setting capacitor in nF

I_{SR} = 0.5μA is SR pin output current

t_R is the total ramp time in ms

Table 1 contains rise time values measured on a typical device. Rise times shown below are only valid for the power-up sequence 1.

Table 1. Rise Time vs. SR Capacitor

C _{SR}	Rise Time (ms)				
	V _{CC} = 5V, C _L = 0.1μF, R _L = 10Ω, +25°C; Measure V _{OUT} rising time from 10% to 90% V _{VIN}				
	V _{VIN} = 20V	V _{VIN} = 12V	V _{VIN} = 5V	V _{VIN} = 3.3V	V _{VIN} = 1.8V
0 (floating)	0.5	0.38	0.24	0.2	0.14
0.22nF	0.5	0.38	0.24	0.2	0.14
0.47nF	1.05	0.63	0.26	0.2	0.14
1nF	2.33	1.37	0.6	0.4	0.22
2.2nF	5.23	3.02	1.34	0.92	0.51
4.7nF	11.66	6.54	2.86	1.85	1.18
10nF	23.16	13.84	5.79	3.96	2.25

Note: An SR capacitor less than 47nF for system success startup recommended.

Application Information (continued)

Short-Circuit Protection

The DML3011ALFDS is equipped with short-circuit protection that is used to help protect the part and the system from a sudden high-current event, such as the output, V_{OUT} , being shorted to ground. This circuitry is only active when the gate of MOSFET is fully charged.

Once active, the circuitry monitors the difference in the voltage on the V_{IN} pin and the voltage on the BLEED pin. In order for the V_{OUT} voltage to be monitored through the BLEED pin, it is required that BLEED pin be connected to V_{OUT} either directly or through a resistor, R_{EXT} , which should not exceed 1k Ω . With the BLEED pin connected to V_{OUT} , the short-circuit protection is able to monitor the voltage drop across the MOSFET.

If the voltage drop across the MOSFET is greater than or equal to the short-circuit protection threshold voltage, the MOSFET is turned off immediately and the load bleed is activated. The part remains latched in this off state until EN is toggled or V_{CC} supply voltage is cycled, at which point the MOSFET will be turn-on delay and slew rate. The current through the MOSFET that will cause a short-circuit event can be calculated by dividing the short-circuit protection threshold by expected on-resistance of the MOSFET.

Thermal Shutdown

The DML3011ALFDS is equipped with thermal shutdown protection for internal or externally generated excessive temperatures. This circuitry is disabled when EN is not active to reduce standby current. When an overtemperature condition is detected, the MOSFET is turned off immediately and the load bleed is active.

The part comes out of thermal shutdown when the junction temperature decreases to a safe operating temperature as dictated by the thermal hysteresis. Upon exiting a thermal shutdown state, and if EN remains active, the MOSFET will be turned on in a controlled fashion with the normal output turn-on delay and slew rate.

Undervoltage Lockout

The DML3011ALFDS is equipped with undervoltage lockout protection. DML3011ALFDS turns the MOSFET off and activates the load bleed when the input voltage V_{CC} is less than or equal to the undervoltage lockout threshold. This circuitry is disabled when EN is not active to reduce standby current.

If the V_{CC} voltage rises above the undervoltage lockout threshold and EN remains active, the MOSFET will be turned on in a controlled fashion with the normal output turn-on delay and slew rate.

PCB Layout Consideration

1. Place the input/output capacitors C_{VIN} and C_{VOUT} as close as possible to the V_{IN} and V_{OUT} pins.
2. The power traces which are V_{IN} trace, V_{OUT} trace and GND trace should be short, wide and directly for minimizing parasitic inductance.
3. Place feedback resistance R_{BLEED} as close as possible to BLEED pin.
4. Place C_{VCC} capacitor near the device pin.
5. Connect the signal ground to the GND pin, and keep a single connection from GND pin to the power ground behind the input or output capacitors.
6. For better power dissipation, via holes are recommended to connect the exposed pad's landing area to a large copper polygon on the other side of the printed circuit board. The copper polygons and exposed pad shall connect to V_{IN} pin on the printed circuit board.

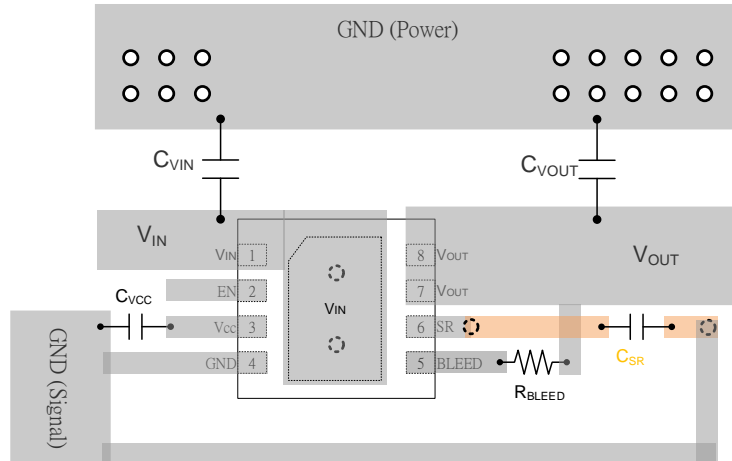

Package Outline Dimensions

Please see <http://www.diodes.com/package-outlines.html> for the latest version.

V-DFN2020-8 (Type N)

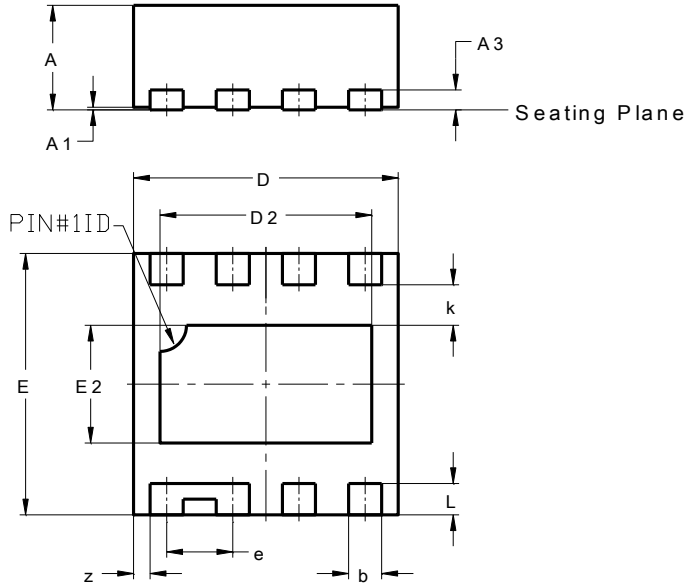

V-DFN2020-8 (Type N)			
Dim	Min	Max	Typ
A	0.75	0.85	0.80
A1	0.00	0.05	0.02
A3	--	--	0.152
b	0.20	0.30	0.25
D	1.95	2.05	2.00
D2	1.50	1.70	1.60
E	1.95	2.05	2.00
E2	0.80	1.00	0.90
e	--	--	0.50
k	--	--	0.31
L	0.19	0.29	0.24
z	--	--	0.125
All Dimensions in mm			

Suggested Pad Layout

Please see <http://www.diodes.com/package-outlines.html> for the latest version.

V-DFN2020-8 (Type N)

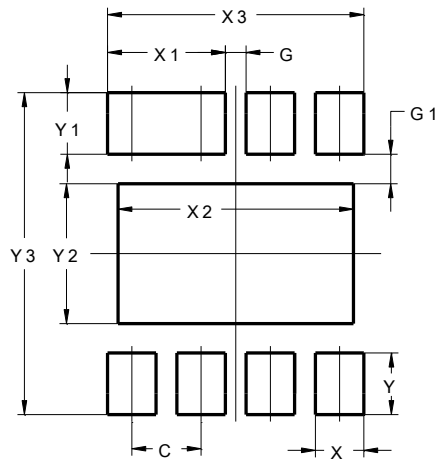

Dimensions	Value (in mm)
C	0.500
G	0.150
G1	0.210
X	0.350
X1	0.850
X2	1.700
X3	1.850
Y	0.440
Y1	0.440
Y2	1.000
Y3	2.300

IMPORTANT NOTICE

1. DIODES INCORPORATED (Diodes) AND ITS SUBSIDIARIES MAKE NO WARRANTY OF ANY KIND, EXPRESS OR IMPLIED, WITH REGARDS TO ANY INFORMATION CONTAINED IN THIS DOCUMENT, INCLUDING, BUT NOT LIMITED TO, THE IMPLIED WARRANTIES OF MERCHANTABILITY, FITNESS FOR A PARTICULAR PURPOSE OR NON-INFRINGEMENT OF THIRD PARTY INTELLECTUAL PROPERTY RIGHTS (AND THEIR EQUIVALENTS UNDER THE LAWS OF ANY JURISDICTION).
2. The Information contained herein is for informational purpose only and is provided only to illustrate the operation of Diodes' products described herein and application examples. Diodes does not assume any liability arising out of the application or use of this document or any product described herein. This document is intended for skilled and technically trained engineering customers and users who design with Diodes' products. Diodes' products may be used to facilitate safety-related applications; however, in all instances customers and users are responsible for (a) selecting the appropriate Diodes products for their applications, (b) evaluating the suitability of Diodes' products for their intended applications, (c) ensuring their applications, which incorporate Diodes' products, comply the applicable legal and regulatory requirements as well as safety and functional-safety related standards, and (d) ensuring they design with appropriate safeguards (including testing, validation, quality control techniques, redundancy, malfunction prevention, and appropriate treatment for aging degradation) to minimize the risks associated with their applications.
3. Diodes assumes no liability for any application-related information, support, assistance or feedback that may be provided by Diodes from time to time. Any customer or user of this document or products described herein will assume all risks and liabilities associated with such use, and will hold Diodes and all companies whose products are represented herein or on Diodes' websites, harmless against all damages and liabilities.
4. Products described herein may be covered by one or more United States, international or foreign patents and pending patent applications. Product names and markings noted herein may also be covered by one or more United States, international or foreign trademarks and trademark applications. Diodes does not convey any license under any of its intellectual property rights or the rights of any third parties (including third parties whose products and services may be described in this document or on Diodes' website) under this document.
5. Diodes' products are provided subject to Diodes' Standard Terms and Conditions of Sale (<https://www.diodes.com/about/company/terms-and-conditions/terms-and-conditions-of-sales/>) or other applicable terms. This document does not alter or expand the applicable warranties provided by Diodes. Diodes does not warrant or accept any liability whatsoever in respect of any products purchased through unauthorized sales channel.
6. Diodes' products and technology may not be used for or incorporated into any products or systems whose manufacture, use or sale is prohibited under any applicable laws and regulations. Should customers or users use Diodes' products in contravention of any applicable laws or regulations, or for any unintended or unauthorized application, customers and users will (a) be solely responsible for any damages, losses or penalties arising in connection therewith or as a result thereof, and (b) indemnify and hold Diodes and its representatives and agents harmless against any and all claims, damages, expenses, and attorney fees arising out of, directly or indirectly, any claim relating to any noncompliance with the applicable laws and regulations, as well as any unintended or unauthorized application.
7. While efforts have been made to ensure the information contained in this document is accurate, complete and current, it may contain technical inaccuracies, omissions and typographical errors. Diodes does not warrant that information contained in this document is error-free and Diodes is under no obligation to update or otherwise correct this information. Notwithstanding the foregoing, Diodes reserves the right to make modifications, enhancements, improvements, corrections or other changes without further notice to this document and any product described herein. This document is written in English but may be translated into multiple languages for reference. Only the English version of this document is the final and determinative format released by Diodes.
8. Any unauthorized copying, modification, distribution, transmission, display or other use of this document (or any portion hereof) is prohibited. Diodes assumes no responsibility for any losses incurred by the customers or users or any third parties arising from any such unauthorized use.
9. This Notice may be periodically updated with the most recent version available at <https://www.diodes.com/about/company/terms-and-conditions/important-notice>

The Diodes logo is a registered trademark of Diodes Incorporated in the United States and other countries.
All other trademarks are the property of their respective owners.
© 2023 Diodes Incorporated. All Rights Reserved.

www.diodes.com