

## Product Summary

Device	BV <sub>DSS</sub>	R <sub>DS(ON)</sub> Max	I <sub>D</sub> Max T <sub>A</sub> = +25°C (Notes 6 & 8)
Q1	40V	25mΩ @ V <sub>GS</sub> = 10V	7.5A
		40mΩ @ V <sub>GS</sub> = 4.5V	6.2A
Q2	-40V	25mΩ @ V <sub>GS</sub> = -10V	-7.3A
		45mΩ @ V <sub>GS</sub> = -4.5V	-5.7A

## Features and Benefits

- Reduced Footprint with Two Discrete Devices in Single SO-8
- Low On-Resistance
- Fast Switching Speed
- Low Input/Output Leakage
- **Totally Lead-Free & Fully RoHS Compliant (Notes 1 & 2)**
- **Halogen and Antimony Free. "Green" Device (Note 3)**
- **The DMC4040SSDQ is suitable for automotive applications requiring specific change control; this part is AEC-Q101 qualified, PPAP capable, and manufactured in IATF16949 certified facilities.**  
<https://www.diodes.com/quality/product-definitions/>

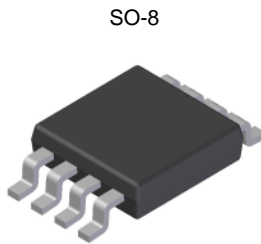
## Description and Applications

This MOSFET has been designed to ensure that R<sub>DS(ON)</sub> of n-channel and p-channel FETs are matched to minimize losses in both arms of the bridge. The DMC4040SSDQ is optimized for use in 3 phases brushless DC motor circuits (BLDC) and CCFL backlighting.

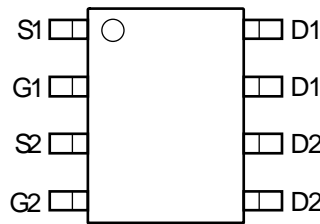
- 3 phases BLDC motors
- CCFL backlighting

## Mechanical Data

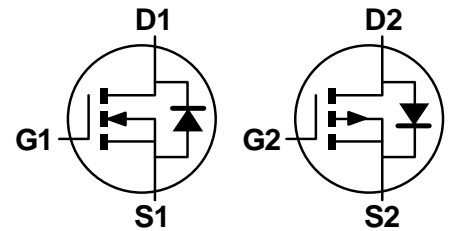
- Package: SO-8
- Package Material: Molded Plastic, "Green" Molding Compound. UL Flammability Classification Rating 94V-0
- Moisture Sensitivity: Level 1 per J-STD-020
- Terminals Connections: See Diagram Below
- Terminals: Finish – Matte Tin Annealed over Copper Lead Frame. Solderable per MIL-STD-202, Method 208 <sup>(e3)</sup>
- Weight: 0.074 grams (Approximate)



Top View



Top View



Q1 N-Channel

Q2 P-Channel

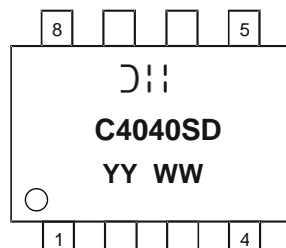
Equivalent Circuit

## Ordering Information (Note 4)

Part Number	Package	Packing	
		Qty.	Carrier
DMC4040SSDQ-13	SO-8	2,500	Tape & Reel

- Notes:
1. No purposely added lead. Fully EU Directive 2002/95/EC (RoHS), 2011/65/EU (RoHS 2) & 2015/863/EU (RoHS 3) compliant.
  2. See <https://www.diodes.com/quality/lead-free/> for more information about Diodes Incorporated's definitions of Halogen- and Antimony-free, "Green" and Lead-free.
  3. Halogen- and Antimony-free "Green" products are defined as those which contain <900ppm bromine, <900ppm chlorine (<1500ppm total Br + Cl) and <1000ppm antimony compounds.
  4. For packaging details, go to our website at <https://www.diodes.com/design/support/packaging/diodes-packaging/>.

## Marking Information



☽:: = Manufacturer's Marking  
 C4040SD = Product Type Marking Code  
 YYWW = Date Code Marking  
 YY = Year (ex: 23 = 2023)  
 WW = Week (01 to 53)

**Maximum Ratings** (@T<sub>A</sub> = +25°C, unless otherwise specified.)

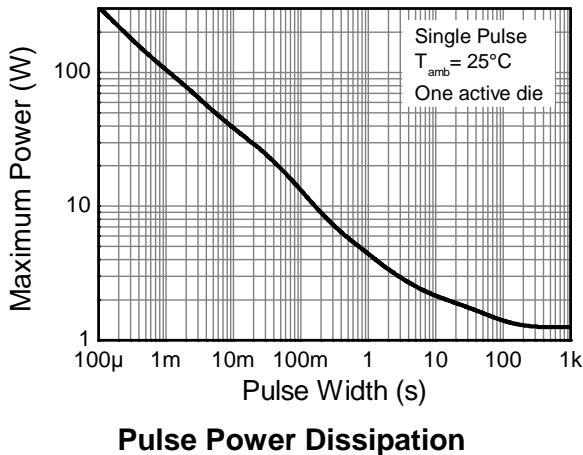
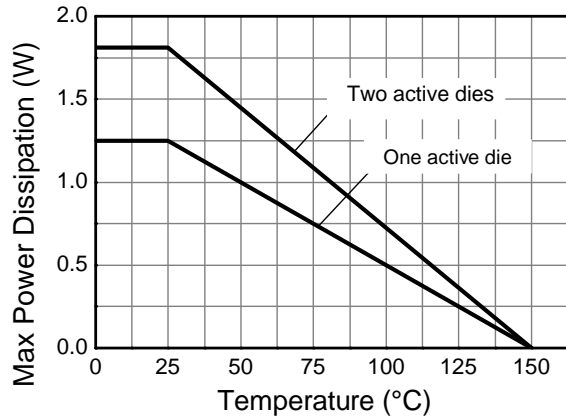
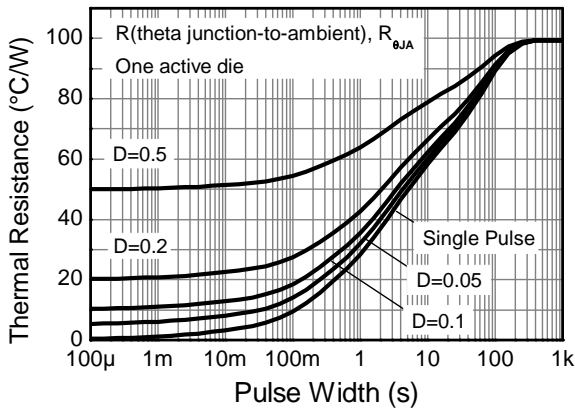
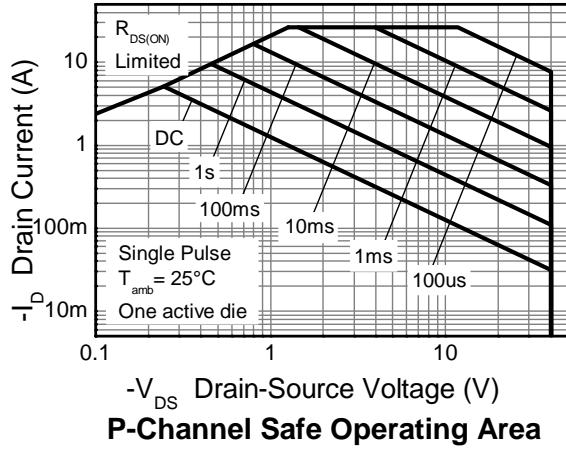
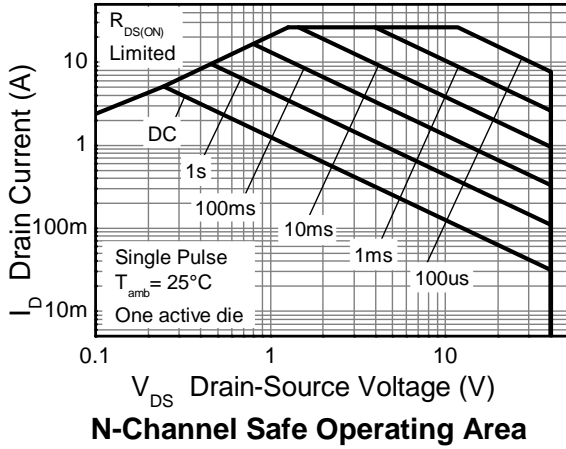
Characteristic			Symbol	N-Channel - Q1	P-Channel - Q2	Unit
Drain-Source Voltage			V <sub>DSS</sub>	40	-40	V
Gate-Source Voltage			V <sub>GSS</sub>	±20	±20	V
Continuous Drain Current	V <sub>GS</sub> = 10V	(Notes 6 & 8)	I <sub>D</sub>	7.5	-7.5	A
		T <sub>A</sub> = +70°C (Notes 6 & 8)		5.8	-5.8	
		(Notes 5 & 8)		5.7	-5.7	
		(Notes 5 & 9)		6.8	-6.8	
Pulsed Drain Current	V <sub>GS</sub> = 10V	(Notes 7 & 8)	I <sub>DM</sub>	29.0	-29.0	A
Continuous Source Current (Body Diode)			I <sub>S</sub>	3.0	-3.0	A
Pulsed Source Current (Body Diode)			I <sub>SM</sub>	29.0	-29.0	A

**Thermal Characteristics** (@T<sub>A</sub> = +25°C, unless otherwise specified.)

Characteristic		Symbol	N-Channel - Q1	P-Channel - Q2	Unit
Power Dissipation Linear Derating Factor	(Notes 5 & 8)	P <sub>D</sub>	1.25		W mW/°C
	(Notes 5 & 9)		10		
	(Notes 6 & 8)		1.8		
	(Notes 6 & 8)		14.3		
Thermal Resistance, Junction to Ambient	(Notes 5 & 8)	R <sub>θJA</sub>	2.14		°C/W
	(Notes 5 & 9)		17.2		
	(Notes 6 & 8)		100		
Thermal Resistance, Junction to Lead	(Notes 8 & 10)	R <sub>θJL</sub>	70		
Operating and Storage Temperature Range		T <sub>J</sub> , T <sub>STG</sub>	51	-55 to +150	°C

- Notes:
5. For a device surface-mounted on 25mm x 25mm x 1.6mm FR4 PCB with high coverage of single sided 1oz copper, in still air conditions; the device is measured when operating in a steady-state condition.
  6. Same as Note 5, except the device is measured at t ≤ 10sec.
  7. Same as Note 5, except the device is pulsed with D = 0.02 and pulse width = 300µs. The pulse current is limited by the maximum junction temperature.
  8. For a dual device with one active die.
  9. For a device with two active dies running at equal power.
  10. Thermal resistance from junction to solder-point (at the end of the drain lead).

**Thermal Characteristics**



**Electrical Characteristics – Q1 N-Channel** (@T<sub>A</sub> = +25°C, unless otherwise specified.)

Characteristic	Symbol	Min	Typ	Max	Unit	Test Condition
<b>OFF CHARACTERISTICS</b>						
Drain-Source Breakdown Voltage	BV <sub>DSS</sub>	40	—	—	V	I <sub>D</sub> = 250μA, V <sub>GS</sub> = 0V
Zero Gate Voltage Drain Current	I <sub>DSS</sub>	—	—	1.0	μA	V <sub>DS</sub> = 40V, V <sub>GS</sub> = 0V
Gate-Source Leakage	I <sub>GSS</sub>	—	—	±100	nA	V <sub>GS</sub> = ±20V, V <sub>DS</sub> = 0V
<b>ON CHARACTERISTICS</b>						
Gate Threshold Voltage	V <sub>GS(TH)</sub>	0.8	1.3	1.8	V	I <sub>D</sub> = 250μA, V <sub>DS</sub> = V <sub>GS</sub>
Static Drain-Source On-Resistance (Note 11)	R <sub>DS(ON)</sub>	—	0.013	0.025	Ω	V <sub>GS</sub> = 10V, I <sub>D</sub> = 3A
			0.028	0.040		V <sub>GS</sub> = 4.5V, I <sub>D</sub> = 3A
Forward Transconductance (Notes 11 & 12)	g <sub>fs</sub>	—	12.6	—	S	V <sub>DS</sub> = 5V, I <sub>D</sub> = 3A
Diode Forward Voltage (Note 7)	V <sub>SD</sub>	—	0.7	1.0	V	I <sub>S</sub> = 1A, V <sub>GS</sub> = 0V
<b>DYNAMIC CHARACTERISTICS (Note 12)</b>						
Input Capacitance	C <sub>iss</sub>	—	1790	—	pF	V <sub>DS</sub> = 20V, V <sub>GS</sub> = 0V f = 1MHz
Output Capacitance	C <sub>oss</sub>	—	160	—	pF	
Reverse Transfer Capacitance	C <sub>rss</sub>	—	120	—	pF	
Gate Resistance	R <sub>g</sub>	—	1.03	—	Ω	V <sub>DS</sub> = 0V, V <sub>GS</sub> = 0V, f = 1MHz
Total Gate Charge (Note 13)	Q <sub>g</sub>	—	16.0	—	nC	V <sub>GS</sub> = 4.5V V <sub>GS</sub> = 10V V <sub>DS</sub> = 20V I <sub>D</sub> = 3A
Total Gate Charge (Note 13)	Q <sub>g</sub>	—	37.6	—	nC	
Gate-Source Charge (Note 13)	Q <sub>gs</sub>	—	7.8	—	nC	
Gate-Drain Charge (Note 13)	Q <sub>gd</sub>	—	6.6	—	nC	
Turn-On Delay Time (Note 13)	t <sub>D(ON)</sub>	—	8.1	—	ns	V <sub>DD</sub> = 20V, V <sub>GS</sub> = 10V I <sub>D</sub> = 3A
Turn-On Rise Time (Note 13)	t <sub>R</sub>	—	15.1	—	ns	
Turn-Off Delay Time (Note 13)	t <sub>D(OFF)</sub>	—	24.3	—	ns	
Turn-Off Fall Time (Note 13)	t <sub>F</sub>	—	5.3	—	ns	

Notes: 11. Measured under pulsed conditions. Pulse width ≤ 300μs; duty cycle ≤ 2%.  
 12. For design aid only, not subject to production testing.  
 13. Switching characteristics are independent of operating junction temperatures.

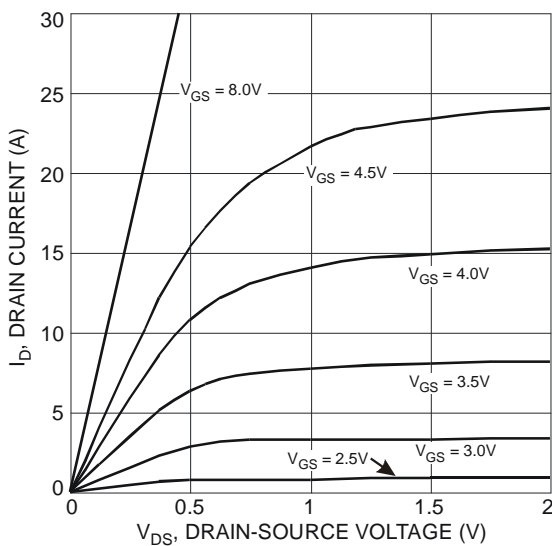
**Typical Characteristics – Q1 N-Channel**


Fig. 1 Typical Output Characteristic

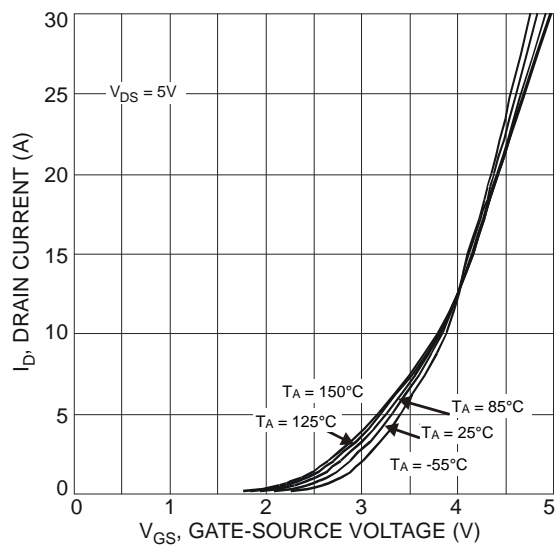


Fig. 2 Typical Transfer Characteristic

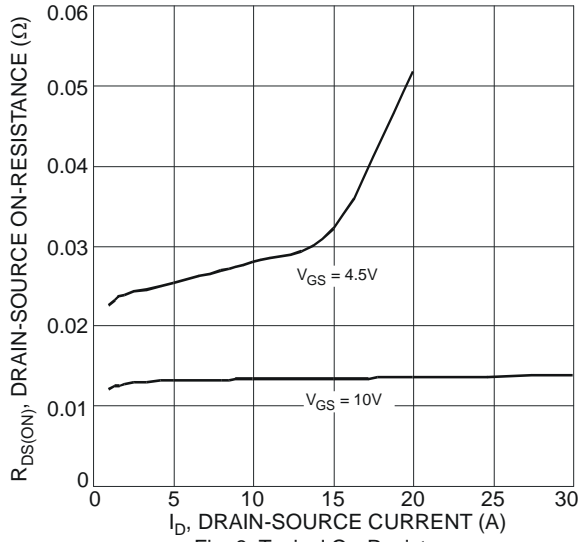


Fig. 3 Typical On-Resistance vs. Drain Current and Gate Voltage

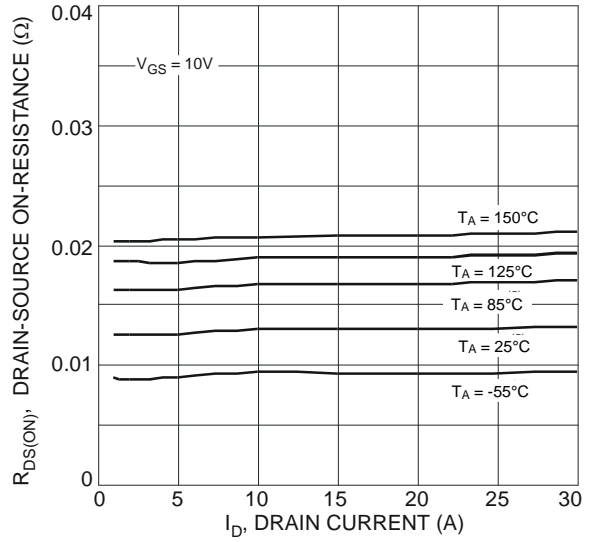


Fig. 4 Typical On-Resistance vs. Drain Current and Temperature

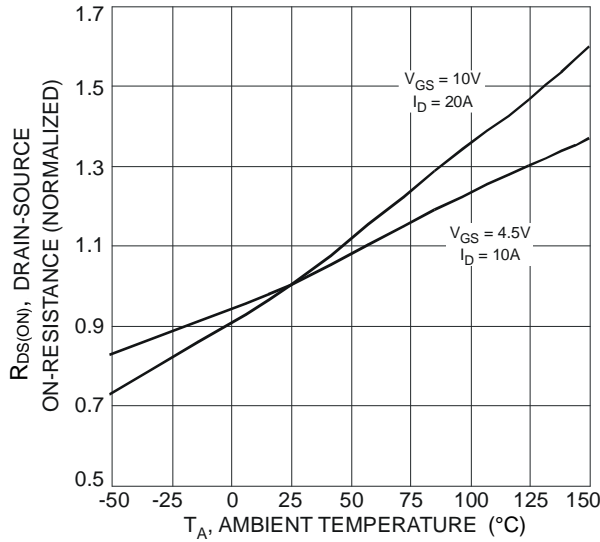


Fig. 5 On-Resistance Variation with Temperature

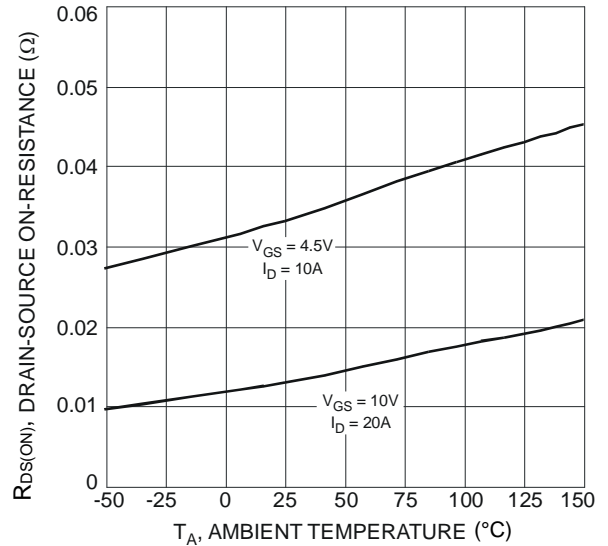


Fig. 6 On-Resistance Variation with Temperature

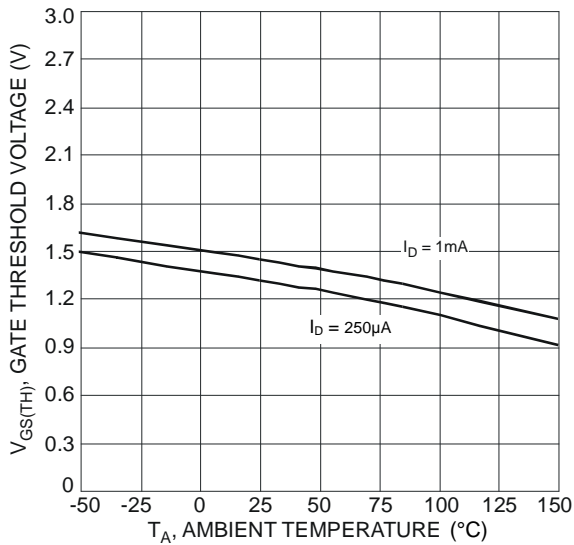


Fig. 7 Gate Threshold Variation vs. Ambient Temperature

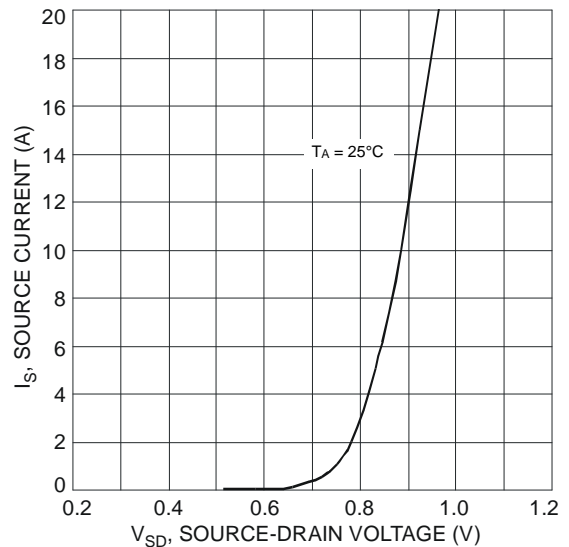


Fig. 8 Diode Forward Voltage vs. Current

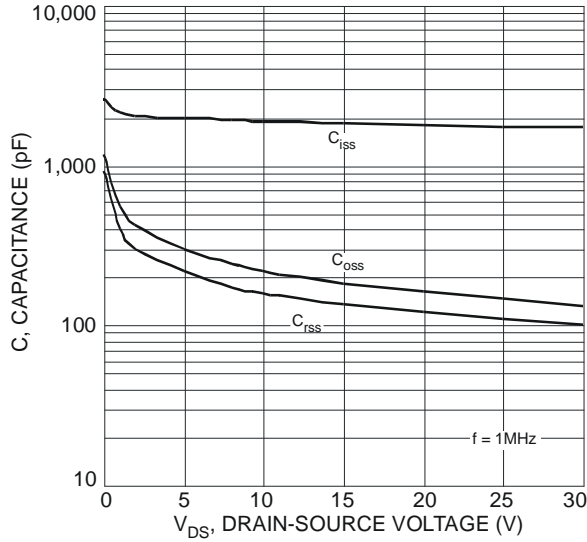


Fig. 9 Typical Total Capacitance

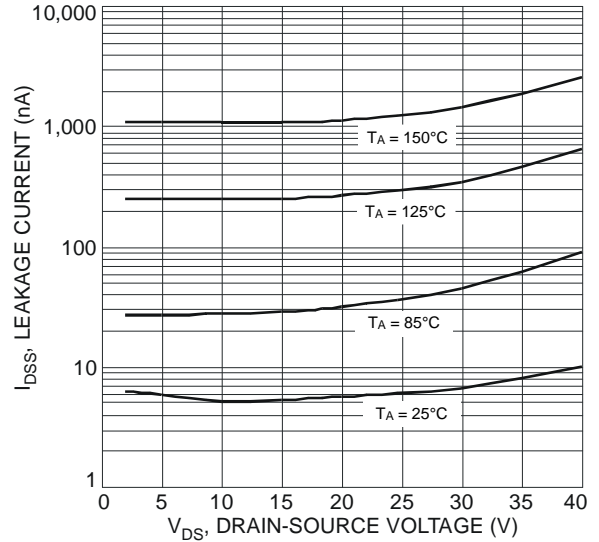


Fig. 10 Typical Leakage Current vs. Drain-Source Voltage

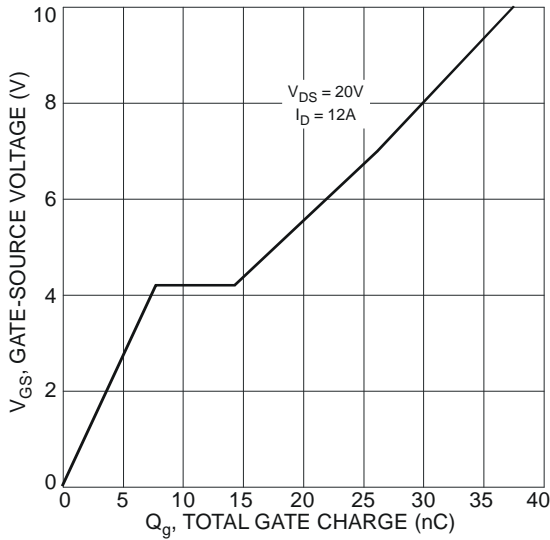


Fig. 11 Gate-Charge Characteristics

**Electrical Characteristics – Q2 P-Channel** (@T<sub>A</sub> = +25°C, unless otherwise specified.)

Characteristic	Symbol	Min	Typ	Max	Unit	Test Condition
<b>OFF CHARACTERISTICS</b>						
Drain-Source Breakdown Voltage	BV <sub>DSS</sub>	-40	—	—	V	I <sub>D</sub> = -250μA, V <sub>GS</sub> = 0V
Zero Gate Voltage Drain Current	I <sub>DSS</sub>	—	—	-1.0	μA	V <sub>DS</sub> = -40V, V <sub>GS</sub> = 0V
Gate-Source Leakage	I <sub>GSS</sub>	—	—	±100	nA	V <sub>GS</sub> = ±20V, V <sub>DS</sub> = 0V
<b>ON CHARACTERISTICS</b>						
Gate Threshold Voltage	V <sub>GS(TH)</sub>	-0.8	-1.3	-1.8	V	I <sub>D</sub> = -250μA, V <sub>DS</sub> = V <sub>GS</sub>
Static Drain-Source On-Resistance (Note 14)	R <sub>DS(ON)</sub>	—	0.018	0.025	Ω	V <sub>GS</sub> = -10V, I <sub>D</sub> = -3A
			0.030	0.045		V <sub>GS</sub> = -4.5V, I <sub>D</sub> = -3A
Forward Transconductance (Notes 14 & 15)	g <sub>fs</sub>	—	16.6	—	S	V <sub>DS</sub> = -5V, I <sub>D</sub> = -3A
Diode Forward Voltage (Note 14)	V <sub>SD</sub>	—	-0.7	-1.0	V	I <sub>S</sub> = -1A, V <sub>GS</sub> = 0V
<b>DYNAMIC CHARACTERISTICS (Note 15)</b>						
Input Capacitance	C <sub>iss</sub>	—	1643	—	pF	V <sub>DS</sub> = -20V, V <sub>GS</sub> = 0V f = 1MHz
Output Capacitance	C <sub>oss</sub>	—	179	—	pF	
Reverse Transfer Capacitance	C <sub>rss</sub>	—	128	—	pF	
Gate Resistance	R <sub>g</sub>	—	6.43	—	Ω	V <sub>DS</sub> = 0V, V <sub>GS</sub> = 0V, f = 1MHz
Total Gate Charge (Note 16)	Q <sub>g</sub>	—	14.0	—	nC	V <sub>GS</sub> = -4.5V V <sub>DS</sub> = -20V I <sub>D</sub> = -3A
Total Gate Charge (Note 16)	Q <sub>g</sub>	—	33.7	—	nC	
Gate-Source Charge (Note 16)	Q <sub>gs</sub>	—	5.5	—	nC	
Gate-Drain Charge (Note 16)	Q <sub>gd</sub>	—	7.3	—	nC	
Turn-On Delay Time (Note 16)	t <sub>D(ON)</sub>	—	6.9	—	ns	V <sub>DD</sub> = -20V, V <sub>GS</sub> = -10V I <sub>D</sub> = -3A
Turn-On Rise Time (Note 16)	t <sub>R</sub>	—	14.7	—	ns	
Turn-Off Delay Time (Note 16)	t <sub>D(OFF)</sub>	—	53.7	—	ns	
Turn-Off Fall Time (Note 16)	t <sub>F</sub>	—	30.9	—	ns	

Notes: 14. Measured under pulsed conditions. Pulse width ≤ 300μs; duty cycle ≤ 2%.  
 15. For design aid only, not subject to production testing.  
 16. Switching characteristics are independent of operating junction temperatures.

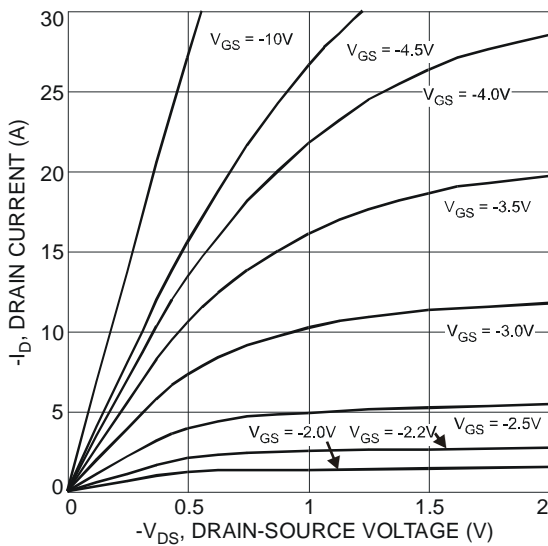
**Typical Characteristics – Q2 P-Channel**


Fig. 12 Typical Output Characteristic

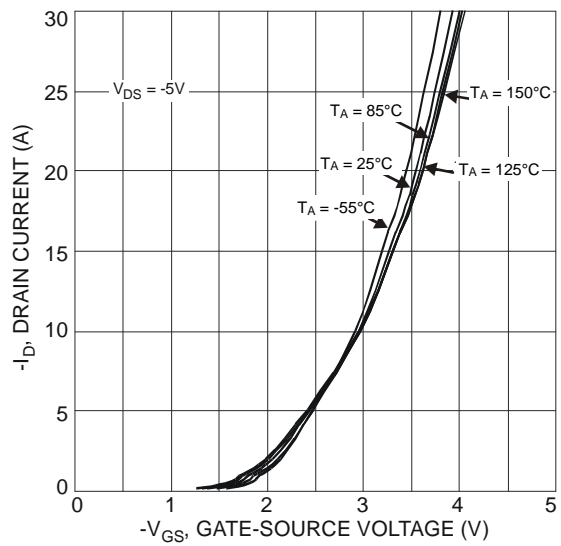


Fig. 13 Typical Transfer Characteristic

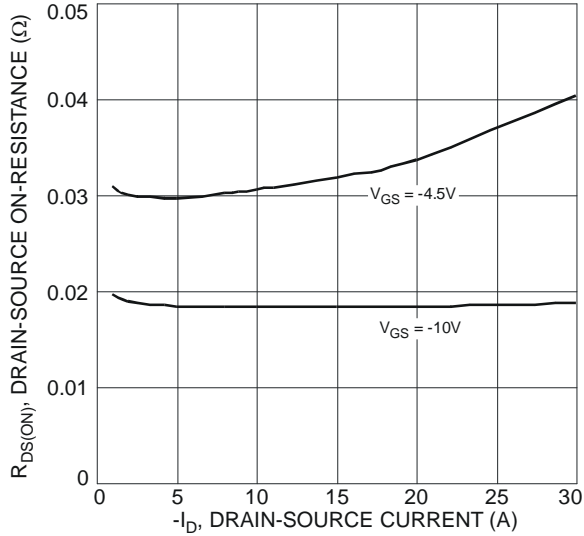


Fig. 14 Typical On-Resistance vs. Drain Current and Gate Voltage

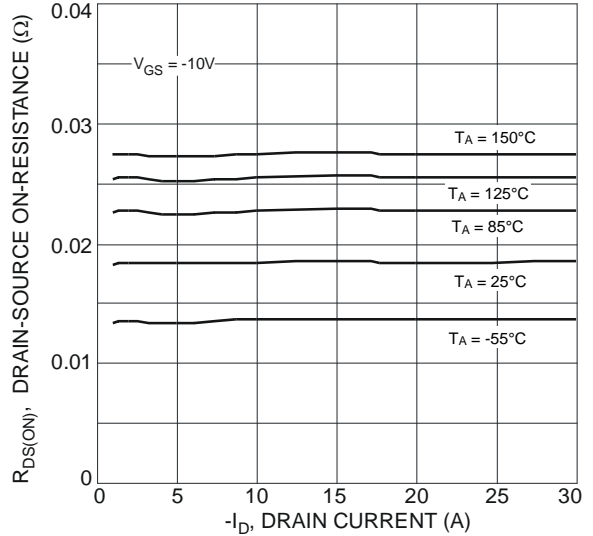


Fig. 15 Typical On-Resistance vs. Drain Current and Temperature

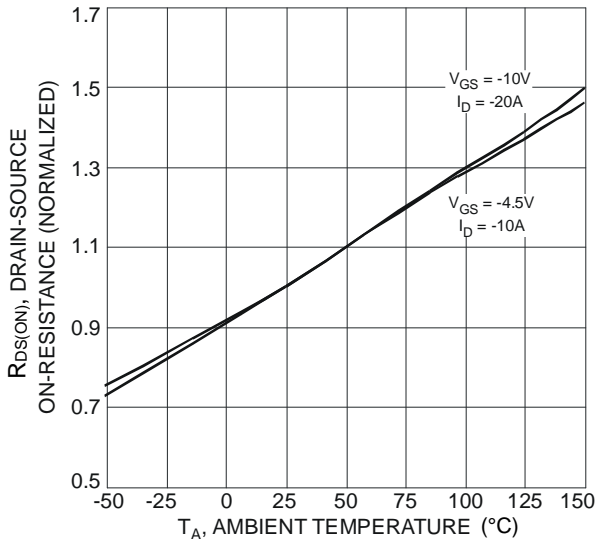


Fig. 16 On-Resistance Variation with Temperature

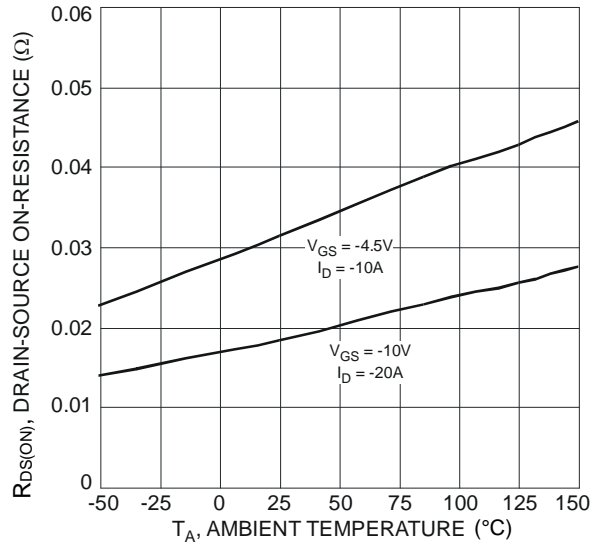


Fig. 17 On-Resistance Variation with Temperature

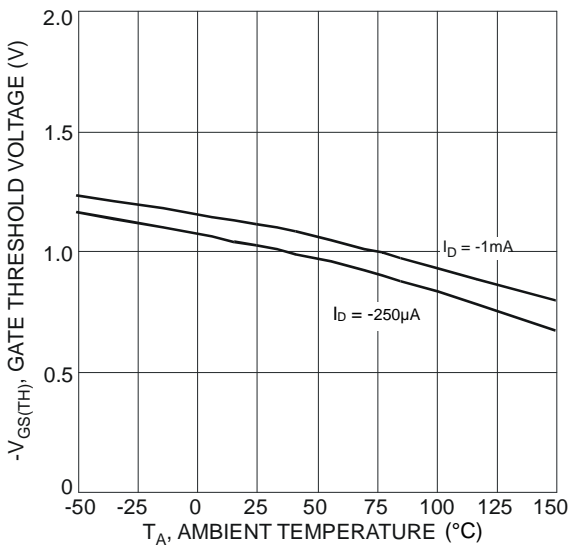


Fig. 18 Gate Threshold Variation vs. Ambient Temperature

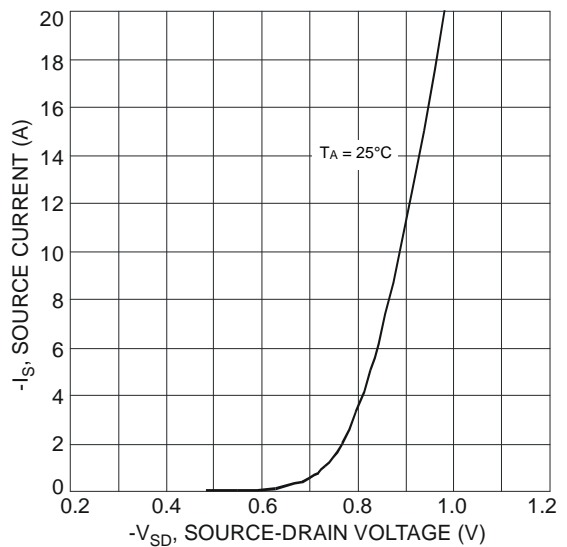


Fig. 19 Diode Forward Voltage vs. Current



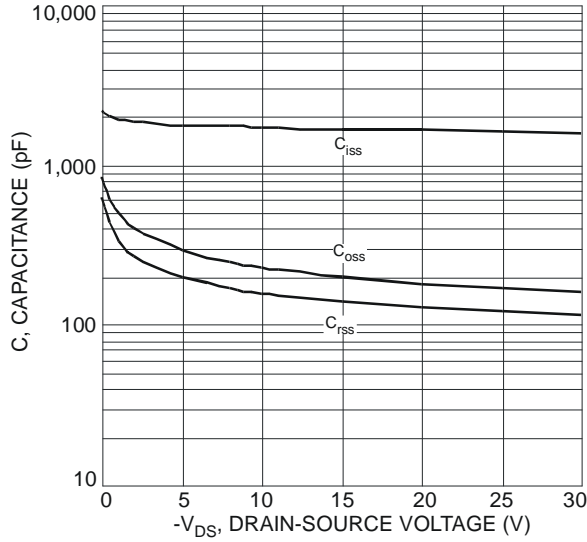


Fig. 20 Typical Total Capacitance

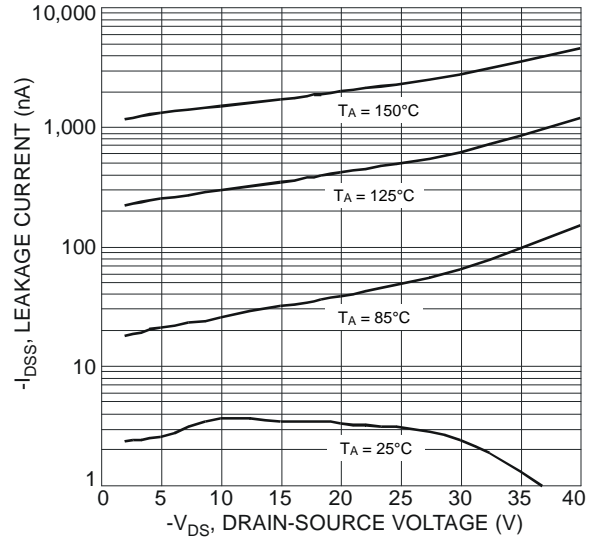


Fig. 21 Typical Leakage Current vs. Drain-Source Voltage

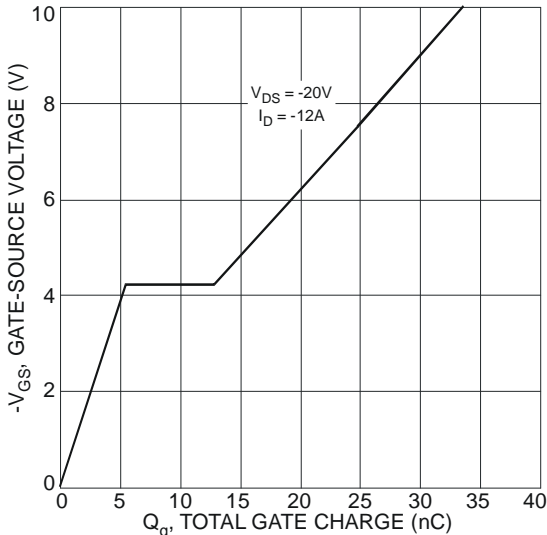
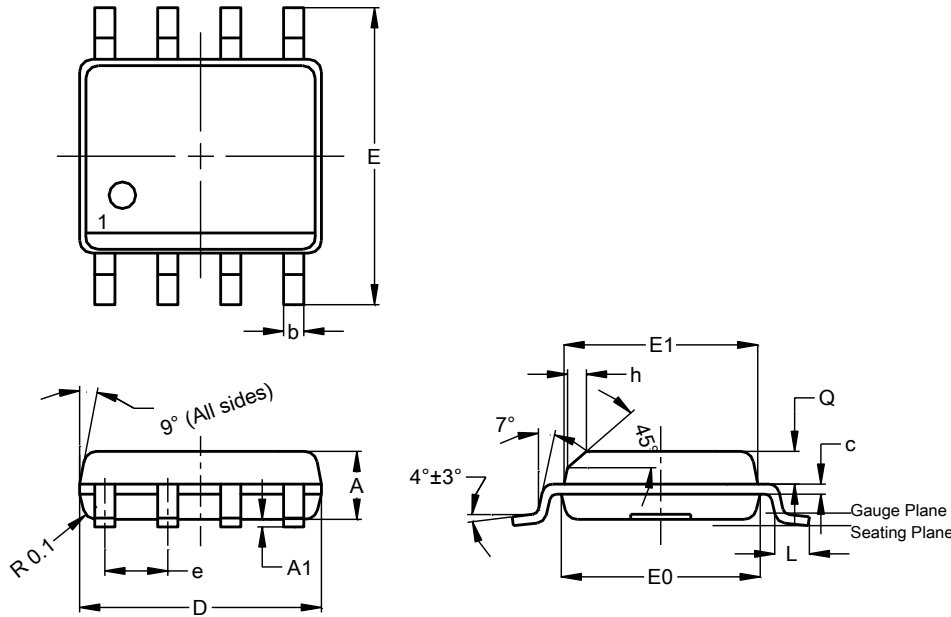


Fig. 22 Gate-Charge Characteristics

**Package Outline Dimensions**

Please see <http://www.diodes.com/package-outlines.html> for the latest version.

SO-8

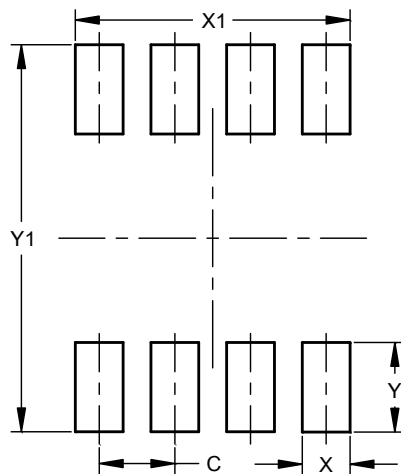


SO-8			
Dim	Min	Max	Typ
A	1.40	1.50	1.45
A1	0.10	0.20	0.15
b	0.30	0.50	0.40
c	0.15	0.25	0.20
D	4.85	4.95	4.90
E	5.90	6.10	6.00
E1	3.80	3.90	3.85
E0	3.85	3.95	3.90
e	--	--	1.27
h	-	--	0.35
L	0.62	0.82	0.72
Q	0.60	0.70	0.65
All Dimensions in mm			

**Suggested Pad Layout**

Please see <http://www.diodes.com/package-outlines.html> for the latest version.

SO-8



Dimensions	Value (in mm)
C	1.27
X	0.802
X1	4.612
Y	1.505
Y1	6.50

**IMPORTANT NOTICE**

1. DIODES INCORPORATED (Diodes) AND ITS SUBSIDIARIES MAKE NO WARRANTY OF ANY KIND, EXPRESS OR IMPLIED, WITH REGARDS TO ANY INFORMATION CONTAINED IN THIS DOCUMENT, INCLUDING, BUT NOT LIMITED TO, THE IMPLIED WARRANTIES OF MERCHANTABILITY, FITNESS FOR A PARTICULAR PURPOSE OR NON-INFRINGEMENT OF THIRD PARTY INTELLECTUAL PROPERTY RIGHTS (AND THEIR EQUIVALENTS UNDER THE LAWS OF ANY JURISDICTION).
2. The Information contained herein is for informational purpose only and is provided only to illustrate the operation of Diodes' products described herein and application examples. Diodes does not assume any liability arising out of the application or use of this document or any product described herein. This document is intended for skilled and technically trained engineering customers and users who design with Diodes' products. Diodes' products may be used to facilitate safety-related applications; however, in all instances customers and users are responsible for (a) selecting the appropriate Diodes products for their applications, (b) evaluating the suitability of Diodes' products for their intended applications, (c) ensuring their applications, which incorporate Diodes' products, comply the applicable legal and regulatory requirements as well as safety and functional-safety related standards, and (d) ensuring they design with appropriate safeguards (including testing, validation, quality control techniques, redundancy, malfunction prevention, and appropriate treatment for aging degradation) to minimize the risks associated with their applications.
3. Diodes assumes no liability for any application-related information, support, assistance or feedback that may be provided by Diodes from time to time. Any customer or user of this document or products described herein will assume all risks and liabilities associated with such use, and will hold Diodes and all companies whose products are represented herein or on Diodes' websites, harmless against all damages and liabilities.
4. Products described herein may be covered by one or more United States, international or foreign patents and pending patent applications. Product names and markings noted herein may also be covered by one or more United States, international or foreign trademarks and trademark applications. Diodes does not convey any license under any of its intellectual property rights or the rights of any third parties (including third parties whose products and services may be described in this document or on Diodes' website) under this document.
5. Diodes' products are provided subject to Diodes' Standard Terms and Conditions of Sale (<https://www.diodes.com/about/company/terms-and-conditions/terms-and-conditions-of-sales/>) or other applicable terms. This document does not alter or expand the applicable warranties provided by Diodes. Diodes does not warrant or accept any liability whatsoever in respect of any products purchased through unauthorized sales channel.
6. Diodes' products and technology may not be used for or incorporated into any products or systems whose manufacture, use or sale is prohibited under any applicable laws and regulations. Should customers or users use Diodes' products in contravention of any applicable laws or regulations, or for any unintended or unauthorized application, customers and users will (a) be solely responsible for any damages, losses or penalties arising in connection therewith or as a result thereof, and (b) indemnify and hold Diodes and its representatives and agents harmless against any and all claims, damages, expenses, and attorney fees arising out of, directly or indirectly, any claim relating to any noncompliance with the applicable laws and regulations, as well as any unintended or unauthorized application.
7. While efforts have been made to ensure the information contained in this document is accurate, complete and current, it may contain technical inaccuracies, omissions and typographical errors. Diodes does not warrant that information contained in this document is error-free and Diodes is under no obligation to update or otherwise correct this information. Notwithstanding the foregoing, Diodes reserves the right to make modifications, enhancements, improvements, corrections or other changes without further notice to this document and any product described herein. This document is written in English but may be translated into multiple languages for reference. Only the English version of this document is the final and determinative format released by Diodes.
8. Any unauthorized copying, modification, distribution, transmission, display or other use of this document (or any portion hereof) is prohibited. Diodes assumes no responsibility for any losses incurred by the customers or users or any third parties arising from any such unauthorized use.
9. This Notice may be periodically updated with the most recent version available at <https://www.diodes.com/about/company/terms-and-conditions/important-notice>

The Diodes logo is a registered trademark of Diodes Incorporated in the United States and other countries.  
All other trademarks are the property of their respective owners.  
© 2023 Diodes Incorporated. All Rights Reserved.

[www.diodes.com](http://www.diodes.com)