

Features

- Wide input voltage range: 1.9V – 5.5V
- Low dropout voltage: 100mV at 100mA output current
- Very low quiescent current (Iq): 25uA typical
- Fixed output voltage: 1.0V to 3.3V
- Up to 150mA per output channel
- Very fast transient response
- High PSRR: 78dB at 1kHz
- Accurate voltage regulation
- 300mA current limiting
- Thermal shutdown protection
- Ambient temperature range -40°C to 85°C
- Package available: DFN2018-6 (USP-6B)
- DFN2018-6 (USP-6B): Available in “Green” Molding Compound (No Br, Sb)
- Lead Free Finish / RoHS Compliant (Note 1)

General Description

The AP7201 is a dual low-dropout (LDO) CMOS linear regulator. The device operates from 1.9V to 5.5V input and delivers up to 150mA per output channel.

The AP7201 includes a pass element, voltage reference, error amplifier, current limit and built-in phase compensation. Key features include individual logic-compatible enable/shutdown control inputs, fold-back current limit and thermal shutdown protections.

The AP7201 is fully compatible with low ESR ceramic capacitors, reducing cost and improving output stability. The fixed output voltage for each channel is set independently. Voltages are 100mV per step within a range of 1.0V to 3.3V.

The EN function allows the output of each channel to be turned off independently, resulting in greatly reduced power consumption. The AP7201 is available in the DFN2018-6 (USP-6B) package.

Applications

- Cell Phones
- Smart Phones and PDA
- MP3/MP4
- PMP
- Bluetooth Headsets
- Digital Still Cameras
- GPS

Ordering Information

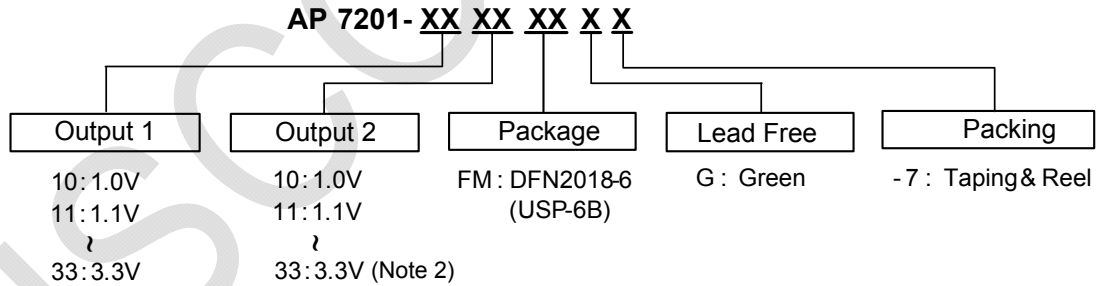

Device	Pb-Free or Green	Package Code	Packaging (Note 3)	7" Tape and Reel	
				Quantity	Part Number Suffix
AP7201-1818FMG-7		FM	DFN2018-6 (USP-6B)	3000/Tape & Reel	-7
AP7201-1828FMG-7		FM	DFN2018-6 (USP-6B)	3000/Tape & Reel	-7
AP7201-2828FMG-7		FM	DFN2018-6 (USP-6B)	3000/Tape & Reel	-7

- Notes:
1. RoHS revision 13.2.2003. Glass and high temperature solder exemptions applied, see *EU Directive Annex Notes 5 and 7*.
 2. Diodes, Inc. offers custom laser trimming for additional Fixed output voltage combinations from 1.0V to 3.3V. For output voltage availability, please contact your local Diodes, Inc. sales representative.
 3. Pad layout as shown on Diodes Inc. suggested pad layout document AP02001, which can be found on our website at <http://www.diodes.com/datasheets/ap02001.pdf>.

Pin Assignments

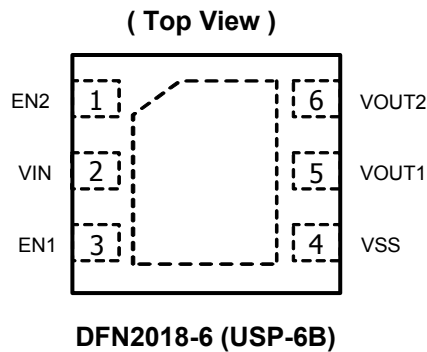

Pin Descriptions

Pin Name	Pin Number	Function
EN2	1	Enable input 2 (Active High)
VIN	2	Voltage input pin. Bypass to ground through at least 0.22μF ceramic capacitor.
EN1	3	Enable input 1 (Active High)
GND (VSS)	4	Ground
OUT1	5	Voltage output 1. Bypass to ground through at least 0.22μF ceramic capacitor.
OUT2	6	Voltage output 2. Bypass to ground through at least 0.22μF ceramic capacitor.

Typical Application Circuits

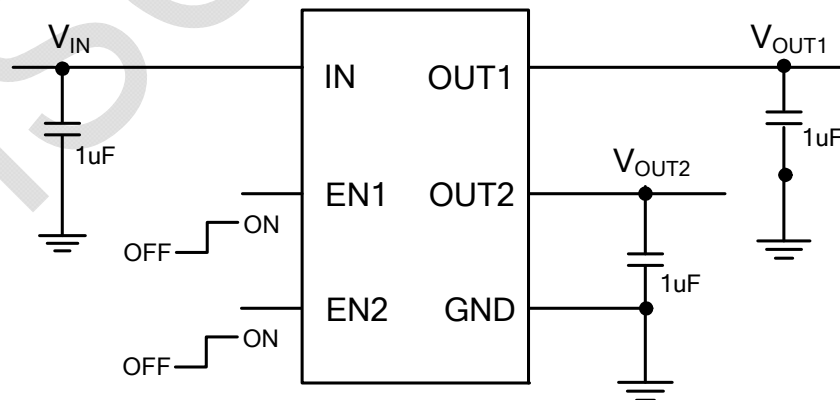

Absolute Maximum Ratings

Symbol	Description	Rating	Unit
ESD HBM	Human Body Model ESD Protection	4	KV
ESD MM	Machine Model ESD Protection	250	V
Ven1 _{MAX}	Enable 1 Voltage	V _{IN} + 0.3	V
Ven2 _{MAX}	Enable 2 Voltage	V _{IN} + 0.3	V
Vout1 _{MAX}	Output 1 Voltage	V _{IN} + 0.3	V
Vout2 _{MAX}	Output 2 Voltage	V _{IN} + 0.3	V
V _{IN} MAX	Input Voltage	6.5	V
I _{OUT} MAX	Continuous Load Current per Channel	150	mA
T _{LEAD}	Lead Temperature	260	°C
T _{ST}	Storage Temperature	-65 to 150	°C
T _J	Maximum Junction Temperature	150	°C
P _D MAX	Power Dissipation (Notes 4, 5, 6) DFN2018-6 (USP-6B)	1700	mW

Notes: 4. T_J, max = 150°C.
5. Ratings apply to ambient temperature at 25°C.

Recommended Operating Conditions

Symbol	Description	Min	Max	Unit
V _{IN}	Input Voltage	1.9	5.5	V
I _{OUT}	Output Current per Channel	0	150	mA
T _A	Operating Ambient Temperature	-40	85	°C

Electrical Characteristics

 ($T_A = 25^\circ\text{C}$, $V_{IN} = V_{EN}$, $C_{IN} = 1\mu\text{F}$, $C_{OUT} = 1\mu\text{F}$ unless otherwise stated)

Symbol	Parameter	Test Conditions	Min	Typ.	Max	Unit
V_{IN}	Operation Input Voltage Range		1.9		5.5	V
I_Q	Input Quiescent Current	$I_{OUT} = 0$	—	25	45	μA
$I_{Q(OFF)}$	Input Shutdown Current	$V_{EN} = 0\text{V}$	—		1	μA
$I_{LK(OFF)}$	Input Leakage Current	$V_{EN} = 0\text{V}$, OUT grounded	—		1	μA
$V_{Dropout}$	Dropout Voltage	$V_{OUT} = 1.8\text{V}$, $I_{OUT} = 100\text{mA}$		170	220	mV
$V_{Dropout}$		$V_{OUT} = 3.3\text{V}$, $I_{OUT} = 100\text{mA}$		100	150	mV
V_{OUT}	Output Voltage Accuracy		-2		2	%
$\frac{\Delta V_{OUT}}{\Delta V_{IN}} \bigg _{V_{OUT}}$	Line Regulation	$V_{IN} = V_{OUT} + 0.2\text{V}$ ($V_{IN} > 1.9\text{V}$) to 5.0V , $I_{OUT} = 1\text{mA}$		0.01	0.2	%/V
ΔV_{OUT}	Load Regulation	I_{OUT} from 1mA to 100mA		5	30	mV
t_{ST}	Start-up Time	$V_{EN} = 0\text{V}$ to 2.0V , $I_{OUT} = 150\text{mA}$		50		μs
PSRR	PSRR	1kHz, $I_{OUT} = 30\text{mA}$		78		dB
I_{SHORT}	Short-circuit Current	$V_{IN} = 5.0\text{V}$, $V_{OUT} < 0.2\text{V}$		40		mA
I_{LIMIT}	Current Limit	$V_{IN} = V_{OUT} + 1.0\text{V}$		300		mA
V_{IL}	EN Input Logic Low Voltage				0.25	V
V_{IH}	EN Input Logic High Voltage		1.6			V
I_{EN}	EN Input Leakage	$V_{EN} = 0\text{V}$ or V_{in}	—		0.1	μA
T_{SHDN}	Thermal Shutdown Threshold			145		$^\circ\text{C}$
T_{HYS}	Thermal Shutdown Hysteresis			15		$^\circ\text{C}$
θ_{JA}	Thermal Resistance Junction-to-Ambient (Note 6)	DFN2018-6		70		$^\circ\text{C}/\text{W}$

Notes: 6. Test condition for DFN2018-6: Device mounted on FR-4 2-layer board, 2oz copper, with minimum recommended pad on top layer and 3 vias to bottom layer 1.0"x1.4" ground plane.

Typical Performance Characteristics

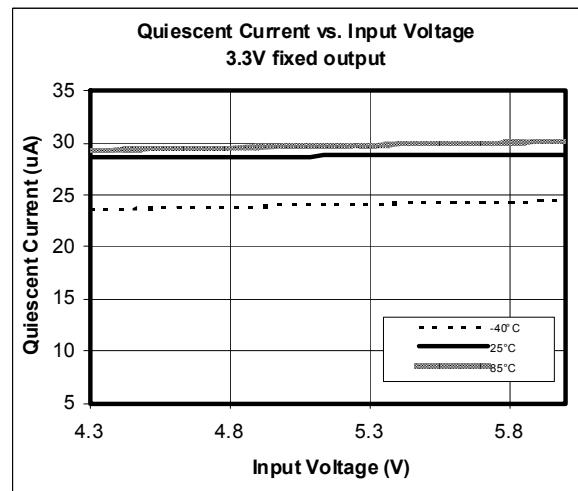
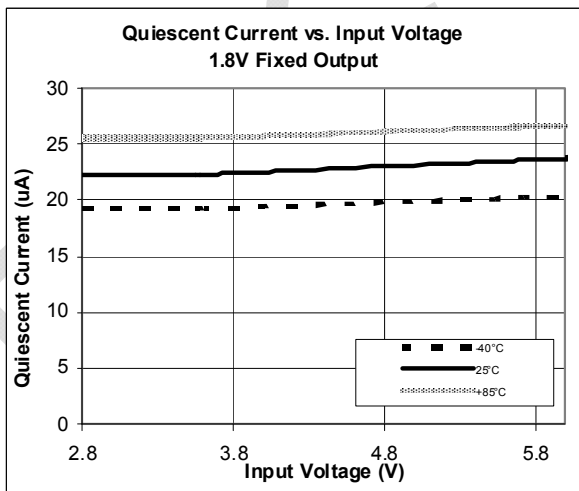
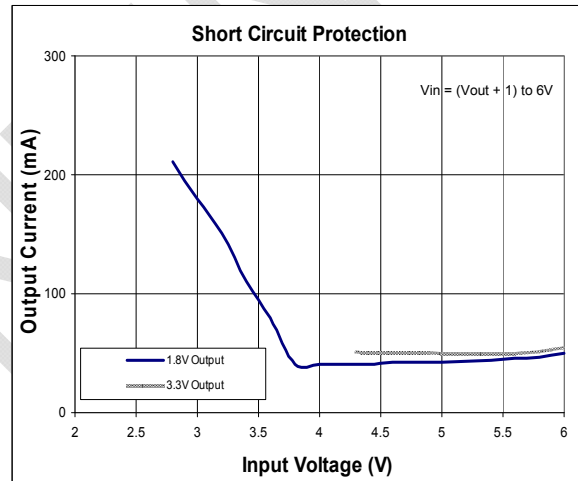
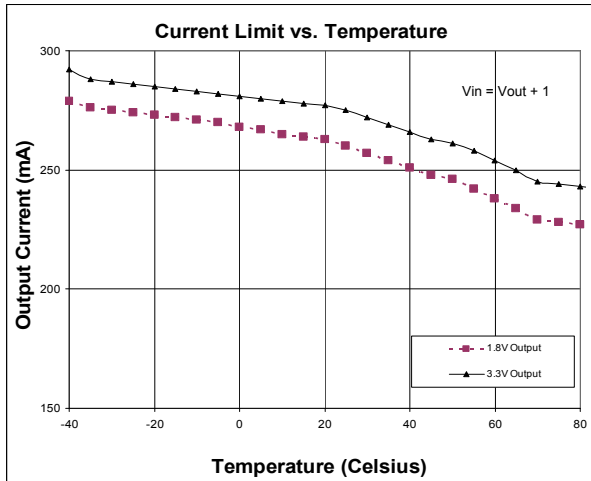
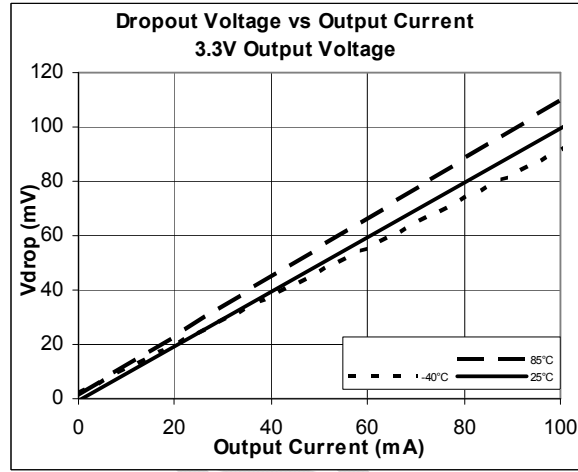
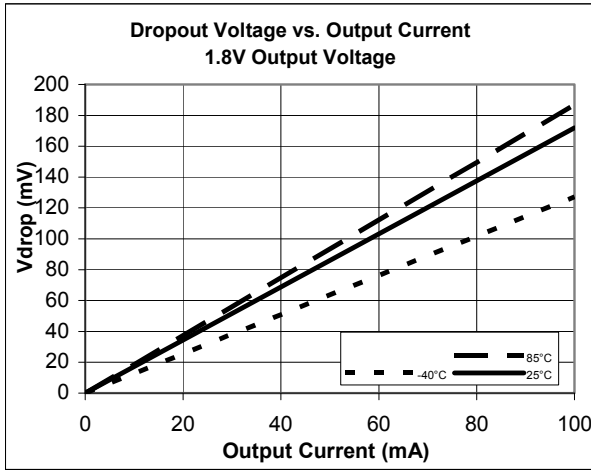

Typical Performance Characteristics (Continued)

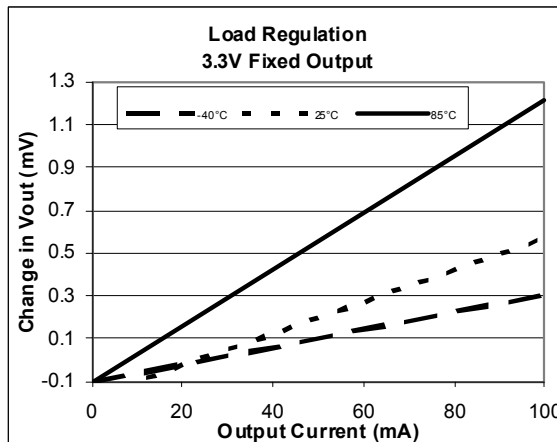
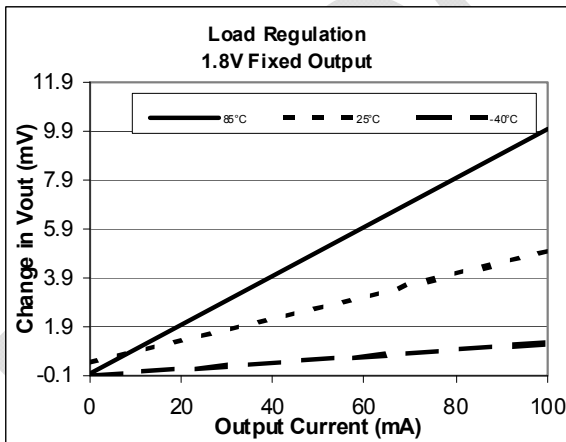
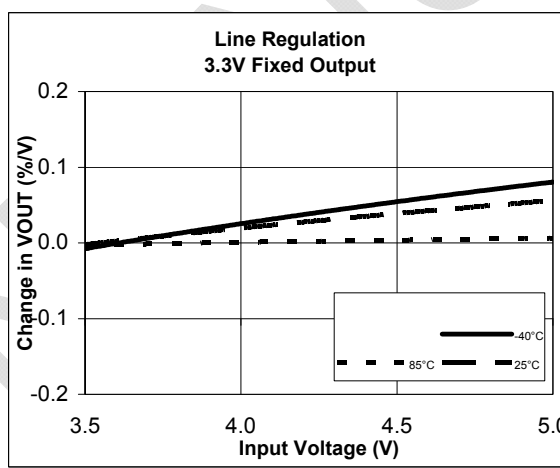
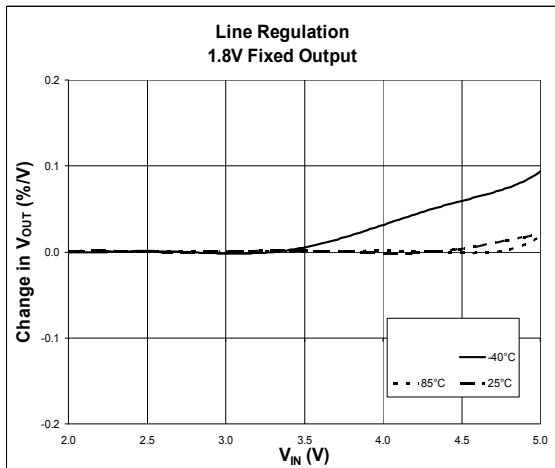
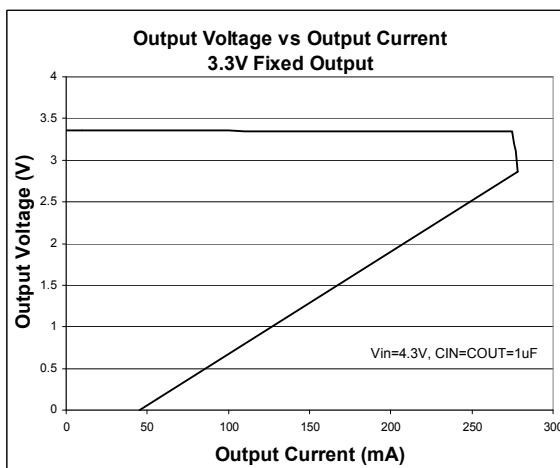
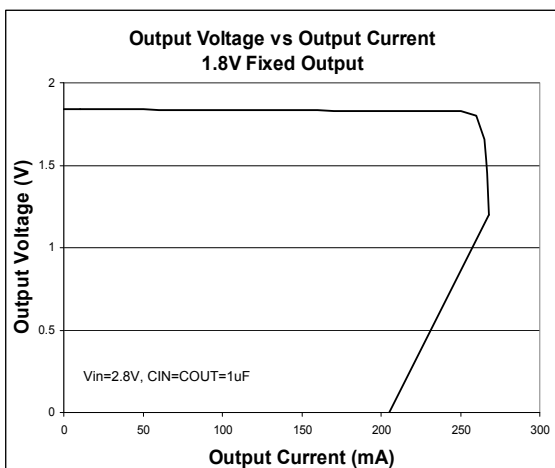

Typical Performance Characteristics (Continued)

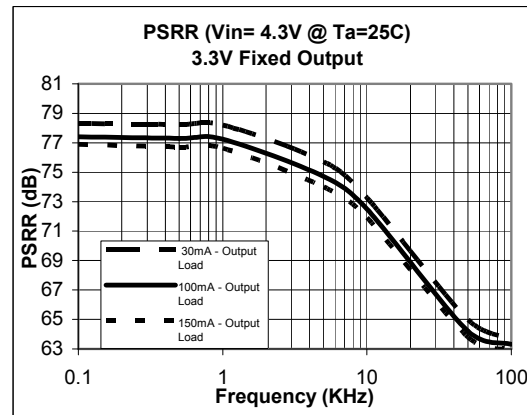
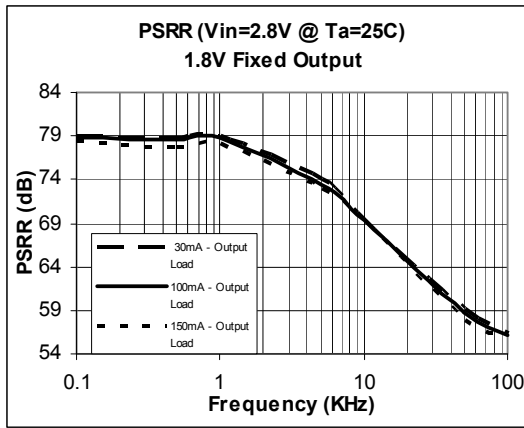

Start-up Time (Vout=3.3V, Iout=0mA)

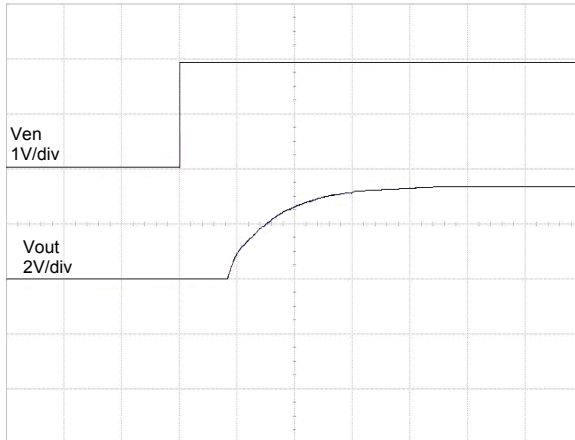

Time (20us/div)

Start-up Time (Vout=3.3V, Iout=150mA)

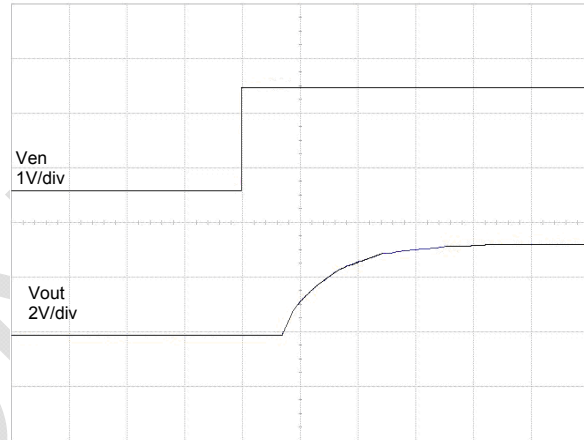

Time (20us/div)

Current Limit Protection (Vout=3.3V)

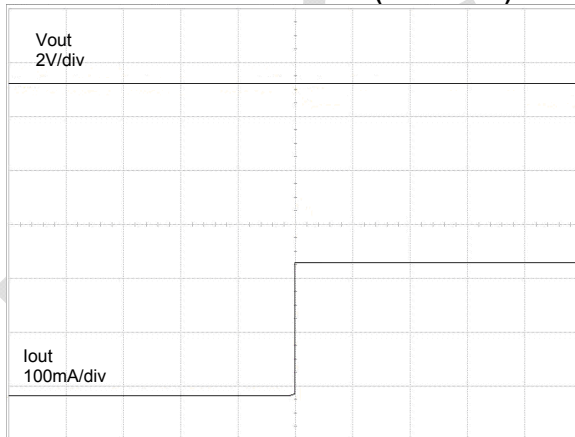

Time (50us/div)

Short Circuit Protection (Vout=3.3V)

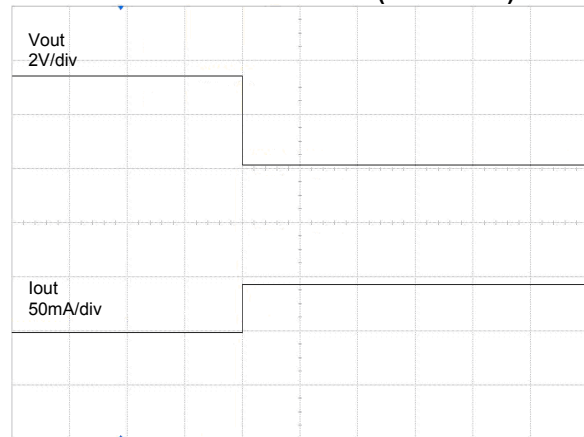

Time (1ms/div)

Typical Performance Characteristics (Continued)

Line Transient Response

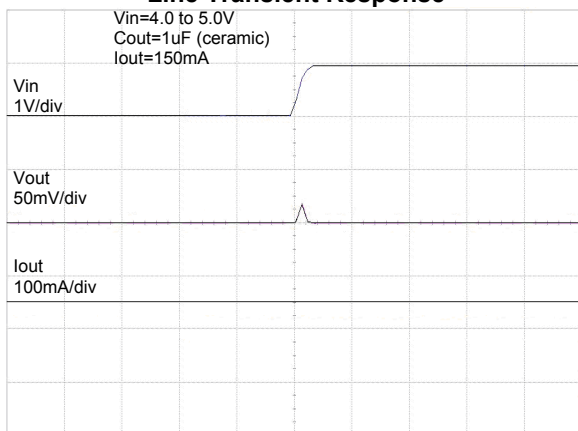

Time (20 $\mu s/div$)

Line Transient Response

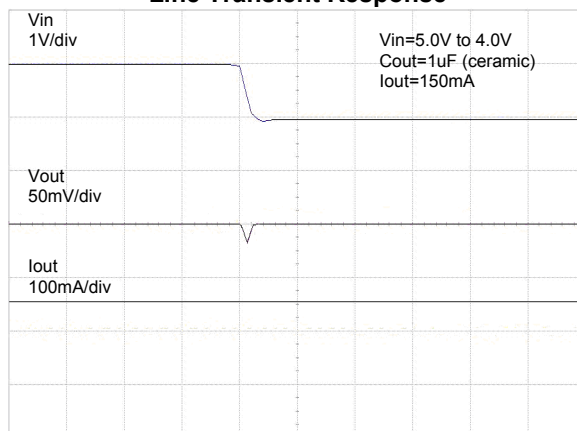

Time (20 $\mu s/div$)

Output Load Transient Response (Vout=1.0V)

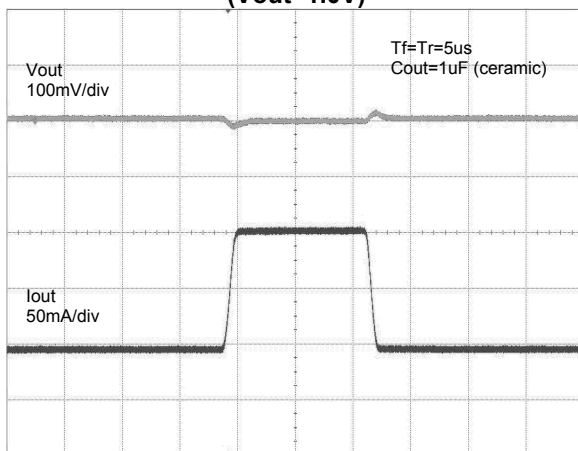

Time (40 $\mu s/div$)

Output Load Transient Response (Vout=1.8V)

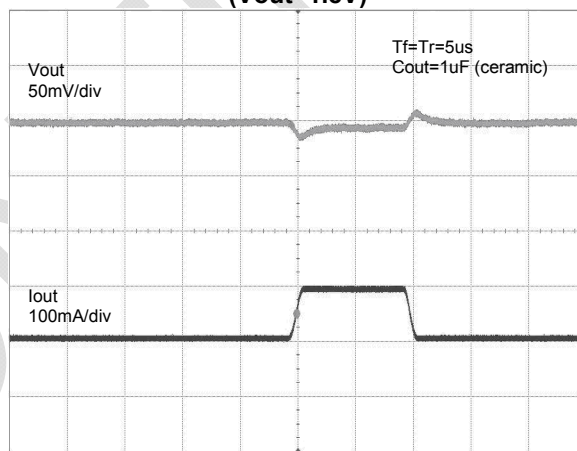

Time (40 $\mu s/div$)

Typical Performance Characteristics (Continued)

**Output Load Transient Response
(Vout=2.8V)**

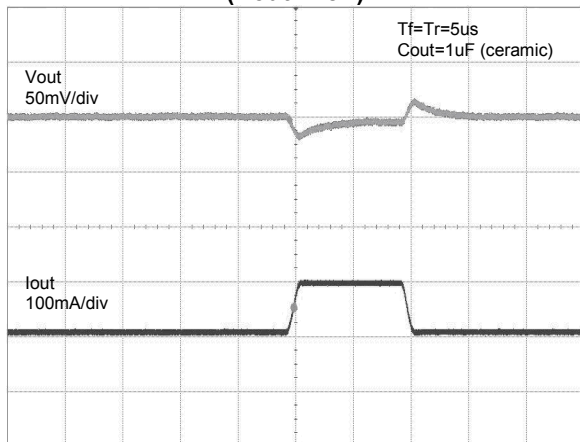

Time (40us/div)

**Output Load Transient Response
(Vout=3.0V)**

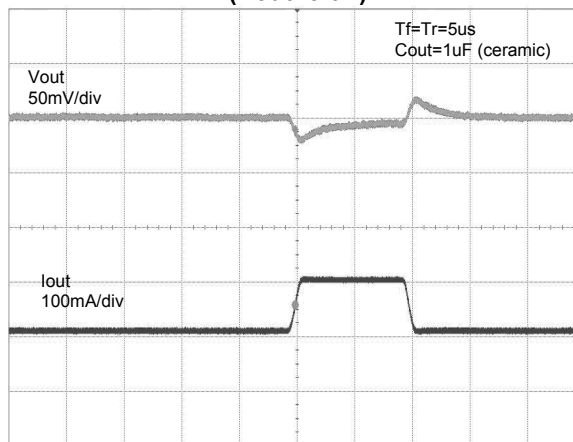

Time (40us/div)

**Output Load Transient Response
(Vout=3.3V)**

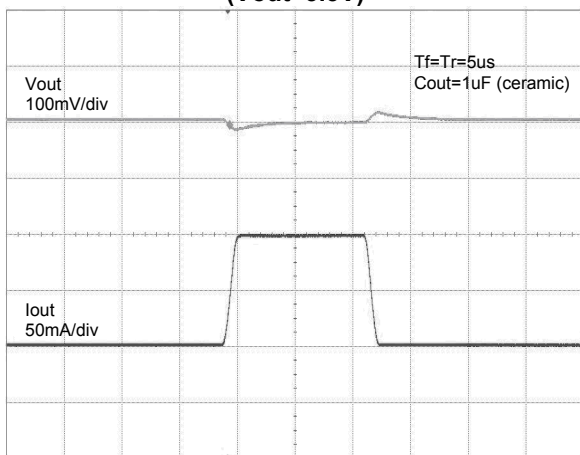

Time (40us/div)

Application Note

Input Capacitor

AP7201 requires a minimum input capacitance of 0.22 μ F ceramic capacitor between VIN and GND pins to prevent any impedance interactions with the supply. This input capacitor should be located as close as possible to the device to assure input stability and less noise. For PCB layout, a wide copper trace is required for both IN and GND.

Output Capacitor

AP7201 requires a minimum of 0.22 μ F capacitance on each output to stabilize the transient response of the LDO. The AP7201 is designed to have excellent transient response for most applications with a small amount of output capacitance. A ceramic capacitor is recommended on each channel to connect between OUT and GND pins. The device is also stable with multiple capacitors in parallel, which can be of any type of value. Larger capacitance helps to reduce undershoot and overshoot during transient and provides better stability and noise performance. This output capacitor should be placed as close as possible to OUT and GND pins for optimum performance.

No Load Stability

Other than external resistor divider, no minimum load is required to keep the device stable. The device will remain stable and regulated in no load condition.

ENABLE/SHUTDOWN Operation

The AP7201 is turned on by setting the EN pin high by pulling to input voltage (VIN), and is turned off by pulling it low (GND). The EN function allows the output of each regulator to be turned off independently, resulting in greatly reduced power consumption. The EN pin should be tied to VIN pin to keep the regulator output on at all time. To ensure proper operation, the signal source used to drive the EN pin must be able to swing above and below the specified turn-on/off voltage thresholds listed in the Electrical Characteristics section under V_{IL} and V_{IH} .

Current Limit Protection

In the presence of a short or excessive load current condition, the AP7201 uses an internal short circuit fold-back mechanism that triggers the current limit protection and clamps the output current to approximately 300mA.

Short Circuit Protection

When OUT pin is short-circuited to GND or OUT pin voltage is less than 200mV, short circuit protection will be triggered and clamp the output current to approximately 40mA typical. This feature protects the regulator from over-current and damage due to overheating.

Application Note (Continued)

Wide Fixed Output Range

The AP7201, with a wide fixed output range of 1V to 3.3V, provides a versatile solution for many portable and low power applications.

Low Quiescent Current

The AP7201, consuming only around 25µA for all input range, provides great power saving in portable and low power applications.

Thermal Shutdown Protection

Thermal protection disables both outputs when the junction temperature rises to approximately +145°C, allowing the device to cool down. When the junction temperature reduces to approximately +130°C the output circuitry is enabled again. Depending on power dissipation, thermal resistance, and ambient temperature, the thermal protection circuit may cycle on and off. This cycling limits the heat dissipation of the regulator, protecting it from damage due to overheating.

Power Dissipation

The device power dissipation and proper sizing of the thermal plane that is connected to the thermal pad is critical to avoid thermal shutdown and ensure reliable operation. Power dissipation of the device depends on input voltage and load conditions and can be calculated by:

$$P_D = (V_{IN} - V_{OUT}) \times I_{OUT}$$

The AP7201 is available in the DFN2818-6 package with exposed pad, which is the primary conduction path for heat to the printed circuit board (PCB). The pad can be connected to ground or be left floating; however, to ensure the device will not overheat, it should be attached to an appropriate amount of copper PCB area.

The maximum power dissipation, handled by the device, depends on the maximum junction to ambient thermal resistance, maximum ambient temperature, and maximum device junction temperature, which can be calculated by the equation in the following:

$$P_D(\text{max}@T_A) = \frac{(+145^\circ\text{C} - T_A)}{R_{\theta JA}}$$

Marking Information

(1) DFN2018-6 (USP-6B)

(Top View)

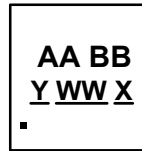

AA : Output 1
 BB : Output 2
 Y : Year "7" : 2007
 "8" : 2008
 WW : Month 01~52
 X : G : Green

Marking ID Code Table

Device	ID Code
AP7201-1818FM	1818
AP7201-1828FM	1828
AP7201-2828FM	2828

Package Information (All Dimensions in mm)

(1) DFN2018-6 (USP-6B)

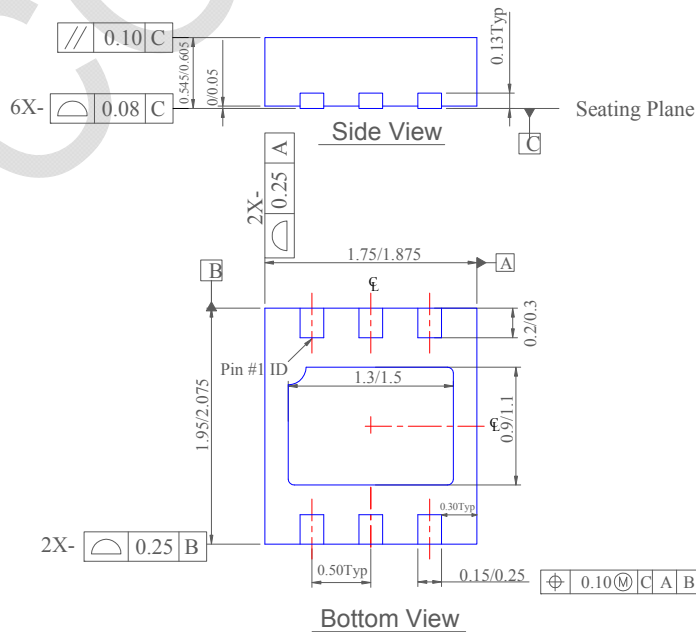

Taping Orientation (Note 7)

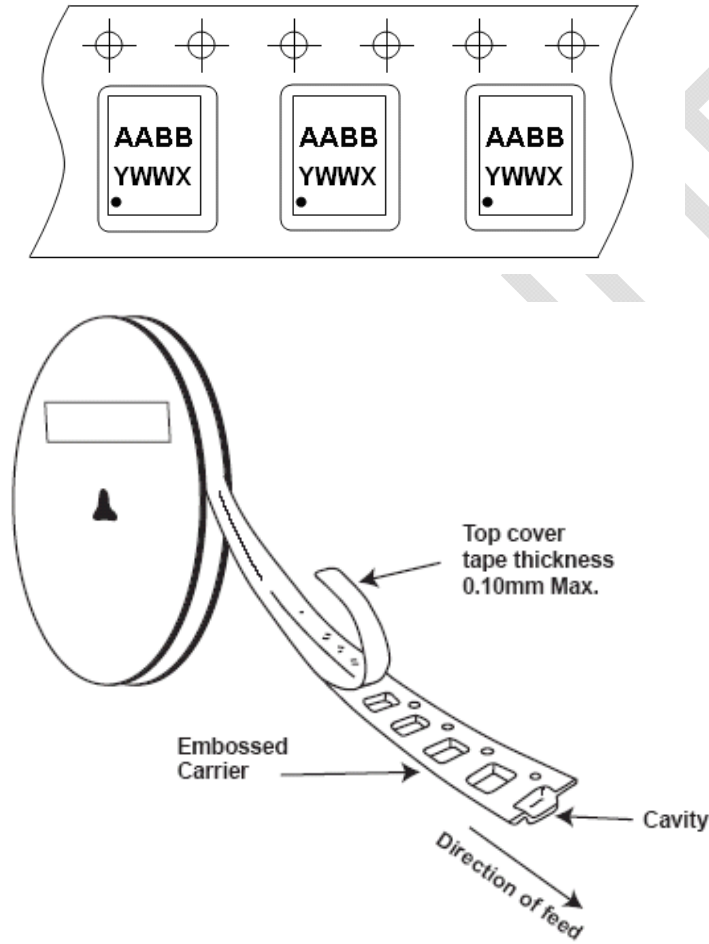

Notes: 7. The taping orientation of the other package type can be found on our website at <http://www.diodes.com/datasheets/ap02007.pdf>

IMPORTANT NOTICE

Diodes Incorporated and its subsidiaries reserve the right to make modifications, enhancements, improvements, corrections or other changes without further notice to any product herein. Diodes Incorporated does not assume any liability arising out of the application or use of any product described herein; neither does it convey any license under its patent rights, nor the rights of others. The user of products in such applications shall assume all risks of such use and will agree to hold Diodes Incorporated and all the companies whose products are represented on our website, harmless against all damages.

LIFE SUPPORT

Diodes Incorporated products are not authorized for use as critical components in life support devices or systems without the expressed written approval of the President of Diodes Incorporated.