

## Description

The AH8503 is a high accuracy, micropower linear Hall-effect sensor with an 8-bit output resolution. The output voltage is ratiometric to the supply voltage and proportional to the magnetic flux density perpendicular to the part marking surface. The output null voltage is at half the supply voltage.

AH8503 is a trimmed device with typical sensitivity of 2.25mV/G and 3.8mV/G at 1.8V and 3V respectively with an accuracy of 3% at +25°C. The device has a typical input referred rms noise of 0.36G and 0.24G at 1.8V and 3.0V.

Designed for battery powered consumer equipment to office equipment, home appliances and industrial applications, the AH8503 can operate over the supply range of 1.6V to 3.6V. The device has a CNTRL pin to select the operating modes and sampling rate to minimize power consumption. The device operates in default micropower mode with a sampling rate of 24Hz typical and consumes only 13µA typical at 1.8V. In turbo mode with a continuous 6.25kHz sample rate, the current consumption is 1mA typical. In external-drive mode, the CNTRL can be used to change the sampling frequency up to 7.14kHz with current consumption of 1.16mA typical at 1.8V.

To minimize PCB space the AH8503 is available in small low profile U-DFN2020-6 (Type C) package.

## Features

- High Accuracy Linear Hall-Effect Sensor with +/-400G Sense Range and Output Voltage with 8-Bit Resolution
- Supply Voltage of 1.6V to 3.6V
- High Accuracy: Trimmed Sensitivity of 2.225mV/G and 3.8mV/G at 1.8V and 3V Respectively with Accuracy of 3% at +25°C
- Low Offset Voltage
- Micropower (Default), Turbo and External-Drive Modes
- Ultra Low Average Supply Current
  - 13µA Typical in Micropower Mode (Default) Period at 1.8V
  - 1.01mA Typical in Turbo Mode at 1.8V
  - 1.16mA Typical in External-Drive Mode with 7.14kHz Sampling Rate at 1.8V
- Chopper Stabilized Design with Superior Temperature Stability, Minimal Sensitivity Drift, Enhanced Immunity to Physical Stress
- Output Voltage Maintained at 'Sleep' Mode
- -40°C to +85°C Operating Temperature
- High ESD Capability of 6kV Human Body Model
- Small Low Profile U-DFN2020-6 (Type C) Package
- **Totally Lead-Free & Fully RoHS Compliant (Notes 1 & 2)**
- **Halogen and Antimony Free. "Green" Device (Note 3)**
- **For automotive applications requiring specific change control (i.e. parts qualified to AEC-Q100/101/104/200, PPAP capable, and manufactured in IATF 16949 certified facilities), please [contact us](https://www.diodes.com/quality/product-definitions/) or your local Diodes representative.**

<https://www.diodes.com/quality/product-definitions/>

- Notes:
1. No purposely added lead. Fully EU Directive 2002/95/EC (RoHS), 2011/65/EU (RoHS 2) & 2015/863/EU (RoHS 3) compliant.
  2. See <https://www.diodes.com/quality/lead-free/> for more information about Diodes Incorporated's definitions of Halogen- and Antimony-free, "Green" and Lead-free.
  3. Halogen- and Antimony-free "Green" products are defined as those which contain <900ppm bromine, <900ppm chlorine (<1500ppm total Br + Cl) and <1000ppm antimony compounds.

## Pin Assignments

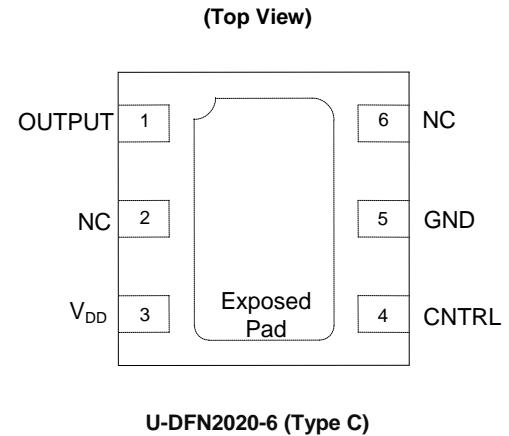

## Applications

- High accuracy level, proximity, position and travel detection
- Button press detection in digital still, video cameras and handheld gaming consoles
- Accurate door, lids and tray position detection
- Liquid level detection
- Joy stick controls – gaming and industrial applications
- Smart meters
- Contactless level, proximity and position measurement in home appliances and industrial applications

## Typical Applications Circuit

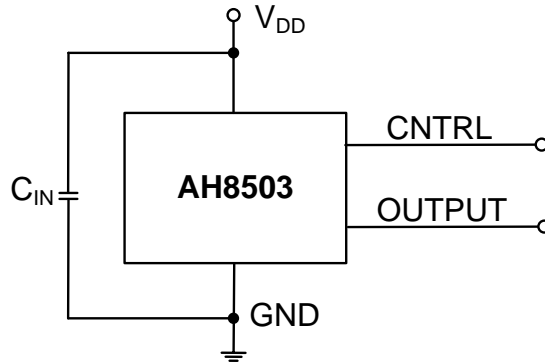

Note: 4.  $C_{IN}$  is for power stabilization and to strengthen the noise immunity, the recommended capacitance is 100nF typical and should be placed as close to the supply pin as possible.

## Pin Descriptions

Package: U-DFN2020-6 (Type C)

Pin Number	Pin Name	Function
1	OUTPUT	Output Pin
2	NC	No Connection (Note 5)
3	V <sub>DD</sub>	Power Supply Input
4	CNTRL	<p>Device Control Pin: The CNTRL pin selects the modes of operation (Micropower Mode, Turbo Mode and External-Drive Mode) and adjusts the sampling rate in External-Drive Mode to minimize the power consumption.</p> <p>When CNTRL = GND or floating, the device operates in default Micropower Mode with 24Hz sampling rate and consumes 13<math>\mu</math>A typical at 1.8V. The CNTRL pin is internally pulled low.</p> <p>When CNTRL = V<sub>DD</sub>, the device is on and operates in Turbo Mode with continuous sampling rate of 6.25kHz typical consuming 1.01mA typical at 1.8V</p> <p>In External-Drive Mode, an external PWM signal can be used to drive the CNTRL pin to adjust the sampling frequency from 24Hz typical up to 7.14kHz typical. If external PWM pulse is used, the minimum pulse width needed on the CNTRL pin to start a sample/conversion is 20<math>\mu</math>s typical. We recommended using a pulse width of 40<math>\mu</math>s minimum. The minimum sample and conversion cycle is 140<math>\mu</math>s typical.</p>
5	GND	Ground Pin
6	NC	No Connection (Note 5)
—	Exposed Pad	The center exposed pad – No connection internally. The exposed pad can be left open (unconnected) or tied to the GND on the PCB layout.

Note: 5. NC is "No Connection" pin and is not connected internally. This pin can be left open or tied to ground.

## Functional Block Diagram

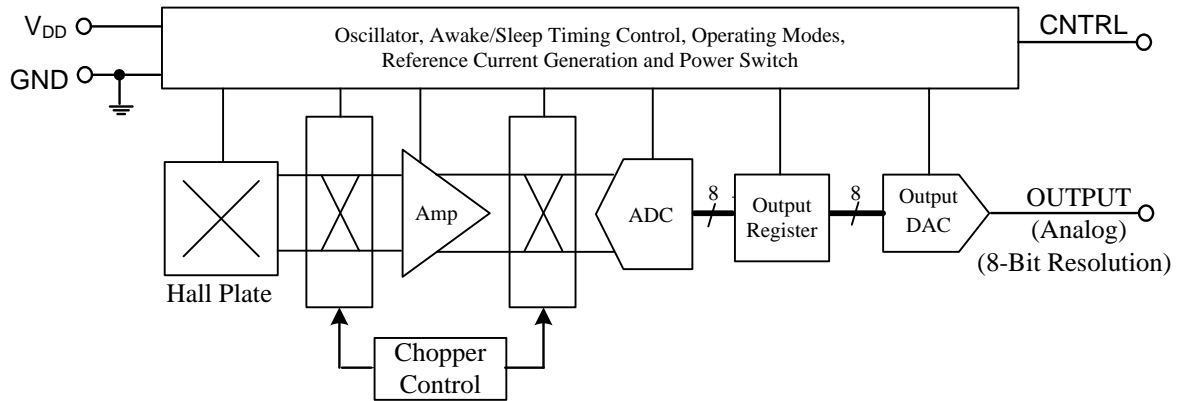

## Absolute Maximum Ratings (Note 6) (@T<sub>A</sub> = +25°C, unless otherwise specified.)

Symbol	Parameter	Rating	Unit
V <sub>DD</sub> and V <sub>OUT</sub>	Supply Voltage and Output Voltage (Note 7)	4	V
V <sub>DD_REV</sub> and V <sub>OUT_REV</sub>	Reverse Supply and Output Voltage	-0.3	V
I <sub>OUT</sub>	Output Current (Limited by 10k Ohms Output Resistor)	V <sub>DD</sub> /10	mA
B	Magnetic Flux Density Withstand	Unlimited	
P <sub>D</sub>	Package Power Dissipation	U-DFN2020-6 (Type C)	230 mW
T <sub>s</sub>	Storage Temperature Range	-65 to +150	°C
T <sub>J</sub>	Maximum Junction Temperature	+150	°C
ESD HBM	Human Body Model (HBM) ESD Capability	6	kV

- Notes:
- Stresses greater than those listed under *Absolute Maximum Ratings* can cause permanent damage to the device. These are stress ratings only, and functional operation of the device at these or any other conditions beyond those indicated under *Recommended Operating Conditions* is not implied. Exposure to *Absolute Maximum Ratings* for extended periods can affect device reliability.
  - The absolute maximum V<sub>DD</sub> of 4V is a transient stress rating and is not meant as a functional operating condition. It is not recommended to operate the device at the absolute maximum rated conditions for any period of time.

## Recommended Operating Conditions (@T<sub>A</sub> = +25°C, unless otherwise specified.)

Symbol	Parameter	Conditions	Rating	Unit
V <sub>DD</sub>	Supply Voltage	Operating	1.6V to 3.6V	V
T <sub>A</sub>	Operating Temperature Range	Operating	-40 to +85	°C

### Electrical Characteristics (Notes 8 & 9) (@T<sub>A</sub> = +25°C, V<sub>DD</sub> = 1.8V, unless otherwise specified.)

Symbol	Parameter	Conditions	Min	Typ	Max	Unit
<b>Supply Current</b>						
I <sub>DD_uP_MODE</sub>	Average Supply Current in Micropower Mode with Continuous Sampling Rate of 24Hz (CNTRL = GND Continuously)	V <sub>OUTPUT</sub> = V <sub>DD</sub> /2, CNTRL = GND, V <sub>DD</sub> = 1.8V (Note 10)	—	13	20	μA
		V <sub>OUTPUT</sub> = V <sub>DD</sub> /2, CNTRL = GND, V <sub>DD</sub> = 3.0V (Note 10)	—	17	25	μA
I <sub>DD_TURBO_MODE</sub>	Average Supply Current in Turbo Mode with Continuous Sampling Rate of 6.25Hz (CNTRL = V <sub>DD</sub> Continuously)	V <sub>OUTPUT</sub> = V <sub>DD</sub> /2, CNTRL = V <sub>DD</sub> , V <sub>DD</sub> = 1.8V (Note 10)	—	1.01	1.3	mA
		V <sub>OUTPUT</sub> = V <sub>DD</sub> /2, CNTRL = GND, V <sub>DD</sub> = 3.0V (Note 10)	—	1.44	1.8	mA
I <sub>DD_7kHz_EXTDRV</sub>	Average Supply Current at 7.14kHz Sampling Rate When CNTRL is Externally Driven	V <sub>OUTPUT</sub> = V <sub>DD</sub> /2, CNTRL Clocking at 7.14kHz, V <sub>DD</sub> = 1.8V (Note 10)	—	1.16	1.5	mA
		V <sub>OUTPUT</sub> = V <sub>DD</sub> /2, CNTRL Clocking at 7.14kHz, V <sub>DD</sub> = 3V (Note 10)	—	1.65	2.1	mA

- Notes:
8. When power is initially turned on, the operating V<sub>DD</sub> (1.6V to 3.6V) must be applied to guaranteed the output sampling. After the supply voltage reaches minimum operating voltage, the output state is valid after t<sub>ON\_INITIAL</sub>.
  9. Typical data is at T<sub>A</sub> = +25°C, V<sub>DD</sub> = 1.8V, unless otherwise stated.
  10. The parameters are not tested in production. They are guaranteed by design, characterization and process control.

**Electrical Characteristics** (continued) (@T<sub>A</sub> = +25°C, V<sub>DD</sub> = 1.8V, unless otherwise specified.)

**CNTRL Pin Timing, Conversion Rate and I<sub>DD</sub> Supply Current Relationship**

**AH8503 CNTRL Pin Driven Externally – External Drive Mode**

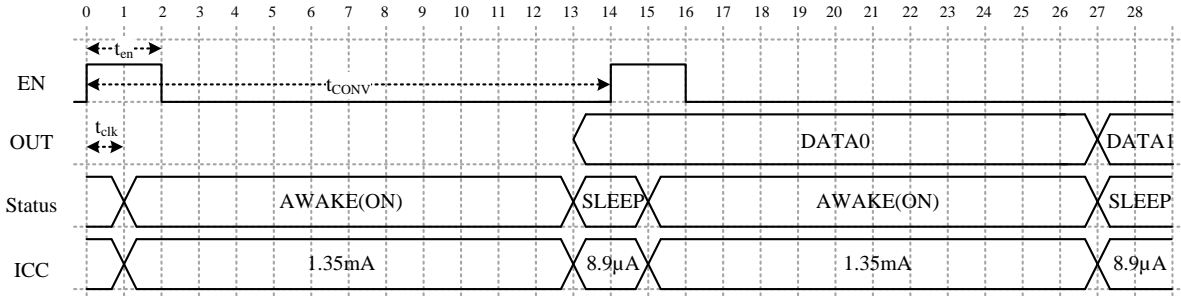

Status: **AWAKE**: chip processing phase (12\*t<sub>clk</sub>), **SLEEP**: chip retain data

t<sub>clk</sub>: internal clock period, typical = 10µs

t<sub>en</sub>: pulse width of enable signal, minimum=2\*t<sub>clk</sub>= 20µs (typical)

t<sub>conv</sub>: One sample/conversion cycle = 14\*t<sub>clk</sub>= 140µs (typical)

I<sub>DD</sub> (@ V<sub>DD</sub> = 1.8V, 25°C):

(1) If CNTRL pin clocked at maximum (~7.14 kHz): I<sub>DD</sub> = 1.35 mA\*12/14+8.93µA\*2/14 ≈ 1.16mA

(2) If CNTRL pin clocked at 24Hz: I<sub>DD</sub> ≈ 13µA

(3) If CNTRL clocking period =t, I<sub>DD</sub> = 1.35mA\*120µs/t + 8.93µA\*(t-120µs)/t

**AH8503 CNTRL = GND or Logic Low (0) Continuously – Micropower Mode**

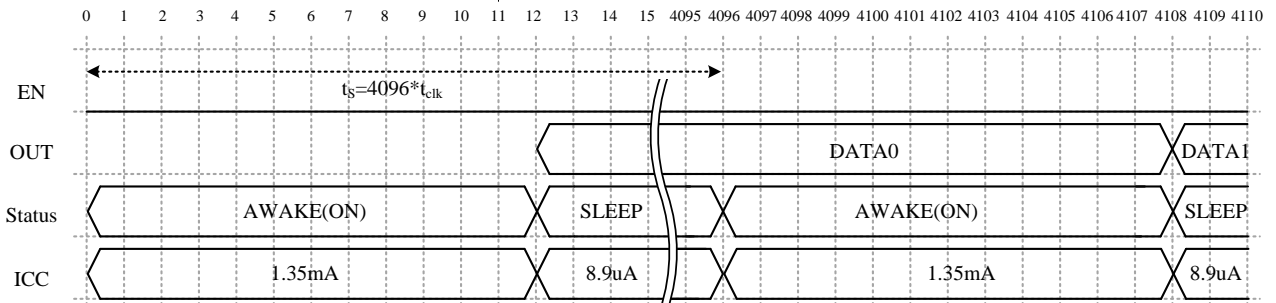

t<sub>clk</sub>: internal clock period, typical= 10µs

t<sub>s</sub>: awake cycle time = 4096\*t<sub>clk</sub> ≈ 41ms

**AH8503 CNTRL = V<sub>DD</sub> or Logic High Continuously – Turbo Mode**

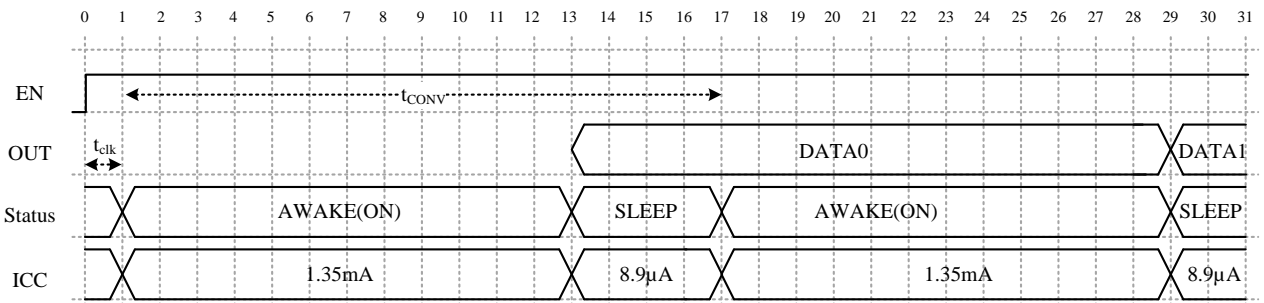

t<sub>clk</sub>: internal clock period, typical= 10µs

t<sub>conv</sub>: One sample/conversion period when ENABLE = High (V<sub>DD</sub>)= 16\*t<sub>clk</sub>=160µs

I<sub>DD</sub> (@ V<sub>DD</sub> = 1.8V, 25°C):

I<sub>DD</sub> = 1.35mA\*120µs/160µs + 8.93µA\*40µs/160µs ≈ 1.01mA (typical)

**Electrical Characteristics** (continued) (Notes 11, 12 & 13) (@ $T_A = +25^\circ\text{C}$ ,  $V_{DD} = 1.8\text{V}$ , unless otherwise specified.)

Symbol	Parameter	Conditions	Min	Typ	Max	Unit
t <sub>ON_INITIAL</sub>	Initial Power On Time	$V_{DD} = 1.8\text{V}$ , $T_A = +25^\circ\text{C}$ , $C_{IN} = 0.1\mu\text{F}$ $V_{DD}$ rise time = 10 $\mu\text{s}$ (Note 14)	—	1	—	ms
		$V_{DD} = 3\text{V}$ , $T_A = +25^\circ\text{C}$ , $C_{IN} = 0.1\mu\text{F}$ $V_{DD}$ rise time = 10 $\mu\text{s}$ (Note 14)	—	0.2	—	ms
t <sub>en</sub>	Minimum Pulse Width on CNTRL Pin to Start One Conversion Cycle When Driving CNTRL Pin Externally (See Application Note Section)	$V_{DD} = 1.6\text{V}$ to 3.6V, $T_A = -40^\circ\text{C}$ to +85 $^\circ\text{C}$ (Note 14)	—	20	—	$\mu\text{s}$
t <sub>CONV</sub>	Minimum Period of One Sample/Conversion Cycle	$V_{DD} = 1.6\text{V}$ to 3.6V, $T_A = -40^\circ\text{C}$ to +85 $^\circ\text{C}$ (Note 14)	100	140	200	$\mu\text{s}$
f <sub>MAX</sub>	Maximum Sampling Frequency	$V_{DD} = 1.6\text{V}$ to 3.6V, $T_A = -40^\circ\text{C}$ to +85 $^\circ\text{C}$ (Note 14)	—	7.14	—	kHz
f <sub>TURBO_MODE</sub>	Sampling Frequency in Turbo Mode with CNTRL = $V_{DD}$ or Logic High Continuously	CNTRL = High ( $V_{DD}$ ) $V_{DD} = 1.6\text{V}$ to 3.6V, $T_A = -40^\circ\text{C}$ to +85 $^\circ\text{C}$ (Note 14)	—	6.25	—	kHz
f <sub>uP_MODE</sub>	Sampling Frequency in Micropower Mode with CNTRL = GND or Logic Low Continuously	CNTRL = High ( $V_{DD}$ ) $V_{DD} = 1.6\text{V}$ to 3.6V, $T_A = -40^\circ\text{C}$ to +85 $^\circ\text{C}$ (Note 14)	—	24	—	Hz
t <sub>TURBO_MODE</sub>	Awake or Sampling Period in Turbo Mode with CNTRL = $V_{DD}$ or Logic High Continuously	CNTRL = High ( $V_{DD}$ ) $V_{DD} = 1.6\text{V}$ to 3.6V, $T_A = -40^\circ\text{C}$ to +85 $^\circ\text{C}$ (Note 14)	—	0.16	—	ms
t <sub>uP_MODE</sub>	Awake or Sampling Period in Micropower Mode with CNTRL = GND or Logic Low Continuously	CNTRL = High ( $V_{DD}$ ) $V_{DD} = 1.6\text{V}$ to 3.6V, $T_A = -40^\circ\text{C}$ to +85 $^\circ\text{C}$ (Note 14)	—	41.6	—	ms
V <sub>CNTRL_LOW</sub>	CNTRL Pin Input Low Voltage	$V_{DD} = 1.8\text{V}$ (Note 13)	0.4	0.5	0.6	V
		$V_{DD} = 3.0\text{V}$ (Note 13)	0.8	0.9	1	V
V <sub>CNTRL_HIGH</sub>	CNTRL Pin Input High Voltage	$V_{DD} = 1.8\text{V}$ (Note 13)	1.2	1.3	1.4	V
		$V_{DD} = 3\text{V}$ (Note 13)	2.2	2.3	2.4	V
<b>Output Characteristics</b>						
R <sub>OUT</sub>	DC Output Resistance	CNTRL = $V_{DD}$ or GND $V_{DD} = 1.6\text{V}$ to 3.6V, $T_A = -40^\circ\text{C}$ to +85 $^\circ\text{C}$ (Note 14)	—	10	13	k $\Omega$
Noise <sub>RMS</sub>	Input Referred Noise, RMS (Note 14)	$C_{IN} = \text{Open}$ , $V_{DD} = 1.8\text{V}$ , $T_A = +25^\circ\text{C}$	—	0.36	—	G
		$C_{IN} = \text{Open}$ , $V_{DD} = 3.0\text{V}$ , $T_A = +25^\circ\text{C}$	—	0.24	—	G
ADC <sub>RES</sub> DAC <sub>RES</sub>	Internal ADC and DAC Resolution	(Note 14)	—	8	—	Bit
V <sub>OUT_RES</sub>	Output Voltage Resolution	$V_{DD} = 1.6\text{V}$ to 3.6V, $T_A = -40^\circ\text{C}$ to +85 $^\circ\text{C}$	—	$V_{DD}/256$	—	mV
V <sub>OUTH</sub>	Max. Output Voltage	$V_{DD} = 1.6\text{V}$ to 3.6V, $T_A = -40^\circ\text{C}$ to +85 $^\circ\text{C}$	—	$V_{DD} * 255/256$	—	V
V <sub>OUTL</sub>	Min. Output Voltage	$V_{DD} = 1.6\text{V}$ to 3.6V, $T_A = -40^\circ\text{C}$ to +85 $^\circ\text{C}$	—	0	—	V

- Notes:
- When power is initially turned on, the operating  $V_{DD}$  (1.6V to 3.6V) must be applied to guarantee the output sampling. The output state is valid after t<sub>ON\_INITIAL</sub> from the supply voltage reaching the minimum operating voltage.
  - Typical data is at  $T_A = +25^\circ\text{C}$ ,  $V_{DD} = 1.8\text{V}$  unless otherwise stated.
  - Maximum and minimum parameters values over operating temperature range are not tested in production. They are guaranteed by design, characterization and process control.
  - The parameters are not tested in production. They are guaranteed by design, characterization and process control.

**Electrical Characteristics** (continued) (Notes 11, 12 & 13) (@ $T_A = +25^\circ\text{C}$ ,  $V_{DD} = 1.8\text{V}$ , unless otherwise specified.)

Symbol	Parameter	Conditions	Min	Typ	Max	Unit
<b>Magnetic Characteristics</b>						
BRANGE	Measurable Magnetic Flux Density Range	$V_{DD} = 1.8\text{V}$ , $T_A = +25^\circ\text{C}$	±388	±400	±412	G
		$V_{DD} = 3\text{V}$ , $T_A = +25^\circ\text{C}$	±382	±395	±408	G
GRES	Gauss Resolution	$V_{DD} = 1.8\text{V}$ , $T_A = +25^\circ\text{C}$	3.033	3.125	3.221	G/LSB
		$V_{DD} = 3\text{V}$ , $T_A = +25^\circ\text{C}$	2.994	3.084	3.179	G/LSB
VNULL	Quiescent Output Voltage with Zero Gauss	$B = 0.5\text{G}$ , $T_A = +25^\circ\text{C}$	—	$V_{DD} / 2$	—	V
		$V_{DD} = 1.8\text{V}$ , $T_A = +25^\circ\text{C}$	0.882	0.9	0.918	V
		$V_{DD} = 3\text{V}$ , $T_A = +25^\circ\text{C}$	1.47	1.5	1.53	V
VOFFSET	Quiescent Output Voltage Offset	$B = 0.5\text{G}$ , $V_{DD} = 1.8\text{V}$ , $T_A = +25^\circ\text{C}$	-1%	—	1%	% of $V_{DD}$
		$B = 0.5\text{G}$ , $V_{DD} = 3\text{V}$ , $T_A = +25^\circ\text{C}$	-1%	—	1%	% of $V_{DD}$
		$B = 0.5\text{G}$ , $V_{DD} = 1.6\text{V}$ to $3.6\text{V}$ $T_A = -40^\circ\text{C}$ to $+85^\circ\text{C}$ (Note 14)	-1.5	—	1.5	% of $V_{DD}$
VSENS	Output Voltage Sensitivity	$V_{DD} = 1.8\text{V}$ , $T_A = +25^\circ\text{C}$	2.183	2.25	2.318	mV/G
		$V_{DD} = 3\text{V}$ , $T_A = +25^\circ\text{C}$	3.686	3.80	3.914	
VSENS_ACC	Sensitivity Accuracy	$V_{DD} = 1.8\text{V}$ , $T_A = +25^\circ\text{C}$	-3	—	3	%
		$V_{DD} = 3\text{V}$ , $T_A = +25^\circ\text{C}$	-3	—	3	%
		$V_{DD} = \text{fixed at any one voltage between } 1.6\text{V to } 3.6\text{V}$ $T_A = -40^\circ\text{C}$ to $+85^\circ\text{C}$ (Notes 14 & 15)	-6	—	6	%
TC_ERRSENS	Sensitivity Error over Full Temperature	$V_{DD} = \text{fixed}$ , $T_A = -40^\circ\text{C}$ to $+85^\circ\text{C}$ (Note 14)	-3	—	3	%
Lin+	Positive Linearity (Span Linearity)	$V_{DD} = 1.8\text{V}$ , $T_A = +25^\circ\text{C}$ (Note 14)	—	99.9	—	%
		$V_{DD} = 3.0\text{V}$ , $T_A = +25^\circ\text{C}$ (Note 14)	—	99.7	—	%
Lin-	Negative Linearity (Span Linearity)	$V_{DD} = 1.8\text{V}$ , $T_A = +25^\circ\text{C}$ (Note 14)	—	100.1	—	%
		$V_{DD} = 3.0\text{V}$ , $T_A = +25^\circ\text{C}$ (Note 14)	—	100.4	—	%

- Notes:
- When power is initially turned on, the operating  $V_{DD}$  (1.6V to 3.6V) must be applied to guarantee the output sampling. The output state is valid after  $t_{ON\_INITIAL}$  from the supply voltage reaching the minimum operating voltage.
  - Typical data is at  $T_A = +25^\circ\text{C}$ ,  $V_{DD} = 1.8\text{V}$  unless otherwise stated.
  - Maximum and minimum parameters values over operating temperature range are not tested in production. They are guaranteed by design, characterization and process control.
  - The parameters are not tested in production. They are guaranteed by design, characterization and process control.
  - This term constitutes of output voltage sensitivity temperature coefficient error and sensitivity trim accuracy.

## Application Note

### CNTRL Pin - Awake and Sleep Period and Operating Mode Control

CNTRL pin controls the device operating mode (Micropower, Turbo, External-Drive modes) and “Awake” and “Sleep” periods during external-drive mode.

When the CNTRL pin is pulled low or GND continuously, the device operates in micropower mode with a sampling rate of 24Hz and consumes only 13µA typical at 1.8V. The CNTRL pin is internally pulled low and therefore the default mode is micropower mode if the CNTRL pin is left floating.

When CNTRL is pulled high (CNTRL = V<sub>DD</sub> or pulled high) continuously, the device runs in Turbo Mode with a sampling rate of 6.25kHz and consumes 1.01mA typical at 1.8V. When the CNTRL pin is pulled high continuously, the conversion time t<sub>CONV</sub> is 16 clock cycles (160µs typical) and therefore the sampling rate is 6.25kHz.

If the CNTRL pin is driven externally with a PWM signal (External-Drive Mode), the sampling rate can be adjusted from 24Hz to 7.14kHz. A minimum pulse width on CNTRL pin to start a sample/conversion is 20µs typical; we recommend using a pulse width of 40µs minimum.

In external-drive mode with a PWM signal on the CNTRL pin, the conversion time (signal acquisition, conversion and output update) t<sub>CONV</sub> is 14 clock cycles (140µs typical). When the CNTRL goes high, the sample trigger delay is 1 clock pulse (10µs) where the supply current remains at 8.93µA typical at V<sub>DD</sub> = 1.8V. After the sample trigger delay, the next 12 clock pulse (120µs typical) is the ‘Awake’ period, where the typical supply current is 1.35mA at 1.8V supply. The next pulse (10µs) is used to update the output stage and during this time the supply current drops back to 8.93µA typical at 1.8V supply. Therefore, the average supply current of the device depends on the sampling frequency and at the maximum sampling rate of 7.14kHz, it is 1.16mA typical at 1.8V.

The maximum sampling frequency is 7.14kHz when the CNTRL pin is externally driven with a PWM signal.

For CNTRL pin clocking period of t, the average current is given by

$$I_{DD} = \frac{1.35mA \times 120\mu s + 8.93\mu A \times (t - 120\mu s)}{t} \quad (@ 1.8V)$$

$$I_{DD} = \frac{I_{DD\_AWAKE} \times 120\mu s + I_{DD\_SLEEP} \times (t - 120\mu s)}{t} \quad (\text{General equation})$$

### Quiescent Output Voltage V<sub>NULL</sub> and Offset Voltage

The figure below shows the ideal transfer curve near zero magnetic field (B = 0 Gauss). Zero Gauss is the transition point between V<sub>OUTPUT</sub> = V<sub>DD</sub>\*127/128 and V<sub>OUTPUT</sub> = V<sub>DD</sub>/2. When B is slightly larger than zero, the output is one-half the supply voltage typically.

Quiescent output voltage (V<sub>NULL</sub>) is defined as the typical output voltage when B = 0.5 Gauss (slightly higher than 0G). Any difference of V<sub>NULL</sub> from V<sub>DD</sub>/2 introduces offset (V<sub>OFFSET</sub>).

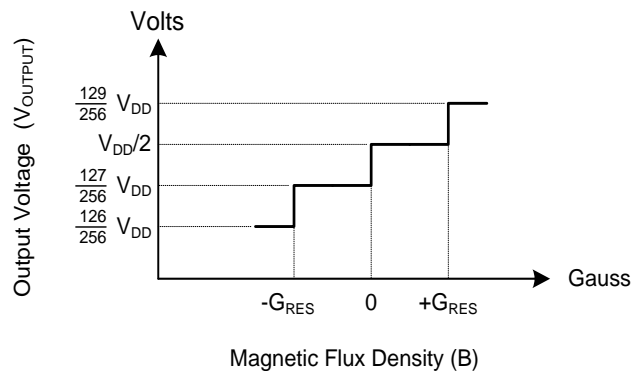

Transfer Curve Near 0 Gauss



**Application Note** (continued)

**Sensitivity and Transfer Characteristic**

The device responds to the magnetic flux density perpendicular to the part marking surface. For South pole magnetic flux density increase from 0G, the output voltage will increase from  $V_{NULL}$  and for a North magnetic pole field, the output will decrease from  $V_{NULL}$ . The changes in the voltage level up or down are symmetrical to  $V_{NULL}$  and are proportional to the magnetic flux density.

The output voltage change is proportional to the magnitude and polarity of the magnetic field perpendicular to the part marking surface. This proportionality is defined as output voltage sensitivity and is given by:

$$V_{SENS} = \frac{(V_{OUT(B\_MAX)} - V_{OUT(B\_MIN)})}{(B_{MAX} - B_{MIN})}$$

The AH8503 has a measurable magnetic field range of +/-400G and output voltage range of 0V to (255/256) $V_{DD}$ . Therefore, sensitivity at 1.8V is given by:

$$V_{SENS\_1.8V} = \frac{1.8V}{800G} = 2.25mV/G$$

The device has an internal ADC and DAC with resolution of 8-bits. Therefore the measurement resolution is 3.125G/LSB at  $V_{DD} = 1.8V$ . In terms of voltage, the output resolution at 1.8V is 7mV/LSB typical. The device follows the 8-bit step for transfer curve superimposed on the  $V_{SENS}$  above. This difference in theoretical linear value with 8-bit resolution steps produces a measurement (quantization) error at each step.

Quantization error (also measurement error) = 0.5\*step =  $V_{DD}/512$  (output voltage)  
Or = Full magnetic range/512 (input magnetic field)

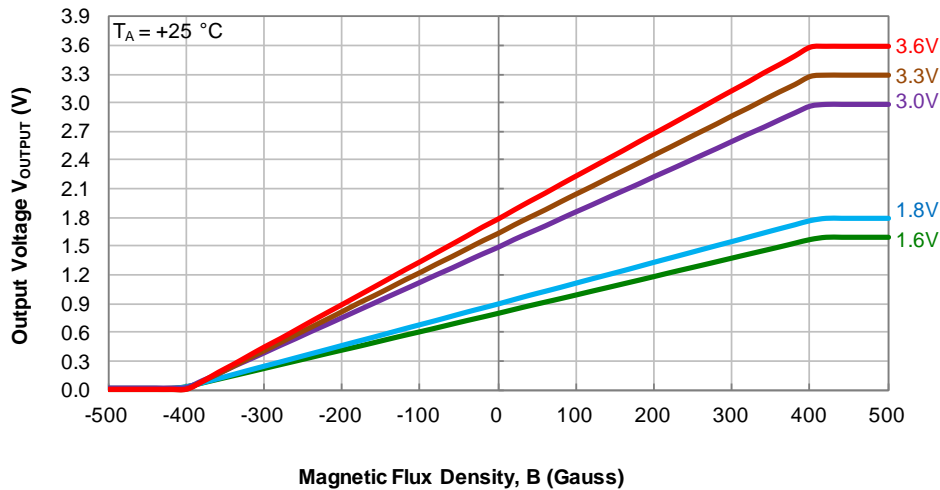

**Transfer Curve – Output Voltage vs. Magnetic Flux Density**

**Application Note** (continued)

**Span Linearity**

Coordinate of transition points (V0 to V255 and B0 to B254) can be extracted from a transfer curve. Span linearity is defined and based on these coordinate points.

Span linearity is defined as linearity arising from sensitivity differences between the maximum flux density range and half of the range for positive and negative flux density. Referring to the diagram below, north field span linearity LIN- and south field span linearity LIN+ are given by:

$$LIN- = \frac{(V0 - V127)/(B0 - B127)}{(V64 - V127)/(B64 - B127)}$$

$$LIN+ = \frac{(V254 - V127)/(B254 - B127)}{(V190 - V127)/(B190 - B127)}$$

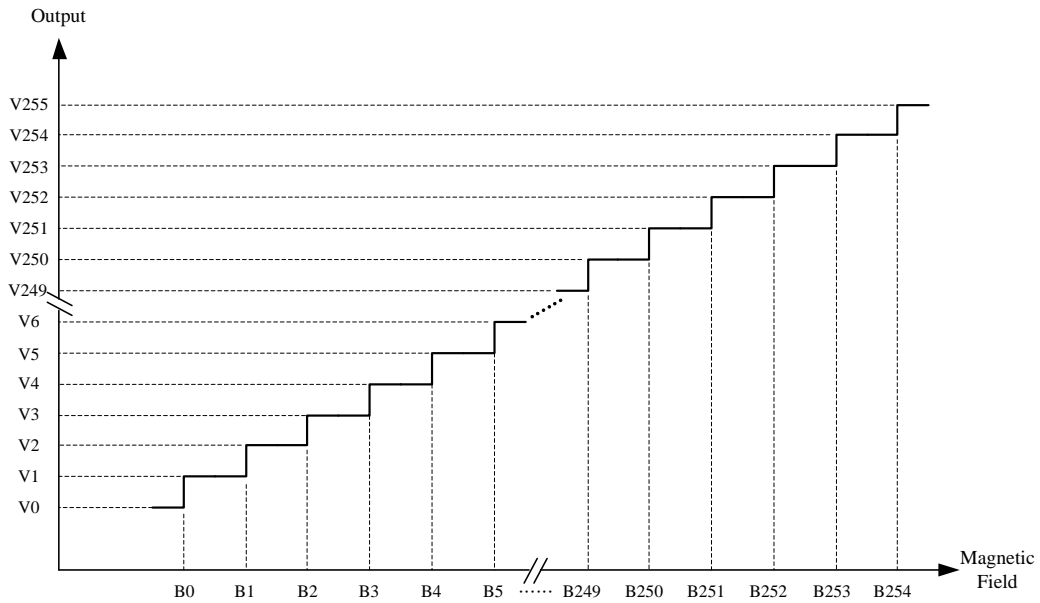

## Typical Operating Characteristics

### Average Supply Current

Micropower Mode – 24Hz Sample Rate

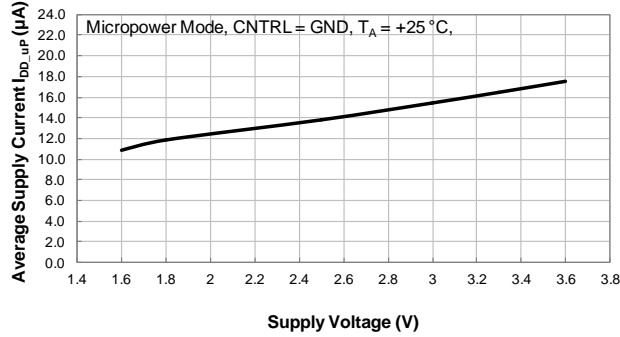

Micropower Mode – 24Hz Sample Rate

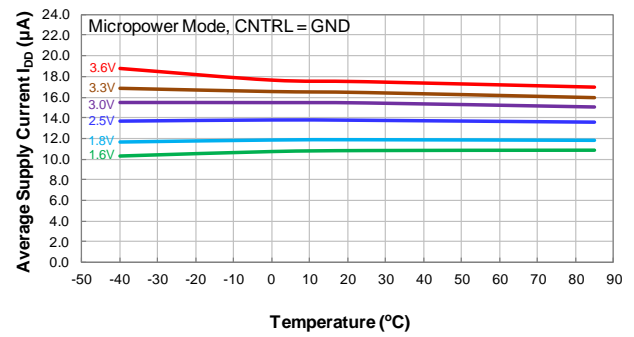

Turbo Mode – 6.25kHz Sample Rate

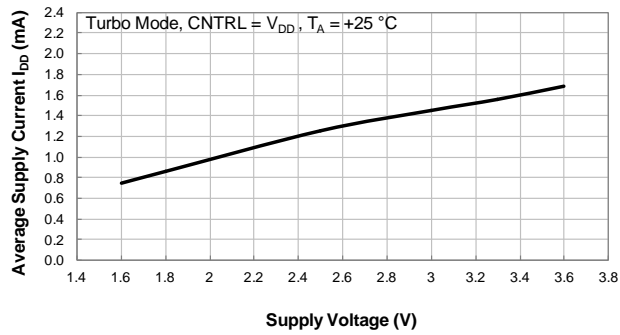

Turbo Mode – 6.25kHz Sample Rate

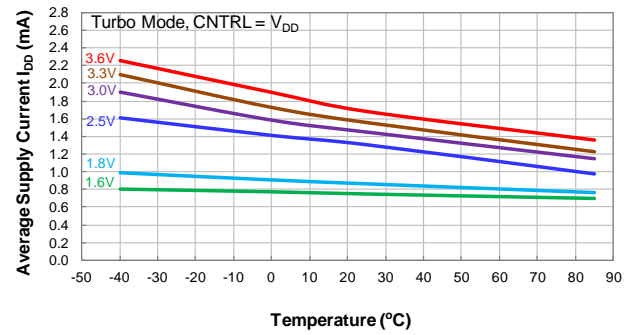

External Drive Mode with 7.14kHz Sampling Rate

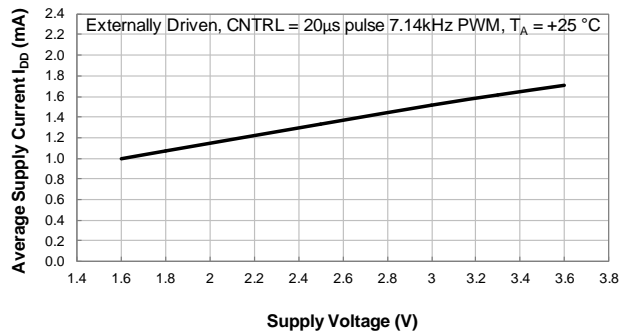

External-Drive Mode with 7.14kHz Sampling Rate

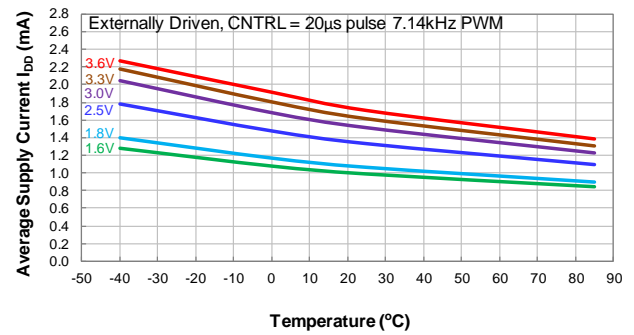

**Typical Operating Characteristics** (continued)

**Typical Initial Power On Time**

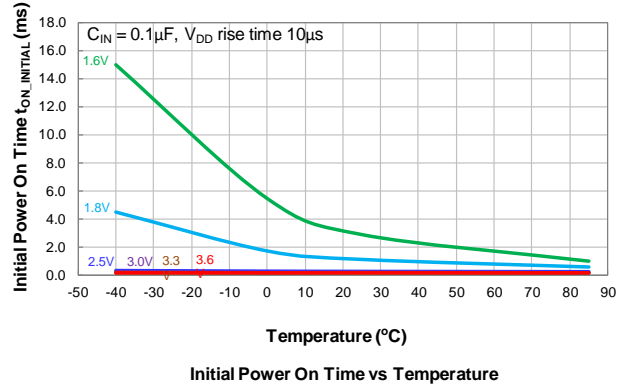
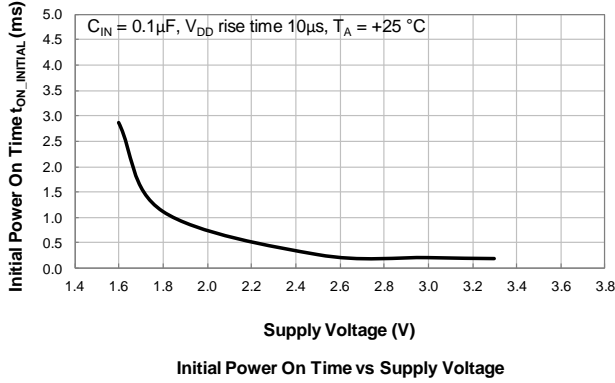

**Typical Sensitivity**

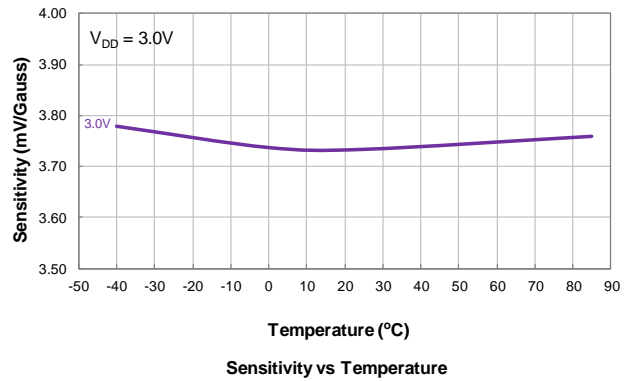
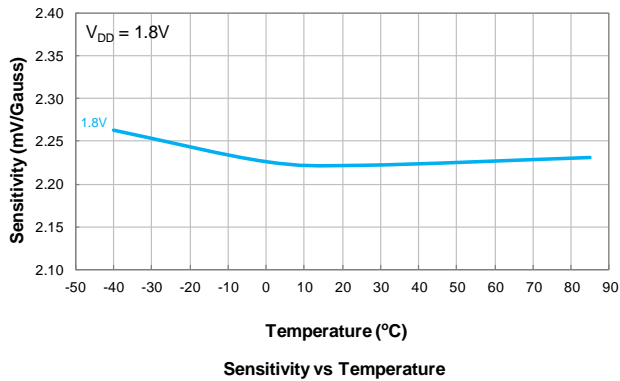
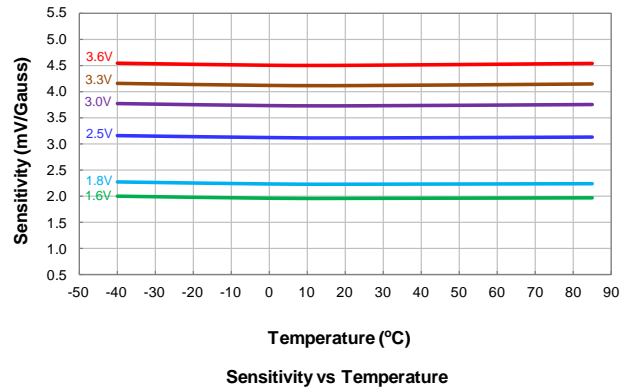
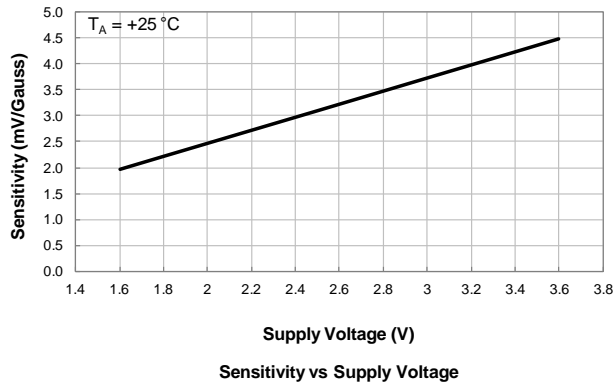

**Typical Operating Characteristics** (continued)

**Typical Transfer Curves**

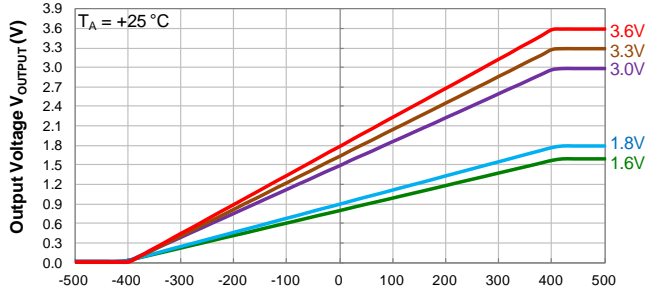

Magnetic Flux Density, B (Gauss)  
Output Voltage vs Magnetic Flux Density

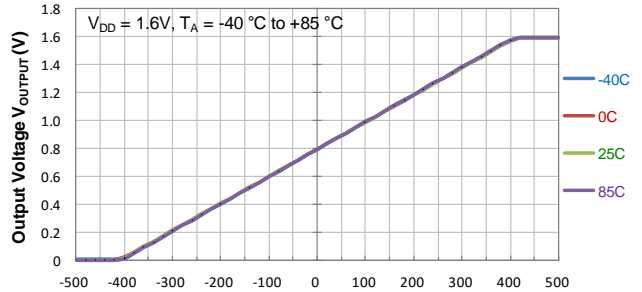

Magnetic Flux Density, B (Gauss)  
Output Voltage vs Magnetic Flux Density

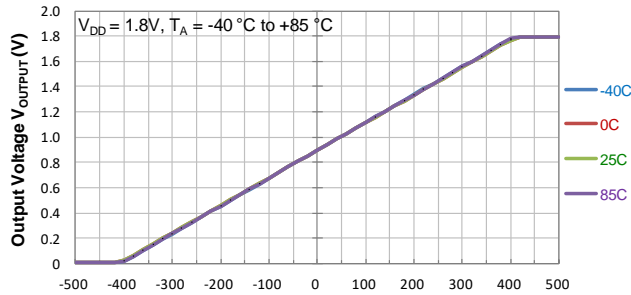

Magnetic Flux Density, B (Gauss)  
Output Voltage vs Magnetic Flux Density

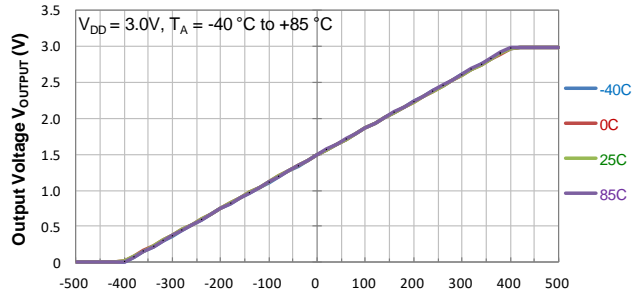

Magnetic Flux Density, B (Gauss)  
Output Voltage vs Magnetic Flux Density

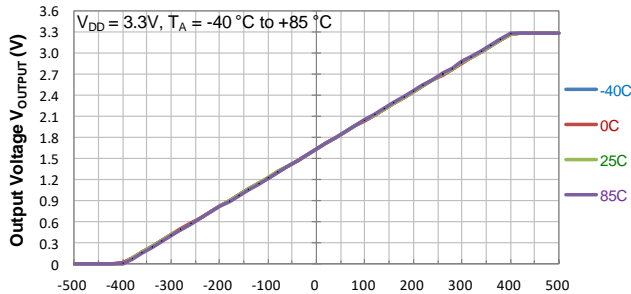

Magnetic Flux Density, B (Gauss)  
Output Voltage vs Magnetic Flux Density

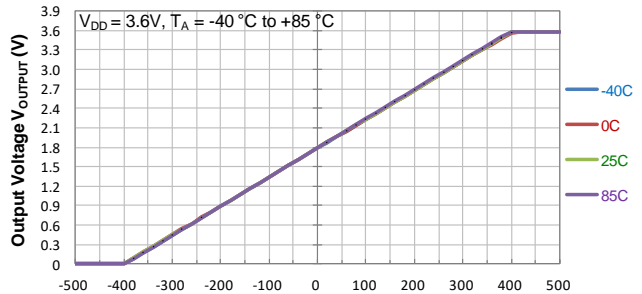

Magnetic Flux Density, B (Gauss)  
Output Voltage vs Magnetic Flux Density

**Typical Operating Characteristics** (continued)

**Typical Null Voltage: Output Voltage at B = 0+ Gauss** (Note 16)

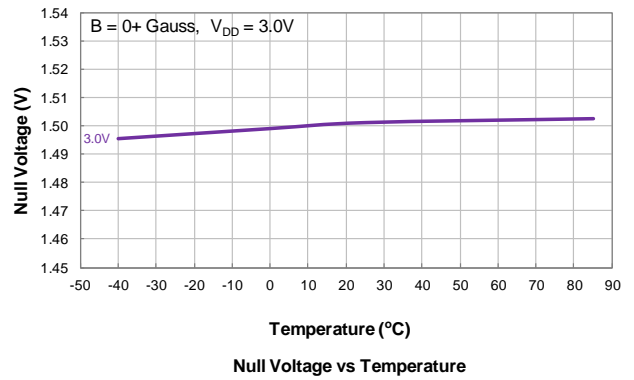
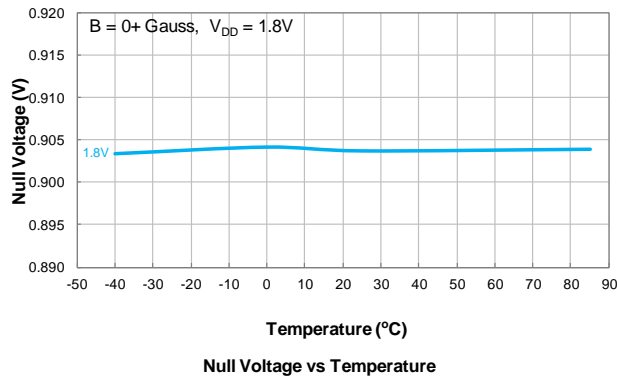
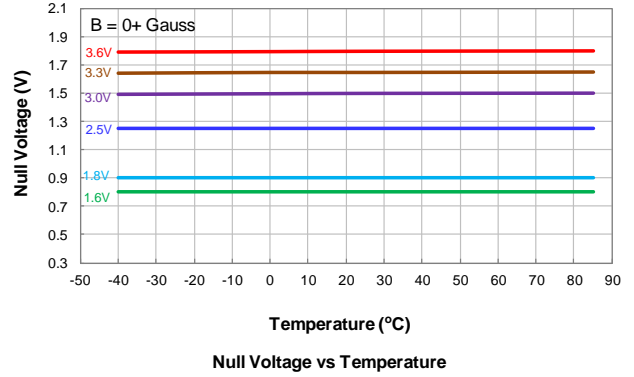
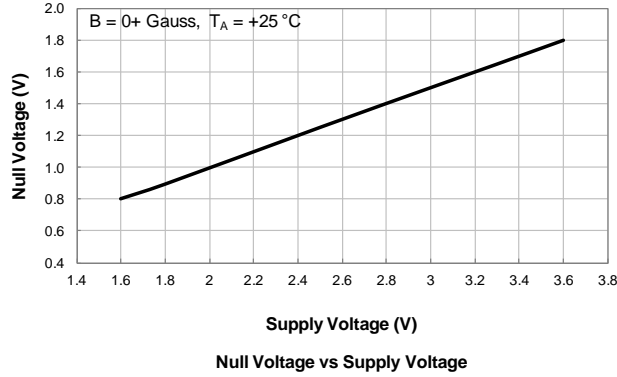

Note: 16. Null voltage is the voltage with magnetic flux density B = 0G at the sensor. B = 0G is also the transition point at  $V_{DD} * 127/128$  for internal ADC and DAC. To avoid the transition point fluctuation during measurement of null voltage, B = 0+ Gauss (e.g. 0.5G which is smaller than 1LSB gauss step of 3.125G) is used. See definition of the null voltage in *Application Note* section.

**Typical Operating Characteristics** (continued)

**Typical Null Voltage Offset: (Output Voltage -  $V_{DD}/2$ ) at  $B = 0+$  Gauss** (Note 16)

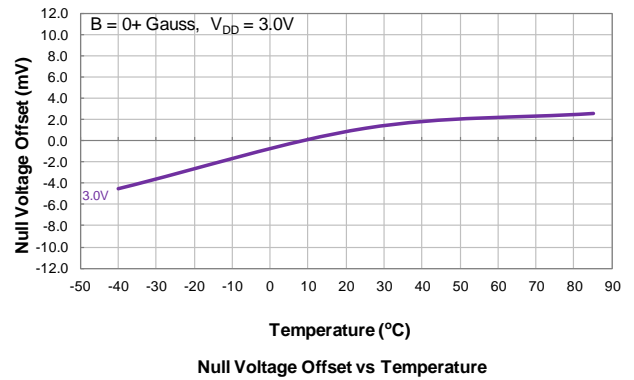
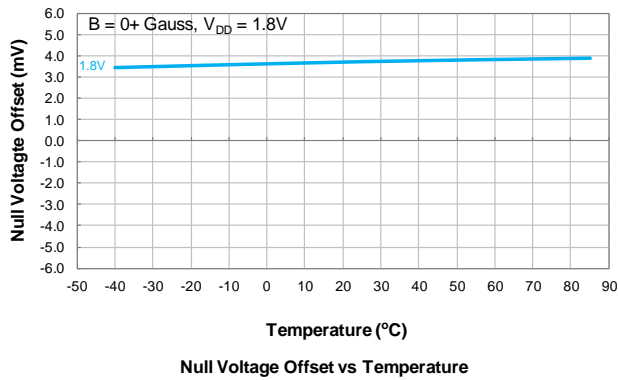
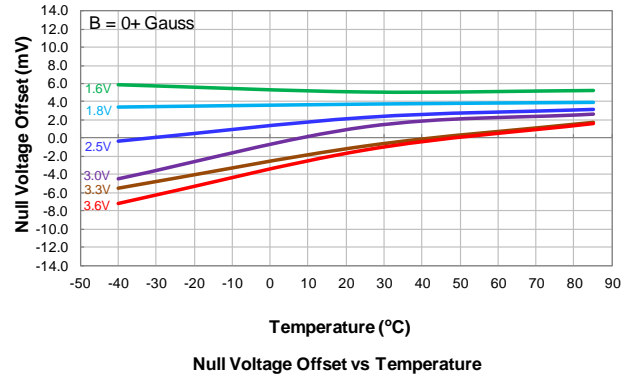
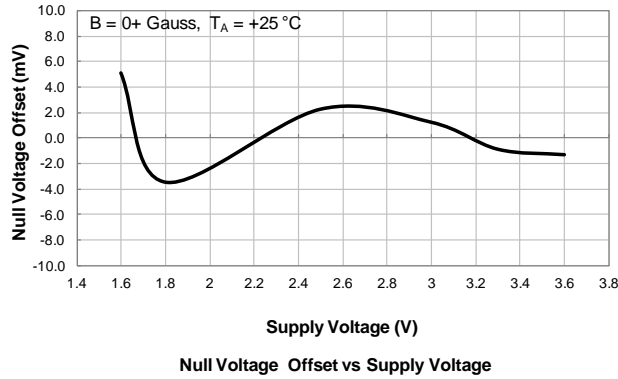

Note: 16. Null voltage is the voltage with magnetic flux density  $B = 0G$  at the sensor.  $B = 0G$  is also the transition point at  $V_{DD} \cdot 127/128$  for internal ADC and DAC. To avoid the transition point fluctuation during measurement of null voltage,  $B = 0+$  Gauss (e.g. 0.5G which is smaller than 1LSB gauss step of 3.125G) is used. See definition of the null voltage in *Application Note* section.

## Ordering Information

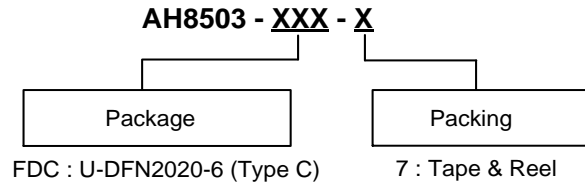

Part Number	Part Number Suffix	Package Code	Package	Packing	
				Qty.	Carrier
AH8503-FDC-7	-7	FDC	U-DFN2020-6 (Type C)	3,000	7" Tape & Reel

## Marking Information

Package Type: U-DFN2020-6 (Type C)

( Top View )

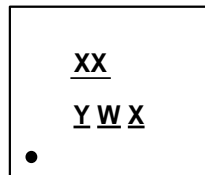

XX : Identification Code  
Y : Year : 0 to 9 (ex: 3 = 2023)  
W : Week : A to Z : week 1 to 26;  
 a to z : week 27 to 52; z represents  
 week 52 and 53  
X : Internal Code

Part Number	Package	Identification Code
AH8503-FDC-7	U-DFN2020-6 (Type C)	KY



**Package Outline Dimensions**

Please see <http://www.diodes.com/package-outlines.html> for the latest version.

**U-DFN2020-6 (Type C)**

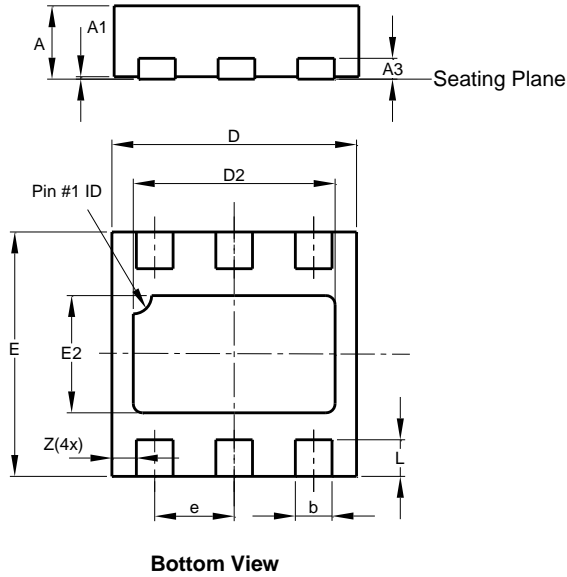

U-DFN2020-6 (Type C)			
Dim	Min	Max	Typ
A	0.57	0.63	0.60
A1	0.00	0.05	0.02
A3	—	—	0.15
b	0.25	0.35	0.30
D	1.95	2.075	2.00
D2	1.55	1.75	1.65
E	1.95	2.075	2.00
E2	0.86	1.06	0.96
e	—	—	0.65
L	0.25	0.35	0.30
Z	—	—	0.20
All Dimensions in mm			

**Bottom View**

**Top view**

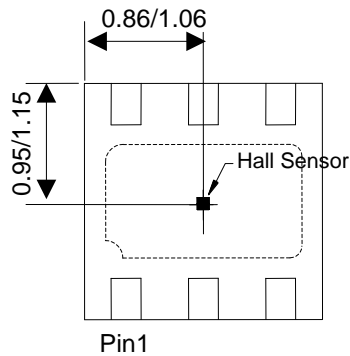

**Min/Max (in mm)**

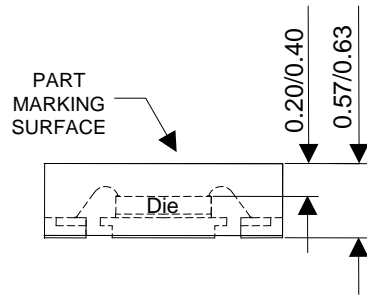

**Sensor Location**

## Suggested Pad Layout

Please see <http://www.diodes.com/package-outlines.html> for the latest version.

U-DFN2020-6 (Type C)

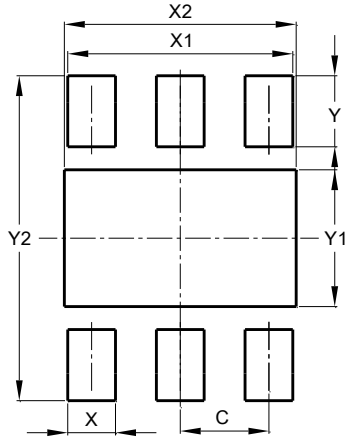

Dimensions	Value (in mm)
C	0.650
X	0.350
X1	1.650
X2	1.700
Y	0.525
Y1	1.010
Y2	2.400

## Mechanical Data

- Moisture Sensitivity: Level 1 per J-STD-020
- Terminals: Finish - NiPdAu over Copper Leads, Solderable per MIL-STD-202, Method 208 (4)
- Weight: 0.008 grams (Approximate)

**IMPORTANT NOTICE**

1. DIODES INCORPORATED (Diodes) AND ITS SUBSIDIARIES MAKE NO WARRANTY OF ANY KIND, EXPRESS OR IMPLIED, WITH REGARDS TO ANY INFORMATION CONTAINED IN THIS DOCUMENT, INCLUDING, BUT NOT LIMITED TO, THE IMPLIED WARRANTIES OF MERCHANTABILITY, FITNESS FOR A PARTICULAR PURPOSE OR NON-INFRINGEMENT OF THIRD PARTY INTELLECTUAL PROPERTY RIGHTS (AND THEIR EQUIVALENTS UNDER THE LAWS OF ANY JURISDICTION).
2. The Information contained herein is for informational purpose only and is provided only to illustrate the operation of Diodes' products described herein and application examples. Diodes does not assume any liability arising out of the application or use of this document or any product described herein. This document is intended for skilled and technically trained engineering customers and users who design with Diodes' products. Diodes' products may be used to facilitate safety-related applications; however, in all instances customers and users are responsible for (a) selecting the appropriate Diodes products for their applications, (b) evaluating the suitability of Diodes' products for their intended applications, (c) ensuring their applications, which incorporate Diodes' products, comply the applicable legal and regulatory requirements as well as safety and functional-safety related standards, and (d) ensuring they design with appropriate safeguards (including testing, validation, quality control techniques, redundancy, malfunction prevention, and appropriate treatment for aging degradation) to minimize the risks associated with their applications.
3. Diodes assumes no liability for any application-related information, support, assistance or feedback that may be provided by Diodes from time to time. Any customer or user of this document or products described herein will assume all risks and liabilities associated with such use, and will hold Diodes and all companies whose products are represented herein or on Diodes' websites, harmless against all damages and liabilities.
4. Products described herein may be covered by one or more United States, international or foreign patents and pending patent applications. Product names and markings noted herein may also be covered by one or more United States, international or foreign trademarks and trademark applications. Diodes does not convey any license under any of its intellectual property rights or the rights of any third parties (including third parties whose products and services may be described in this document or on Diodes' website) under this document.
5. Diodes' products are provided subject to Diodes' Standard Terms and Conditions of Sale (<https://www.diodes.com/about/company/terms-and-conditions/terms-and-conditions-of-sales/>) or other applicable terms. This document does not alter or expand the applicable warranties provided by Diodes. Diodes does not warrant or accept any liability whatsoever in respect of any products purchased through unauthorized sales channel.
6. Diodes' products and technology may not be used for or incorporated into any products or systems whose manufacture, use or sale is prohibited under any applicable laws and regulations. Should customers or users use Diodes' products in contravention of any applicable laws or regulations, or for any unintended or unauthorized application, customers and users will (a) be solely responsible for any damages, losses or penalties arising in connection therewith or as a result thereof, and (b) indemnify and hold Diodes and its representatives and agents harmless against any and all claims, damages, expenses, and attorney fees arising out of, directly or indirectly, any claim relating to any noncompliance with the applicable laws and regulations, as well as any unintended or unauthorized application.
7. While efforts have been made to ensure the information contained in this document is accurate, complete and current, it may contain technical inaccuracies, omissions and typographical errors. Diodes does not warrant that information contained in this document is error-free and Diodes is under no obligation to update or otherwise correct this information. Notwithstanding the foregoing, Diodes reserves the right to make modifications, enhancements, improvements, corrections or other changes without further notice to this document and any product described herein. This document is written in English but may be translated into multiple languages for reference. Only the English version of this document is the final and determinative format released by Diodes.
8. Any unauthorized copying, modification, distribution, transmission, display or other use of this document (or any portion hereof) is prohibited. Diodes assumes no responsibility for any losses incurred by the customers or users or any third parties arising from any such unauthorized use.
9. This Notice may be periodically updated with the most recent version available at <https://www.diodes.com/about/company/terms-and-conditions/important-notice>

The Diodes logo is a registered trademark of Diodes Incorporated in the United States and other countries.  
All other trademarks are the property of their respective owners.  
© 2023 Diodes Incorporated. All Rights Reserved.

[www.diodes.com](http://www.diodes.com)