

ULTRA LOW-VOLTAGE HIGH-SENSITIVITY MICROPOWER OMNIPOLAR HALL-EFFECT SWITCH

Description

The AH1899A is a high-sensitivity micropower, Omnipolar Hall-effect switch IC with internal pullup and pulldown capability. Designed for portable and battery-powered equipment, such as cellular phones and portable PCs, the average supply current is only 0.95 μ A at 1.2V and 1.1 μ A at 1.8V. To support portable equipment, the AH1899A can operate over the supply range of 1.1V to 2.0V and uses a hibernating clocking system to minimize the power consumption. To minimize PCB space, the AH1899A is available in a small low-profile X2-DFN1010-4 (Type B) package.

The output is activated with either a north or south pole of sufficient magnetic field strength. When the magnetic flux density (B) perpendicular to the package is larger than the operate point (B_{OP}), the output is turned on (pulled low). The output is turned off when B becomes lower than the release point (B_{RP}). The output will remain off when there is no magnetic field.

Features

- Omnipolar Operation (North or South Pole)
- Supply Voltage of 1.1V to 2.0V
- Micropower Operation
- Chopper Stabilized Design Provides:
 - Superior Temperature Stability
 - Minimal Switch Point Drift
 - Enhanced Immunity to Physical Stress
- No External Pullup Resistors Required
- Good RF Noise Immunity
- -40°C to +85°C Operating Temperature
- Small Low-Profile X2-DFN1010-4 (Type B) Package
- **Totally Lead-Free & Fully RoHS Compliant (Notes 1 & 2)**
- **Halogen and Antimony Free. "Green" Device (Note 3)**
- **For automotive applications requiring specific change control (i.e. parts qualified to AEC-Q100/101/104/200, PPAP capable, and manufactured in IATF 16949 certified facilities), please [contact us](mailto:contact@diodes.com) or your local Diodes representative. <https://www.diodes.com/quality/product-definitions/>**

- Notes:
1. No purposely added lead. Fully EU Directive 2002/95/EC (RoHS), 2011/65/EU (RoHS 2) & 2015/863/EU (RoHS 3) compliant.
 2. See <https://www.diodes.com/quality/lead-free/> for more information about Diodes Incorporated's definitions of Halogen- and Antimony-free, "Green" and Lead-free.
 3. Halogen- and Antimony-free "Green" products are defined as those which contain <900ppm bromine, <900ppm chlorine (<1500ppm total Br + Cl) and <1000ppm antimony compounds.

Pin Assignments

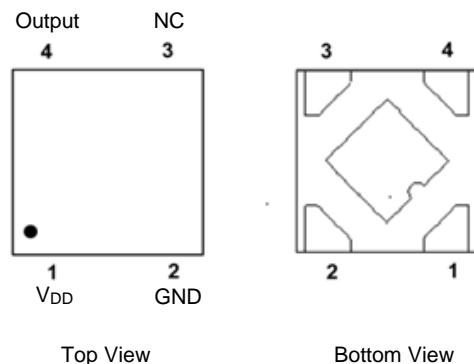

X2-DFN1010-4 (Type B)

Applications

- Cover or display switches in portable PCs
- Open and close detection for cellular phones
- Holster or cover detection for cellular phones and tablet PCs
- Digital still, video cameras, and handheld gaming consoles
- Contactless switches

Typical Applications Circuit

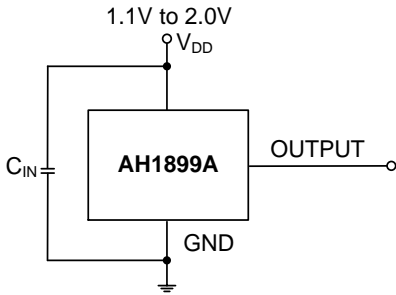

Note: 4. C_{IN} is for power stabilization and to strengthen the noise immunity. The recommended capacitance is 10nF to 100nF.

Pin Descriptions

Package: X2-DFN1010-4 (Type B)

Pin Number	Pin Name	Function
1	V_{DD}	Power Supply Input
2	GND	Ground Pin
3	NC	No Connection (Note 5)
4	OUTPUT	Output Pin

Note: 5. NC is the *No Connection* pin and is not connected internally. This pin can be left open or tied to ground.

Functional Block Diagram

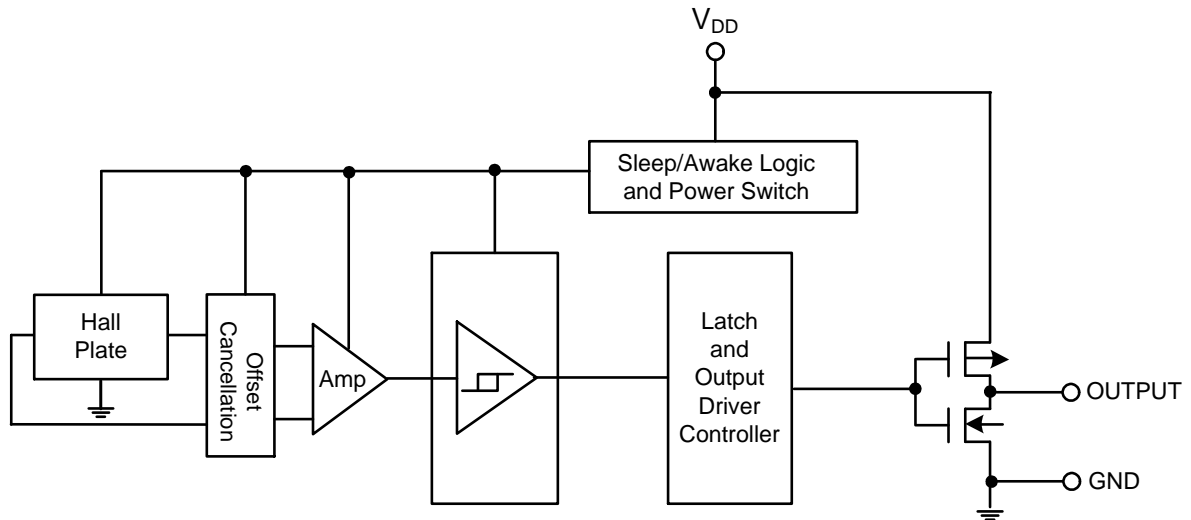

Absolute Maximum Ratings (Note 6) (@T_A = +25°C, unless otherwise specified.)

Symbol	Parameter	Rating	Unit
V _{DD}	Supply Voltage (Note 7)	2.2	V
V _{DD_REV}	Reverse Supply Voltage	-0.3	V
I _{OUTPUT}	Output Current (Source and Sink)	3	mA
B	Magnetic Flux Density	Unlimited	
P _D	Package Power Dissipation	X2-DFN1010-4 (Type B)	230 mW
T _S	Storage Temperature Range	-65 to +150	°C
T _J	Maximum Junction Temperature	+150	°C
ESD HBM	Human Body Model (HBM) ESD Capability	8	kV

- Notes:
- 6. Stresses greater than those listed under *Absolute Maximum Ratings* can cause permanent damage to the device. These are stress ratings only, and functional operation of the device at these or any other conditions beyond those indicated under *Recommended Operating Conditions* is not implied. Exposure to *Absolute Maximum Ratings* for extended periods can affect device reliability.
 - 7. The absolute maximum V_{DD} of 2.2V is a transient stress rating and is not meant as a functional operating condition. It is not recommended to operate the device at the absolute maximum rated conditions for any period of time.

Recommended Operating Conditions (@T_A = +25°C, unless otherwise specified.)

Symbol	Parameter	Conditions	Rating	Unit
V _{DD}	Supply Voltage	Operating	1.1 to 2	V
T _A	Operating Temperature Range	Operating	-40 to +85	°C

Electrical Characteristics (@T_A = +25°C, unless otherwise specified.)

Symbol	Parameter	Conditions	Min	Typ	Max	Unit
V _{OL}	Output Low Voltage (On)	I _{OUT} = 0.5mA, V _{DD} = 1.2V	—	0.1	0.2	V
V _{OH}	Output High Voltage (Off)	I _{OUT} = 0.5mA, V _{DD} = 1.2V	V _{DD} -0.2	V _{DD} -0.1	—	V
I _{DD} (awake)	Supply Current	During <i>Awake</i> Period, V _{DD} = 1.2V	—	0.55	1.1	mA
		During <i>Awake</i> Period, V _{DD} = 1.8V	—	0.68	1.4	mA
I _{DD} (sleep)	Supply Current	During <i>Sleep</i> Period, V _{DD} = 1.2V	—	0.29	0.6	µA
		During <i>Sleep</i> Period, V _{DD} = 1.8V	—	0.35	0.7	µA
I _{DD} (avg)	Average Supply Current	T _A = +25°C, V _{DD} = 1.2V	—	0.95	1.8	µA
		T _A = +25°C, V _{DD} = 1.8V	—	1.1	2.2	µA
t _{awake}	Awake Time	T _A = +25°C, V _{DD} = 1.2V (Note 8)	—	45	90	µs
t _{period}	Period	T _A = +25°C, V _{DD} = 1.2V (Note 8)	—	45	90	ms
D.C.	Duty Cycle	—	—	0.1	—	%

- Note:
- 8. When power is initially turned on, the operating V_{DD} (1.1V to 2.0V) must be applied to guarantee the output sampling. The output state is valid after the second operating cycle (typical 90ms).

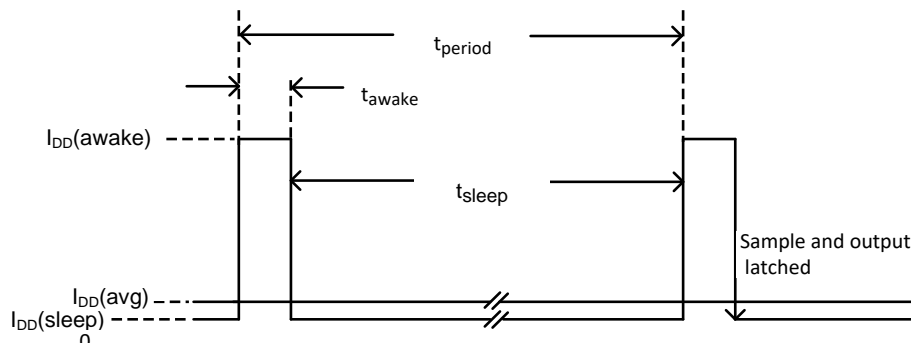

Magnetic Characteristics ($T_A = +25^\circ\text{C}$, $V_{DD} = 1.2\text{V}$, unless otherwise specified)

(1mT = 10 Gauss)

Symbol	Characteristics	Min	Typ	Max	Unit
B_{OPS} (South Pole to Part Marking Side)	Operation Point	6	18	30	Gauss
B_{OPN} (North Pole to Part Marking Side)		-30	-18	-6	
B_{RPS} (South Pole to Part Marking Side)	Release Point	2	12	24	
B_{RPN} (North Pole to Part Marking Side)		-24	-12	-2	
B_{HY} ($ B_{OPX} - B_{RPX} $)	Hysteresis	—	6	—	

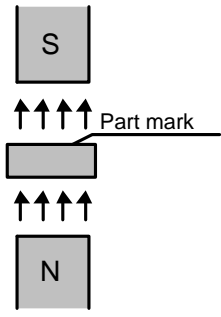
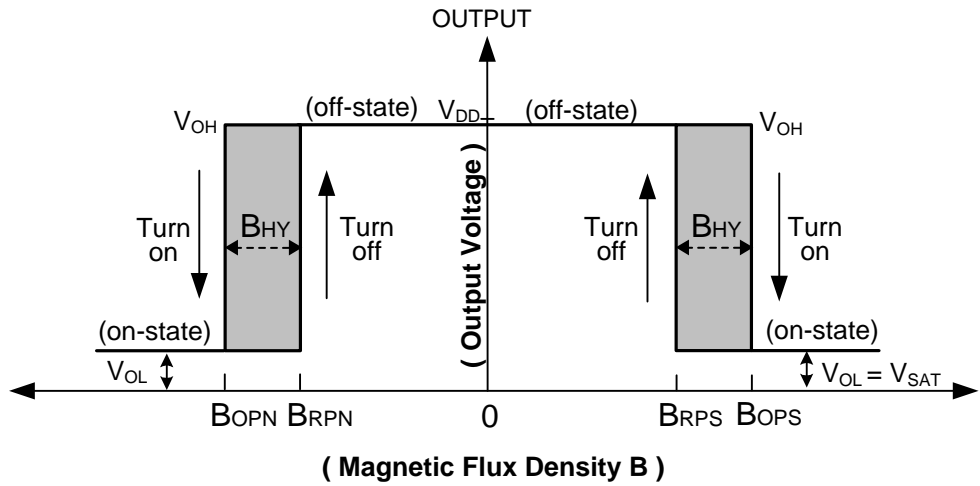

X2-DFN1010-4 (Type B)

Typical Operating Characteristics

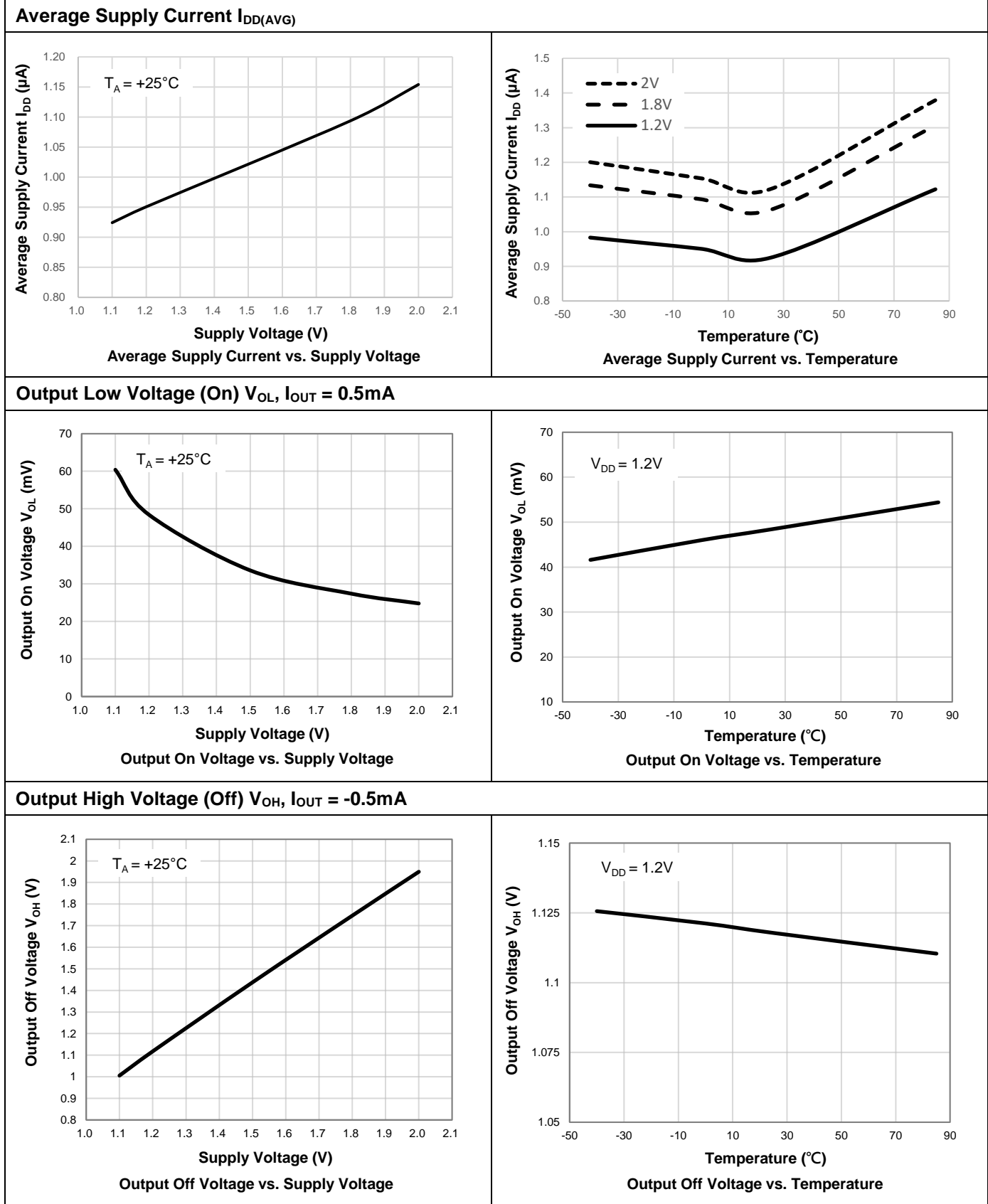

Typical Operating Characteristics (continued)

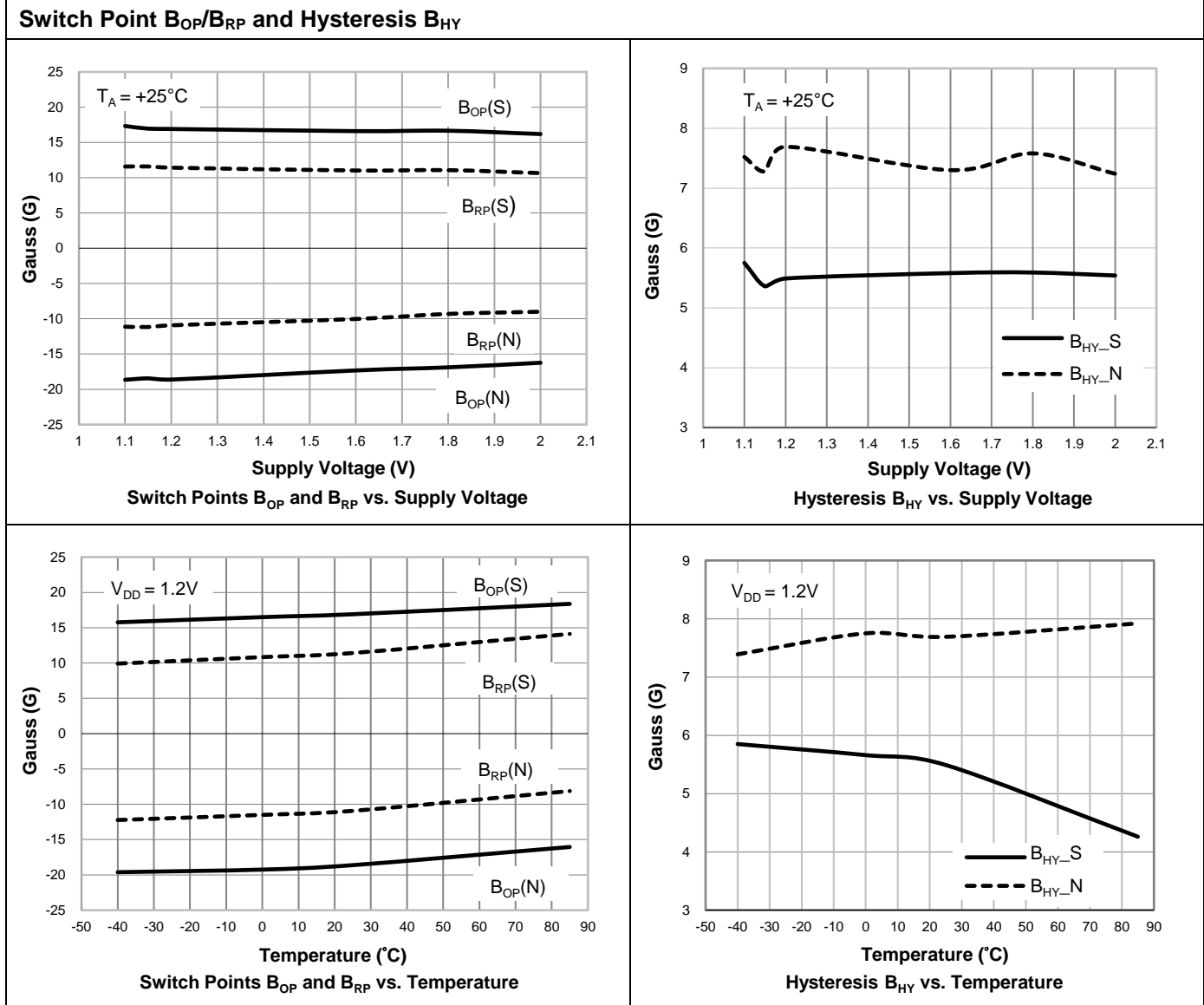

Ordering Information

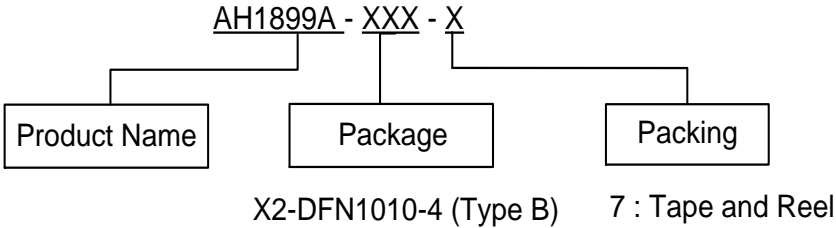

Part Number	Part Number Suffix	Package Code	Package	Packing	
				Qty.	Carrier
AH1899A-FS4-7	-7	FS4	X2-DFN1010-4 (Type B)	5000	7" Tape and Reel

Marking Information

Package Type: X2-DFN1010-4 (Type B)

(Top View)

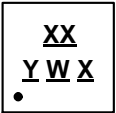

- XX : Identification Code
- Y : Year : 0 to 9 (ex: 3 = 2023)
- W : Week : A to Z : week 1 to 26;
a to z : week 27 to 52; z represents week 52 and 53
- X : Internal Code

Part Number	Package	Identification Code
AH1899A-FS4-7	X2-DFN1010-4 (Type B)	CX

Package Outline Dimensions (All dimensions in mm.)

Please see <http://www.diodes.com/package-outlines.html> for the latest version.

X2-DFN1010-4 (Type B)

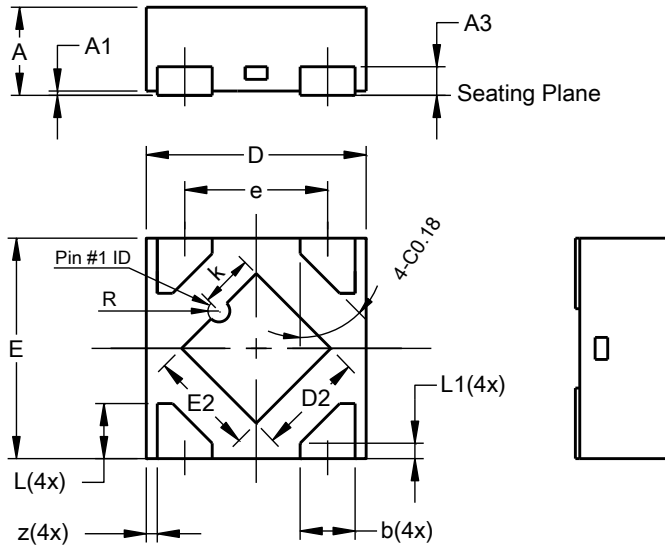

X2-DFN1010-4 (Type B)			
Dim	Min	Max	Typ
A	-	0.40	0.39
A1	0.00	0.05	0.02
A3	-	-	0.13
b	0.20	0.30	0.25
D	0.95	1.05	1.00
D2	0.43	0.53	0.48
E	0.95	1.05	1.00
E2	0.43	0.53	0.48
e	-	-	0.65
k	0.19	0.29	0.24
L	0.20	0.30	0.25
L1	0.02	0.12	0.07
R	0.02	0.08	0.05
z	-	-	0.050
All Dimensions in mm			

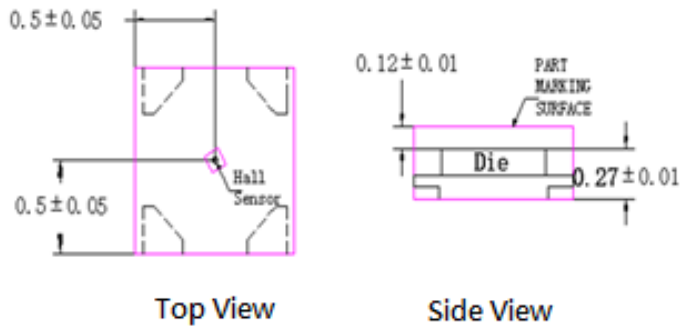

Sensor Location

Suggested Pad Layout

Please see <http://www.diodes.com/package-outlines.html> for the latest version.

X2-DFN1010-4 (Type B)

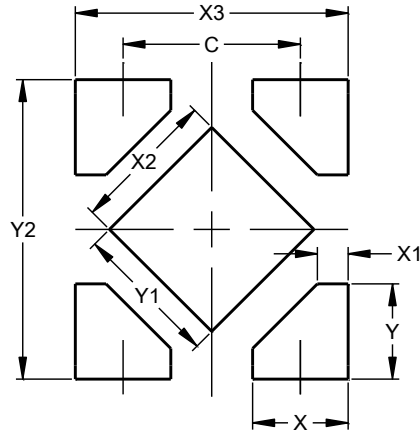

Dimensions	Value (in mm)
C	0.650
X	0.350
X1	0.112
X2	0.530
X3	1.00
Y	0.350
Y1	0.530
Y2	1.100

Mechanical Data

- Moisture Sensitivity: Level 1 per J-STD-020
- Terminals: Finish – NiPdAu over Copper Leads, Solderable per MIL-STD-202, Method 208 (e4)
- Weight: 0.001 grams (Approximate)

IMPORTANT NOTICE

1. DIODES INCORPORATED (Diodes) AND ITS SUBSIDIARIES MAKE NO WARRANTY OF ANY KIND, EXPRESS OR IMPLIED, WITH REGARDS TO ANY INFORMATION CONTAINED IN THIS DOCUMENT, INCLUDING, BUT NOT LIMITED TO, THE IMPLIED WARRANTIES OF MERCHANTABILITY, FITNESS FOR A PARTICULAR PURPOSE OR NON-INFRINGEMENT OF THIRD PARTY INTELLECTUAL PROPERTY RIGHTS (AND THEIR EQUIVALENTS UNDER THE LAWS OF ANY JURISDICTION).
2. The Information contained herein is for informational purpose only and is provided only to illustrate the operation of Diodes' products described herein and application examples. Diodes does not assume any liability arising out of the application or use of this document or any product described herein. This document is intended for skilled and technically trained engineering customers and users who design with Diodes' products. Diodes' products may be used to facilitate safety-related applications; however, in all instances customers and users are responsible for (a) selecting the appropriate Diodes products for their applications, (b) evaluating the suitability of Diodes' products for their intended applications, (c) ensuring their applications, which incorporate Diodes' products, comply the applicable legal and regulatory requirements as well as safety and functional-safety related standards, and (d) ensuring they design with appropriate safeguards (including testing, validation, quality control techniques, redundancy, malfunction prevention, and appropriate treatment for aging degradation) to minimize the risks associated with their applications.
3. Diodes assumes no liability for any application-related information, support, assistance or feedback that may be provided by Diodes from time to time. Any customer or user of this document or products described herein will assume all risks and liabilities associated with such use, and will hold Diodes and all companies whose products are represented herein or on Diodes' websites, harmless against all damages and liabilities.
4. Products described herein may be covered by one or more United States, international or foreign patents and pending patent applications. Product names and markings noted herein may also be covered by one or more United States, international or foreign trademarks and trademark applications. Diodes does not convey any license under any of its intellectual property rights or the rights of any third parties (including third parties whose products and services may be described in this document or on Diodes' website) under this document.
5. Diodes' products are provided subject to Diodes' Standard Terms and Conditions of Sale (<https://www.diodes.com/about/company/terms-and-conditions/terms-and-conditions-of-sales/>) or other applicable terms. This document does not alter or expand the applicable warranties provided by Diodes. Diodes does not warrant or accept any liability whatsoever in respect of any products purchased through unauthorized sales channel.
6. Diodes' products and technology may not be used for or incorporated into any products or systems whose manufacture, use or sale is prohibited under any applicable laws and regulations. Should customers or users use Diodes' products in contravention of any applicable laws or regulations, or for any unintended or unauthorized application, customers and users will (a) be solely responsible for any damages, losses or penalties arising in connection therewith or as a result thereof, and (b) indemnify and hold Diodes and its representatives and agents harmless against any and all claims, damages, expenses, and attorney fees arising out of, directly or indirectly, any claim relating to any noncompliance with the applicable laws and regulations, as well as any unintended or unauthorized application.
7. While efforts have been made to ensure the information contained in this document is accurate, complete and current, it may contain technical inaccuracies, omissions and typographical errors. Diodes does not warrant that information contained in this document is error-free and Diodes is under no obligation to update or otherwise correct this information. Notwithstanding the foregoing, Diodes reserves the right to make modifications, enhancements, improvements, corrections or other changes without further notice to this document and any product described herein. This document is written in English but may be translated into multiple languages for reference. Only the English version of this document is the final and determinative format released by Diodes.
8. Any unauthorized copying, modification, distribution, transmission, display or other use of this document (or any portion hereof) is prohibited. Diodes assumes no responsibility for any losses incurred by the customers or users or any third parties arising from any such unauthorized use.
9. This Notice may be periodically updated with the most recent version available at <https://www.diodes.com/about/company/terms-and-conditions/important-notice>

The Diodes logo is a registered trademark of Diodes Incorporated in the United States and other countries.
All other trademarks are the property of their respective owners.
© 2023 Diodes Incorporated. All Rights Reserved.

www.diodes.com