

Description

The DIODES AH1391 is a miniature micropower magnetic Unipolar Hall effect switch IC with dual outputs specifically designed for portable and battery powered consumer equipment to home appliances and industrial applications. To support battery powered equipment and low voltage microcontrollers, the AH1391 can operate over the supply range of 1.6V to 5.5V and uses a sleep function to give an average supply current of only 1.1µA at 1.85V. The AH1391 has a 6kV ESD rating on the supply and output pins. To minimize PCB space the AH1391 are packaged in small low profile X2-DFN1410-4 and X2-DFN1010-4 (Type B).

A North pole of sufficient strength will turn Output1 on and a South pole of sufficient strength will turn on Output2. The Output1 is turned on (pulled low) when the magnetic flux density (B), perpendicular to the part marking surface, falls below North field operate point B_{OPN} (-25G typical). The Output1 is held low until B rises above the North field release point B_{RPN} (-20G typical). Similarly, the Output2 will operate (pulled low) when B to the part marking surface rises above South field operate point B_{OPS} (25G typical) and is held low until B falls below the South field release point B_{RPS} (20G typical).

Features

- Two Monolithic Unipolar Hall Switches
 - Operation with a North Pole (Output1) to Part Marking Surface
 - Operation with a South Pole (Output2) to Part Marking Surface
- Supply Voltage of 1.6V to 5.5V
- Micropower Operation
- Dual Outputs for Independent Pole Detection for Design Flexibility
- Internal Pull up and Pull Down Capability
- Chopper Stabilized Design
 - Superior Temperature Stability
 - Extremely Low Switch-Point Drift
 - Insensitive to Physical Stress
- Good RF Noise Immunity
- Operating Temperature Range -40°C to +85°C
- 6kV ESD on Supply and Output Pins
- Small Low Profile X2-DFN1410-4 and X2-DFN1010-4 (Type B)
- **Totally Lead-Free & Fully RoHS Compliant (Notes 1 & 2)**
- **Halogen and Antimony Free. "Green" Device (Note 3)**
- **For automotive applications requiring specific change control (i.e. parts qualified to AEC-Q100/101/104/200, PPAP capable, and manufactured in IATF 16949 certified facilities), please [contact us](mailto:contact@diodes.com) or your local Diodes representative.**
<https://www.diodes.com/quality/product-definitions/>

Notes: 1. No purposely added lead. Fully EU Directive 2002/95/EC (RoHS), 2011/65/EU (RoHS 2) & 2015/863/EU (RoHS 3) compliant.
 2. See <https://www.diodes.com/quality/lead-free/> for more information about Diodes Incorporated's definitions of Halogen- and Antimony-free, "Green" and Lead-free.
 3. Halogen- and Antimony-free "Green" products are defined as those which contain <900ppm bromine, <900ppm chlorine (<1500ppm total Br + Cl) and <1000ppm antimony compounds.

Pin Assignments

(Top View)

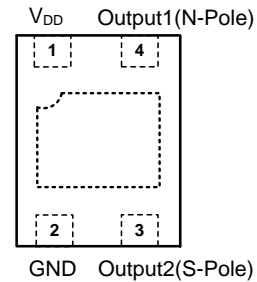

X2-DFN1410-4

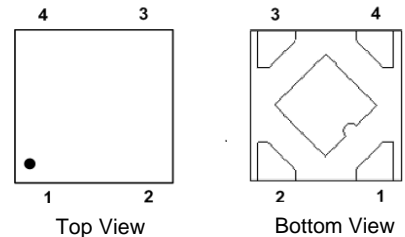

X2-DFN1010-4 (Type B)

PIN1 – V_{DD} , PIN2 – GND,

PIN3 –Output2(S-Pole), PIN4 –Output1(N-Pole)

Applications

- Smart cover or dock detect for cellular phones and tablets
- Position detect for digital stills, video cameras and handheld gaming consoles
- Doors, lids and tray position detect switches home appliances and industrial applications
- Levels, proximities and position switches
- Contact-less switches in home appliances and industrial applications

Typical Applications Circuit

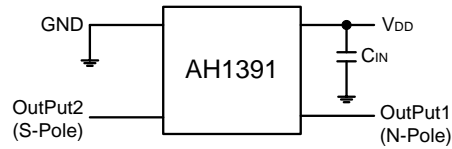

Note: 4. C_{IN} is for power stabilization and to strengthen the noise immunity, the recommended capacitance is 100nF typical and should be placed as close to the supply pin as possible.

Pin Descriptions

Package: X2-DFN1410-4 , X2-DFN1010-4 (Type B)

Pin Number	Pin Name	Function
1	V _{DD}	Power Supply Input
2	GND	Ground Pin
3	Output2	Output Pin (South-Pole)
4	Output1	Output Pin (North-Pole)
Pad	Pad	The center exposed pad should be tied to the GND or floating – No connection internally.

Functional Block Diagram

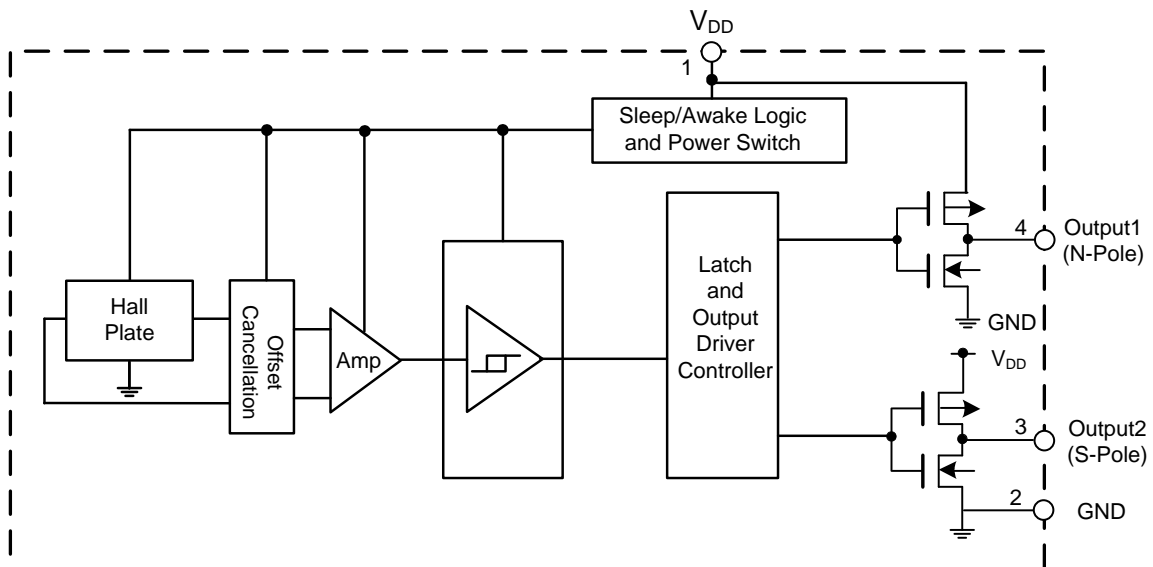

Absolute Maximum Ratings (Note 5) (@ $T_A = +25^\circ\text{C}$, unless otherwise specified.)

Symbol	Parameter	Values	Unit	
V_{DD}	Supply Voltage (Note 6)	6	V	
V_{DD_REV}	Reverse Supply Voltage	-0.3	V	
I_{OUTPUT}	Output Current (Source and Sink)	2.5	mA	
B	Magnetic Flux Density	Unlimited		
P_D	Package Power Dissipation	X2-DFN1410-4	230	mW
		X2-DFN1010-4 (Type B)		
T_{STG}	Storage Temperature Range	-65 to +150	$^\circ\text{C}$	
T_J	Maximum Junction Temperature	+150	$^\circ\text{C}$	
ESD HBM	Human Body Model ESD Capability	6	kV	

- Notes:
- Stresses greater than the "Absolute Maximum Ratings" specified above can cause permanent damage to the device. These are stress ratings only; functional operation of the device at these or any other conditions exceeding those indicated in this specification is not implied. Device reliability can be affected by exposure to "Absolute Maximum Ratings" conditions for extended periods of time.
 - The absolute maximum V_{DD} of 6V is a transient stress rating and is not meant as a functional operating condition. It is not recommended to operate the device at the absolute maximum rated conditions for any period of time.

Recommended Operating Conditions (@ $T_A = +25^\circ\text{C}$, unless otherwise specified.)

Symbol	Parameter	Conditions	Rating	Unit
V_{DD}	Supply Voltage	Operating	1.6 to 5.5	V
T_A	Operating Temperature Range	Operating	-40 to +85	$^\circ\text{C}$

Electrical Characteristics (@ $T_A = +25^\circ\text{C}$, $V_{DD} = 3\text{V}$, unless otherwise specified.)

Symbol	Parameter	Conditions	Min	Typ	Max	Unit
V_{OL}	Output Low Voltage (On)	$I_{OUT} = 1\text{mA}$	—	0.15	0.25	V
V_{OH}	Output High Voltage (Off)	$I_{OUT} = -1\text{mA}$	$V_{DD}-0.25$	$V_{DD}-0.15$	—	V
$I_{DD(AWAKE)}$	Supply Current	$T_A = +25^\circ\text{C}$, $V_{DD} = 1.85\text{V}$	—	720	—	μA
$I_{DD(SLEEP)}$	Supply Current	$T_A = +25^\circ\text{C}$, $V_{DD} = 1.85\text{V}$	—	0.36	1	μA
$I_{DD(AVG)}$	Average Supply Current	$T_A = +25^\circ\text{C}$, $V_{DD} = 1.85\text{V}$	—	1.1	3	μA
		$T_A = -40$ to $+85^\circ\text{C}$, $V_{DD} = 1.6\text{V}$ to 5.5V	—	1.1	9	μA
t_{AWAKE}	Awake Time	(Note 7)	30	45	80	μs
t_{PERIOD}	Period	(Note 7)	30	45	80	ms
D.C.	Duty Cycle	—	—	0.1	—	%

- Note:
- When power is initially turned on, the operating V_{DD} (1.6V to 5.5V) must be applied to guaranteed the output sampling. The output state is valid after the second operating cycle (typical 90ms).

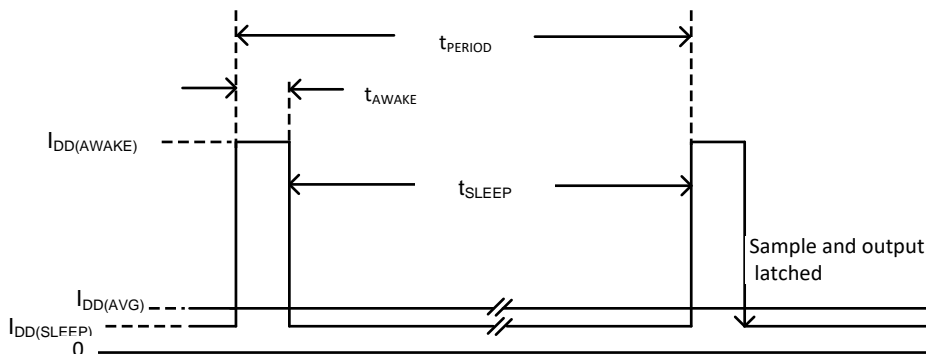

Magnetic Characteristics (Notes 8 & 9) ($T_A = +25^\circ\text{C}$, $V_{DD} = 1.85\text{V}$, unless otherwise specified.)

Standard convention for representing the direction of magnetic field strength and flux density by positive and negative signs is as follows: Magnetic field and flux density from South pole magnet to the part marking surface of the sensor is positive. Magnetic field and flux density from the North pole magnet to the part marking surface is negative field. The positive and negative signs in below graph follow this standard convention. The positive and negative signs in the table below follow this standard convention.

(1mT = 10 Gauss)

Symbol	Characteristics	Test Condition	Min	Typ	Max	Unit
B_{OPS} (South Pole to Part Marking Side) Output2	Output2 Operation Point	$T_A = +25^\circ\text{C}$	17	25	35	Gauss
		$T_A = -40^\circ\text{C to } +85^\circ\text{C}$	13	25	39	
B_{OPN} (North Pole to Part Marking Side) Output1	Output1 Operation Point	$T_A = +25^\circ\text{C}$	-35	-25	-17	
		$T_A = -40^\circ\text{C to } +85^\circ\text{C}$	-39	-25	-13	
B_{RPS} (South Pole to Part Marking Side) Output2	Output2 Release Point	$T_A = +25^\circ\text{C}$	11	20	30	
		$T_A = -40^\circ\text{C to } +85^\circ\text{C}$	7	20	34	
B_{RPN} (North Pole to Part Marking Side) Output1	Output1 Release Point	$T_A = +25^\circ\text{C}$	-30	-20	-11	
		$T_A = -40^\circ\text{C to } +85^\circ\text{C}$	-34	-20	-7	
B_{HY} ($ B_{OPX} - B_{RPX} $)	Hysteresis (Note 10)	$T_A = -40^\circ\text{C to } +85^\circ\text{C}$	1	5	—	

- Notes:
- Typical data is at $T_A = +25^\circ\text{C}$, $V_{DD} = 1.85\text{V}$.
 - Maximum and minimum parameter values over operating temperature range are not tested in production, they are guaranteed by design, characterization and process control. The magnetic characteristics may vary with supply voltage, operating temperature and after soldering.
 - Typical and minimum hysteresis is guaranteed by design and characterization.

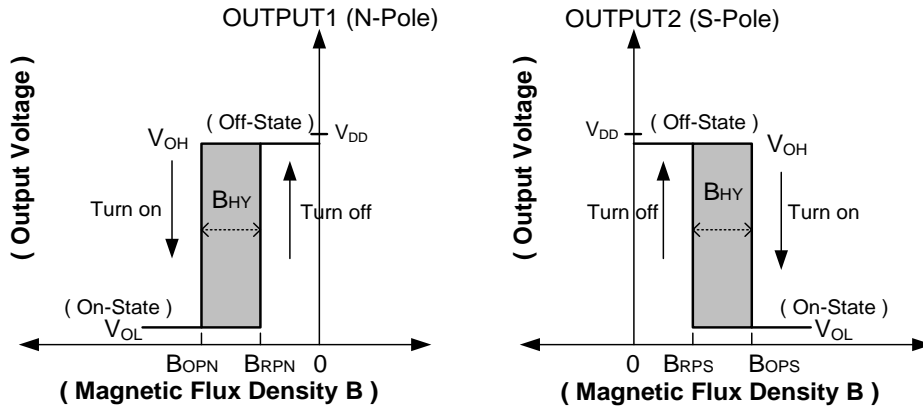

X2-DFN1410-4
X2-DFN1010-4 (Type B)

Typical Operating Characteristics

Average Supply Current $I_{DD(AVG)}$

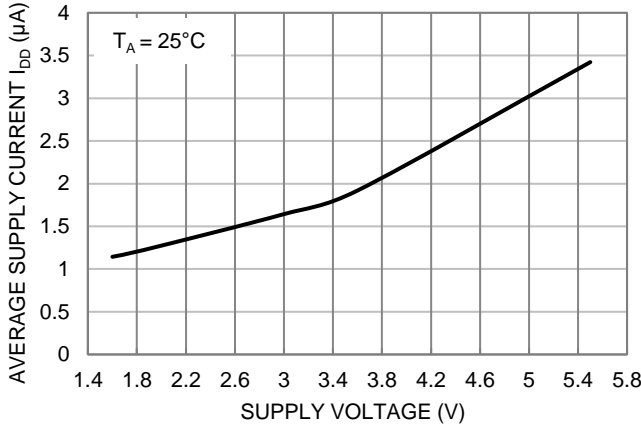

Figure 1. $I_{DD(AVG)}$ vs. Supply Voltage

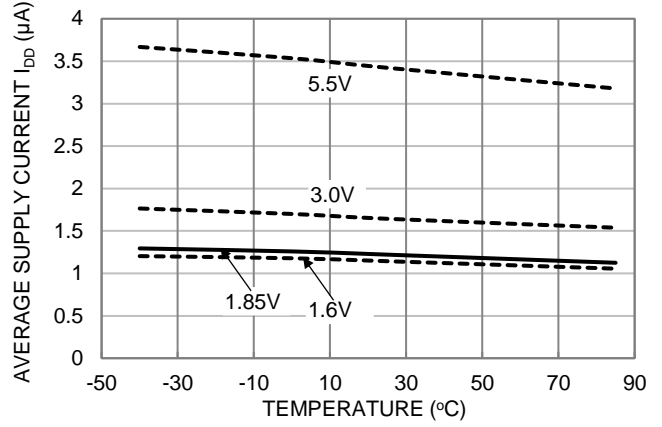

Figure 2. $I_{DD(AVG)}$ vs. Temperature

Output Low Voltage (On) V_{OL} , $I_{OUT} = 1mA$

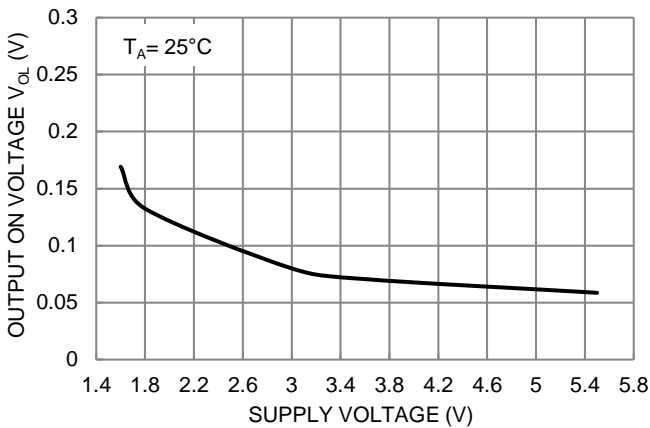

Figure 3. Output On Voltage vs. Supply Voltage

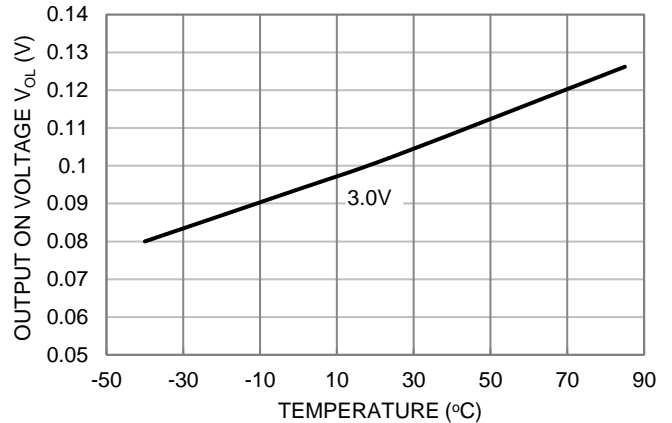

Figure 4. Output On Voltage vs. Temperature

Output High Voltage (Off) V_{OH} , $I_{OUT} = -1mA$

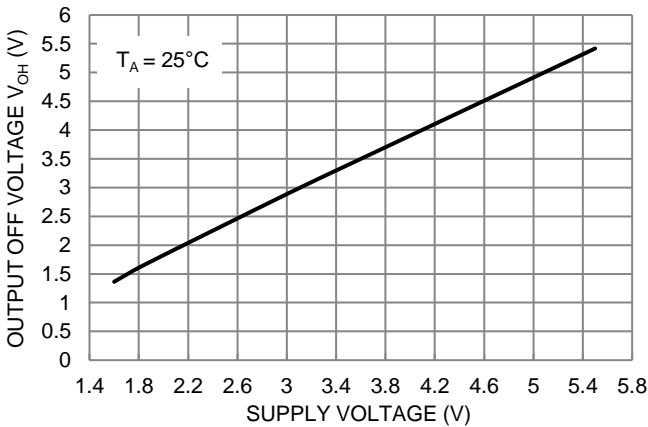

Figure 5. Output Off Voltage vs. Supply Voltage

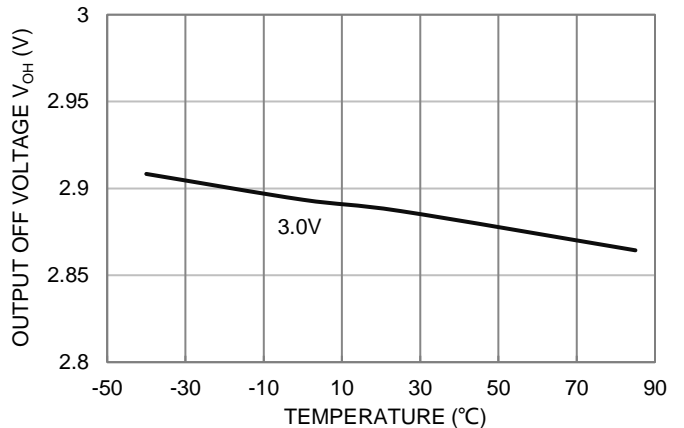

Figure 6. Output Off Voltage vs. Temperature

Typical Operating Characteristics (continued)

Switch point B_{OP}/B_{RP} and Hysteresis B_{HY}

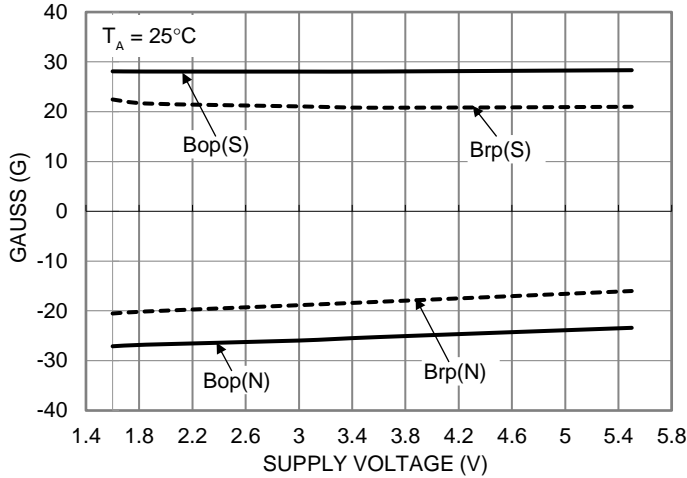

Figure 7. Switch Points vs Supply Voltage

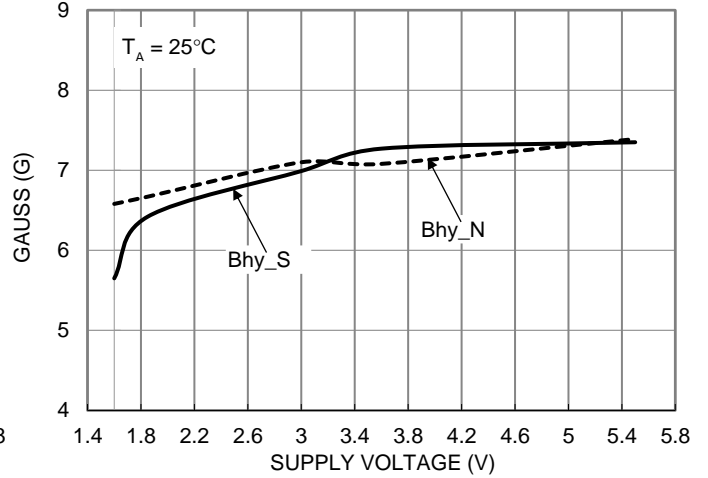

Figure 8. Hysteresis B_{HY} vs Supply Voltage

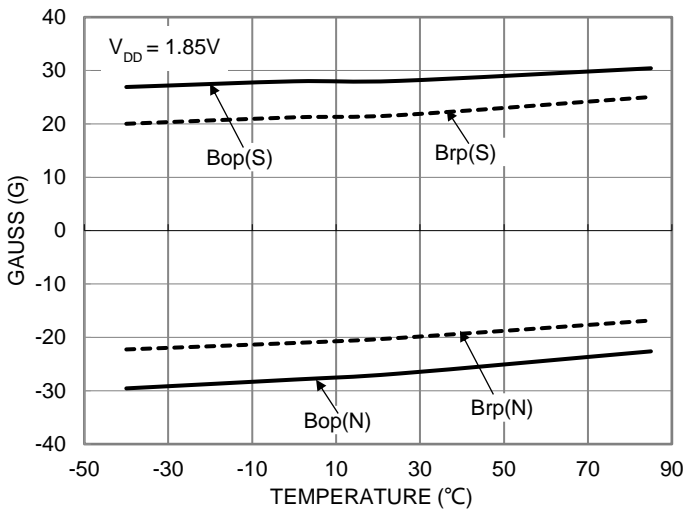

Figure 9. Switch Points vs Temperature

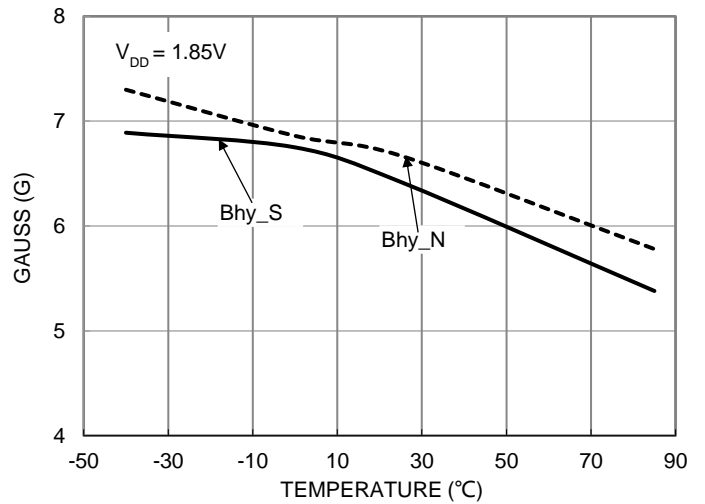
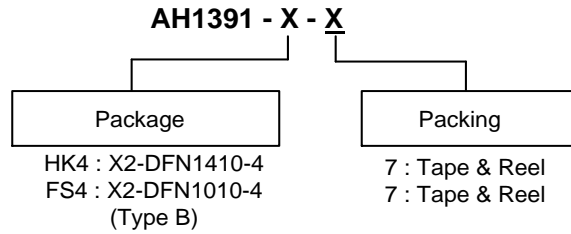

Figure 10. Hysteresis B_{HY} vs Supply Voltage

Ordering Information



Part Number	Package	Marking Code	Packing	
			Qty.	Carrier
AH1391-HK4-7	X2-DFN1410-4	HK4	4000	7" Tape and Reel
AH1391-FS4-7	X2-DFN1010-4 (Type B)	FS4	5000	7" Tape and Reel

Marking Information

(1) Package Type: X2-DFN1410-4

(Top View)

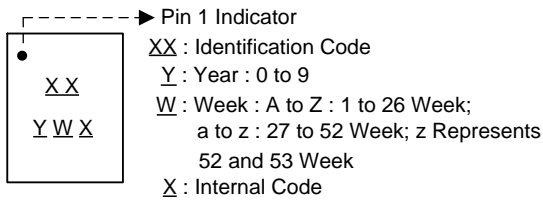

Part Number	Package	Identification Code
AH1391-HK4-7	X2-DFN1410-4	FA

(2) Package Type: X2-DFN1010-4 (Type B)

(Top View)

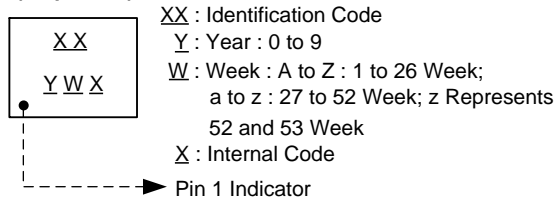

Part Number	Package	Identification Code
AH1391-FS4-7	X2-DFN1010-4 (Type B)	FB

Package Outline Dimensions

Please see <http://www.diodes.com/package-outlines.html> for the latest version.

(1) Package Type: X2-DFN1410-4

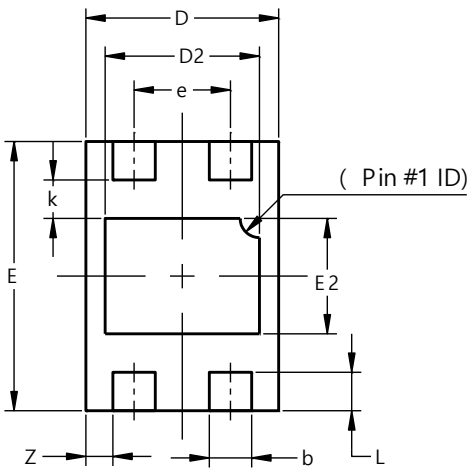
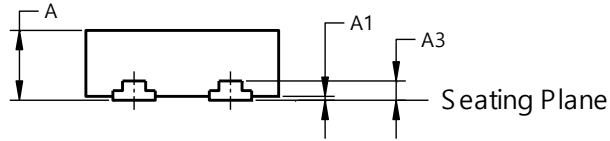

X2-DFN1410-4			
Dim	Min	Max	Typ
A	--	0.40	0.37
A1	0.00	0.05	0.02
A3	--	--	0.100
b	0.17	0.27	0.22
D	0.95	1.05	1.00
D2	0.70	0.90	0.80
E	1.35	1.45	1.40
E2	0.50	0.70	0.60
e	0.50BSC		
k	--	--	0.20
L	0.15	0.25	0.20
z	--	--	0.14
All Dimensions in mm			

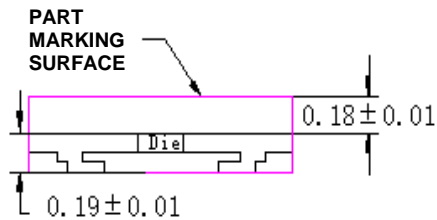
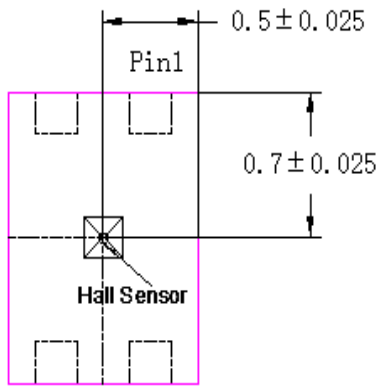

Top View

Side View

Sensor Location

Package Outline Dimensions (continued)

Please see <http://www.diodes.com/package-outlines.html> for the latest version.

(2) Package Type: X2-DFN1010-4 (Type B)

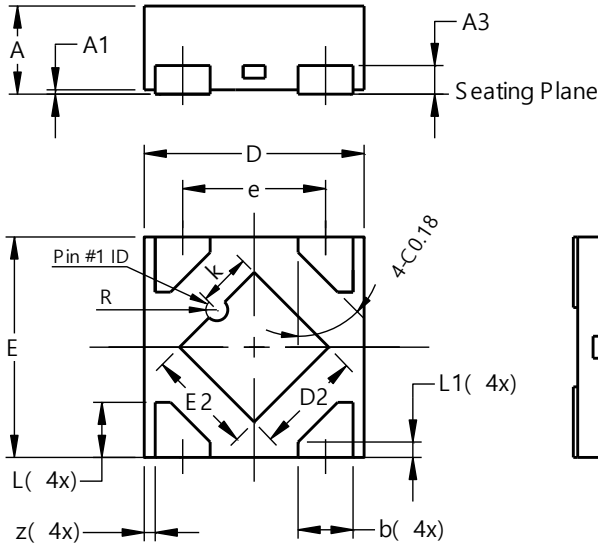

X2-DFN1010-4 (Type B)			
Dim	Min	Max	Typ
A	-	0.40	0.39
A1	0.00	0.05	0.02
A3	-	-	0.13
b	0.20	0.30	0.25
D	0.95	1.05	1.00
D2	0.43	0.53	0.48
E	0.95	1.05	1.00
E2	0.43	0.53	0.48
e	-	-	0.65
k	0.19	0.29	0.24
L	0.20	0.30	0.25
L1	0.02	0.12	0.07
R	0.02	0.08	0.05
z	-	-	0.050
All Dimensions in mm			

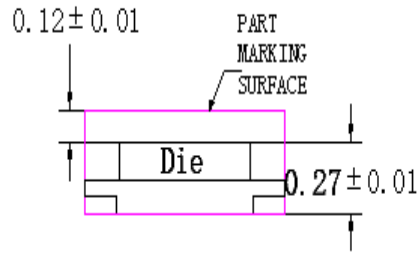
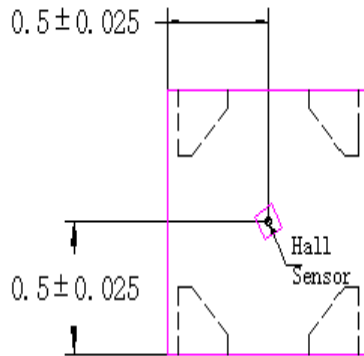

Top View

Side View

Sensor Location

Suggested Pad Layout

Please see <http://www.diodes.com/package-outlines.html> for the latest version.

(1) Package Type: X2-DFN1410-4

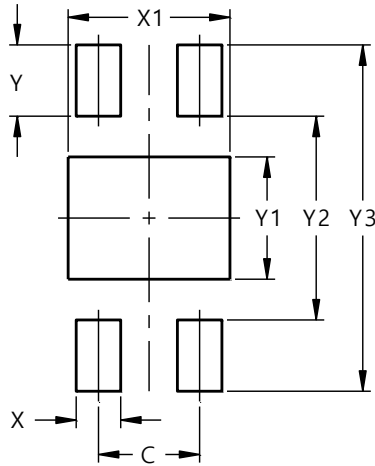

Dimensions	Value (in mm)
C	0.50
X	0.22
X1	0.80
Y	0.35
Y1	0.60
Y2	1.00
Y3	1.70

(2) Package Type: X2-DFN1010-4 (Type B)

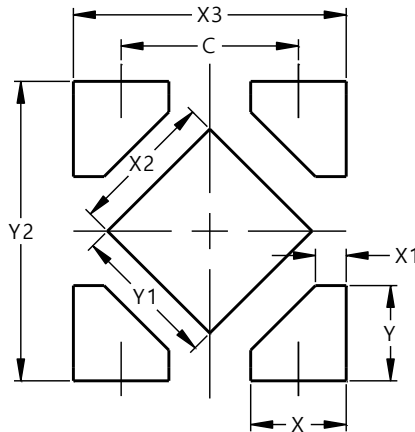

Dimensions	Value (in mm)
C	0.650
X	0.350
X1	0.112
X2	0.530
X3	1.00
Y	0.350
Y1	0.530
Y2	1.100

Mechanical Data

- Moisture Sensitivity: Level 1 per J-STD-020
- Terminals: Finish – Matte Tin Plated Leads, Solderable per MIL-STD-202, Method 208 ③
- Weight: Package X2-DFN1010-4 (Type B): 0.001 grams (Approximate)
Package X2-DFN1410-4: 0.002 grams (Approximate)

IMPORTANT NOTICE

1. DIODES INCORPORATED (Diodes) AND ITS SUBSIDIARIES MAKE NO WARRANTY OF ANY KIND, EXPRESS OR IMPLIED, WITH REGARDS TO ANY INFORMATION CONTAINED IN THIS DOCUMENT, INCLUDING, BUT NOT LIMITED TO, THE IMPLIED WARRANTIES OF MERCHANTABILITY, FITNESS FOR A PARTICULAR PURPOSE OR NON-INFRINGEMENT OF THIRD PARTY INTELLECTUAL PROPERTY RIGHTS (AND THEIR EQUIVALENTS UNDER THE LAWS OF ANY JURISDICTION).
2. The Information contained herein is for informational purpose only and is provided only to illustrate the operation of Diodes' products described herein and application examples. Diodes does not assume any liability arising out of the application or use of this document or any product described herein. This document is intended for skilled and technically trained engineering customers and users who design with Diodes' products. Diodes' products may be used to facilitate safety-related applications; however, in all instances customers and users are responsible for (a) selecting the appropriate Diodes products for their applications, (b) evaluating the suitability of Diodes' products for their intended applications, (c) ensuring their applications, which incorporate Diodes' products, comply the applicable legal and regulatory requirements as well as safety and functional-safety related standards, and (d) ensuring they design with appropriate safeguards (including testing, validation, quality control techniques, redundancy, malfunction prevention, and appropriate treatment for aging degradation) to minimize the risks associated with their applications.
3. Diodes assumes no liability for any application-related information, support, assistance or feedback that may be provided by Diodes from time to time. Any customer or user of this document or products described herein will assume all risks and liabilities associated with such use, and will hold Diodes and all companies whose products are represented herein or on Diodes' websites, harmless against all damages and liabilities.
4. Products described herein may be covered by one or more United States, international or foreign patents and pending patent applications. Product names and markings noted herein may also be covered by one or more United States, international or foreign trademarks and trademark applications. Diodes does not convey any license under any of its intellectual property rights or the rights of any third parties (including third parties whose products and services may be described in this document or on Diodes' website) under this document.
5. Diodes' products are provided subject to Diodes' Standard Terms and Conditions of Sale (<https://www.diodes.com/about/company/terms-and-conditions/terms-and-conditions-of-sales/>) or other applicable terms. This document does not alter or expand the applicable warranties provided by Diodes. Diodes does not warrant or accept any liability whatsoever in respect of any products purchased through unauthorized sales channel.
6. Diodes' products and technology may not be used for or incorporated into any products or systems whose manufacture, use or sale is prohibited under any applicable laws and regulations. Should customers or users use Diodes' products in contravention of any applicable laws or regulations, or for any unintended or unauthorized application, customers and users will (a) be solely responsible for any damages, losses or penalties arising in connection therewith or as a result thereof, and (b) indemnify and hold Diodes and its representatives and agents harmless against any and all claims, damages, expenses, and attorney fees arising out of, directly or indirectly, any claim relating to any noncompliance with the applicable laws and regulations, as well as any unintended or unauthorized application.
7. While efforts have been made to ensure the information contained in this document is accurate, complete and current, it may contain technical inaccuracies, omissions and typographical errors. Diodes does not warrant that information contained in this document is error-free and Diodes is under no obligation to update or otherwise correct this information. Notwithstanding the foregoing, Diodes reserves the right to make modifications, enhancements, improvements, corrections or other changes without further notice to this document and any product described herein. This document is written in English but may be translated into multiple languages for reference. Only the English version of this document is the final and determinative format released by Diodes.
8. Any unauthorized copying, modification, distribution, transmission, display or other use of this document (or any portion hereof) is prohibited. Diodes assumes no responsibility for any losses incurred by the customers or users or any third parties arising from any such unauthorized use.
9. This Notice may be periodically updated with the most recent version available at <https://www.diodes.com/about/company/terms-and-conditions/important-notice>

The Diodes logo is a registered trademark of Diodes Incorporated in the United States and other countries.
All other trademarks are the property of their respective owners.
© 2023 Diodes Incorporated. All Rights Reserved.

www.diodes.com