

2 CHANNEL LOW CAPACITANCE BI-DIRECTIONAL TVS ARRAY
Features

- Provides ESD Protection per IEC 61000-4-2 Standard: Air – ±30kV, Contact – ±30kV
- 2 Channels of Bi-Directional ESD Protection
- Low Channel Input Capacitance
- Typically Used in Cellular Handsets, Portable Electronics, Communication Systems, Computers and Peripherals
- **Lead Free/RoHS Compliant (Note 1)**
- **“Green” Device (Note 2)**

Mechanical Data

- Case: SOT23
- Case Material: Molded Plastic, “Green” Molding Compound. UL Flammability Classification Rating 94V-0
- Moisture Sensitivity: Level 1 per J-STD-020
- Terminals: Matte Tin Finish annealed over Alloy 42 leadframe (Lead Free Plating). Solderable per MIL-STD-202, Method 208
- Weight: 0.0089 grams (approximate)



Top View

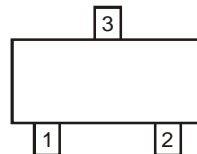

Pin Configuration

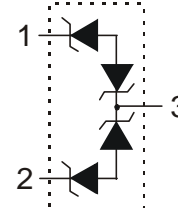

Device Schematic

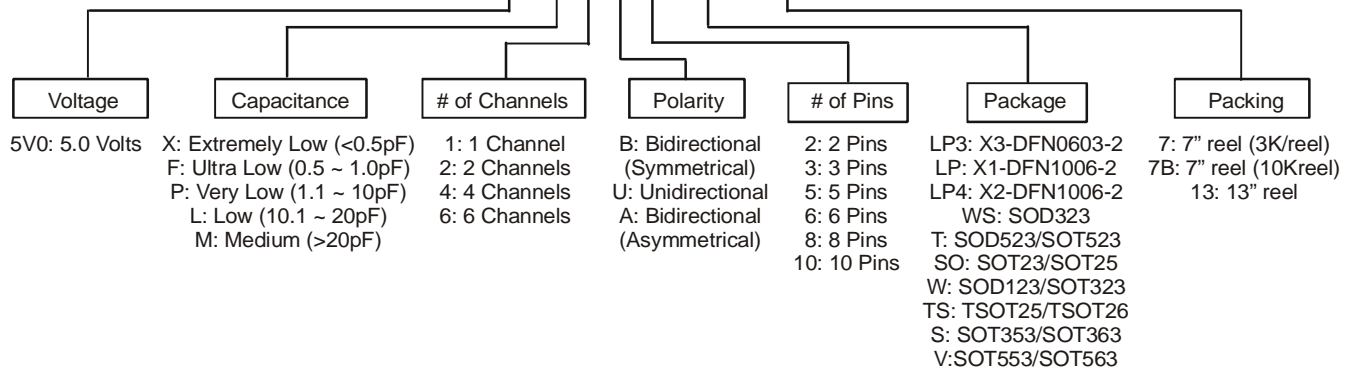
Ordering Information (Note 3)
D 5V0 L X B X XXX- XX

Part Number	Case	Packaging
D5V0L2B3SO-7	SOT23	3000/Tape & Reel

- Notes:
1. EU Directive 2002/95/EC (RoHS) & 2011/65/EU (RoHS 2) compliant. No purposely added lead. Halogen and Antimony free.
 2. Diodes Inc.'s "Green" policy can be found on our website at <http://www.diodes.com>.
 3. For packaging details, go to our website at <http://www.diodes.com>.

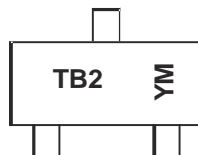
Marking Information

TB2 = Product Type Marking Code
 YM = Date Code Marking
 Y = Year (ex: Z = 2012)
 M = Month (ex: 9 = September)

Date Code Key

Year	2011	2012	2013	2014	2015	2016	2017
Code	Y	Z	A	B	C	D	E

Month	Jan	Feb	Mar	Apr	May	Jun	Jul	Aug	Sep	Oct	Nov	Dec
Code	1	2	3	4	5	6	7	8	9	O	N	D

Maximum Ratings @T_A = 25°C unless otherwise specified

Characteristic	Symbol	Value	Unit	Conditions
Peak Pulse Power Dissipation	P _{PP}	84	W	8/20μs, Per in Fig. 1
Peak Pulse Current	I _{PP}	6	A	8/20μs, Per in Fig. 1
ESD Protection – Contact Discharge	V _{ESD_Contact}	±30	kV	Standard IEC 61000-4-2
ESD Protection – Air Discharge	V _{ESD_Air}	±30	kV	Standard IEC 61000-4-2

Thermal Characteristics

Characteristic	Symbol	Value	Unit
Package Power Dissipation (Note 5)	P _D	300	mW
Thermal Resistance, Junction to Ambient (Note 5)	R _{θJA}	417	°C/W
Operating Junction Temperature Range	T _J	-65 to +150	°C
Storage Temperature Range	T _{STG}	-65 to +150	°C

Electrical Characteristics @T_A = 25°C unless otherwise specified

Characteristic	Symbol	Min	Typ	Max	Unit	Test Conditions
Reverse Working Voltage	V _{RWM}	-	-	5.0	V	-
Breakdown Voltage	V _{BR}	6	7	8	V	I _R = 1.0mA
Reverse Leakage Current (Note 6)	I _R	-	10	100	nA	V _{RWM} = 5V
Clamping Voltage (Note 4)	V _{CL}	-	7.0	9.0	V	I _{PP} = 1A, t _p = 8/20μs
		-	8.7	10.7	V	I _{PP} = 3A, t _p = 8/20μs
		-	10.5	12.0	V	I _{PP} = 5A, t _p = 8/20μs
		-	11.5	14.0	V	I _{PP} = 6A, t _p = 8/20μs
Differential Resistance	R _{DIF}	-	0.2	-	Ω	I _R = 1.0A, t _p = 8/20μs
Channel Input Capacitance	C _T	-	15	20	pF	V _{IN} = 0V, f = 1MHz (Channel to Pin 3)

- Notes:
4. Measured from channel to pin 3; Non-repetitive current pulse per Fig. 1.
 5. Device mounted on FR-4 PCB pad layout (2oz copper) as shown on Diodes, Inc. suggested pad layout AP02001, which can be found on our website at <http://www.diodes.com>.
 6. Short duration pulse test used to minimize self-heating effect.

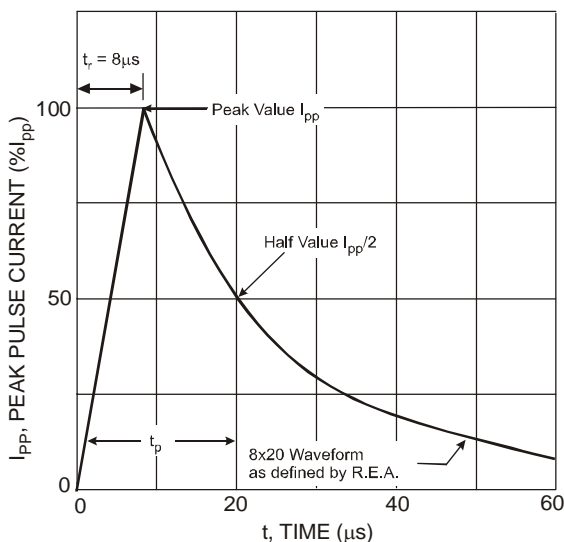

Fig. 1 Typical 8 x 20μs Pulse Waveform

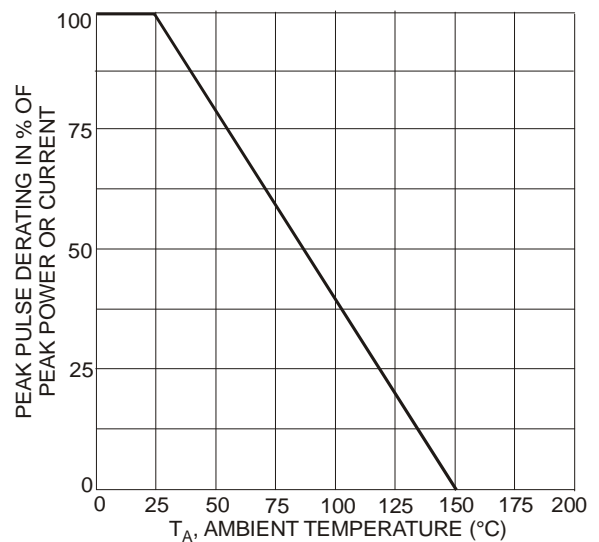

Fig. 2 Pulse Derating Curve

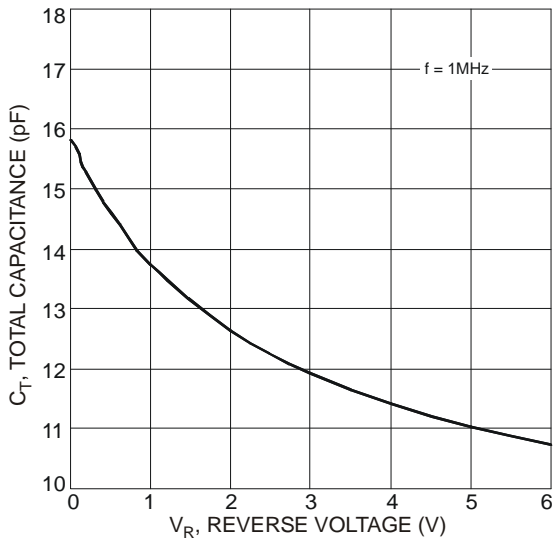

Fig. 3 Typical Total Capacitance vs. Reverse Voltage

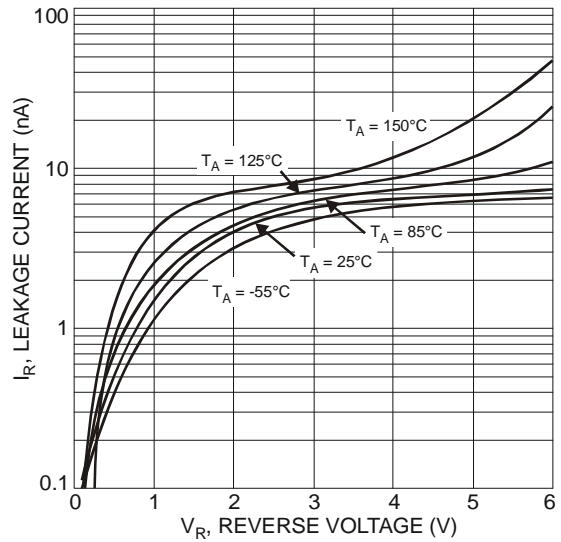
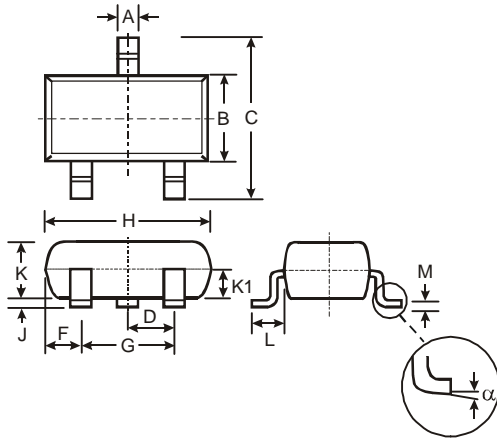

Fig. 4 Typical Reverse Characteristics

Package Outline Dimensions



SOT23			
Dim	Min	Max	Typ
A	0.37	0.51	0.40
B	1.20	1.40	1.30
C	2.30	2.50	2.40
D	0.89	1.03	0.915
F	0.45	0.60	0.535
G	1.78	2.05	1.83
H	2.80	3.00	2.90
J	0.013	0.10	0.05
K	0.903	1.10	1.00
K1	-	-	0.400
L	0.45	0.61	0.55
M	0.085	0.18	0.11
α	0°	8°	-
All Dimensions in mm			

Suggested Pad Layout

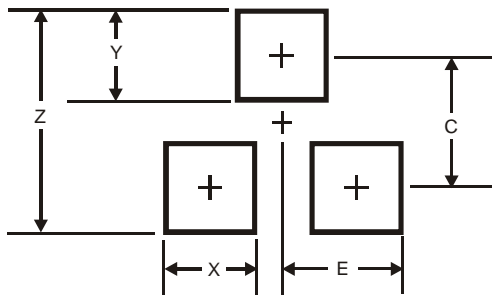

Dimensions	Value (in mm)
Z	2.9
X	0.8
Y	0.9
C	2.0
E	1.35

IMPORTANT NOTICE

DIODES INCORPORATED MAKES NO WARRANTY OF ANY KIND, EXPRESS OR IMPLIED, WITH REGARDING TO THIS DOCUMENT, INCLUDING, BUT NOT LIMITED TO, THE IMPLIED WARRANTIES OF MERCHANTABILITY AND FITNESS FOR A PARTICULAR PURPOSE (AND THEIR EQUIVALENTS UNDER THE LAWS OF ANY JURISDICTION).

Diodes Incorporated and its subsidiaries reserve the right to make modifications, enhancements, improvements, corrections or other changes without further notice to this document and any product described herein. Diodes Incorporated does not assume any liability arising out of the application or use of this document or any product described herein; neither does Diodes Incorporated convey any license under its patent or trademark rights, nor the rights of others. Any Customer or user of this document or products described herein in such applications shall assume all risks of such use and will agree to hold Diodes Incorporated and all the companies whose products are represented on Diodes Incorporated website, harmless against all damages.

Diodes Incorporated does not warrant or accept any liability whatsoever in respect of any products purchased through unauthorized sales channel. Should Customers purchase or use Diodes Incorporated products for any unintended or unauthorized application, Customers shall indemnify and hold Diodes Incorporated and its representatives harmless against all claims, damages, expenses, and attorney fees arising out of, directly or indirectly, any claim of personal injury or death associated with such unintended or unauthorized application.

Products described herein may be covered by one or more United States, international or foreign patents pending. Product names and markings noted herein may also be covered by one or more United States, international or foreign trademarks.

LIFE SUPPORT

Diodes Incorporated products are specifically not authorized for use as critical components in life support devices or systems without the express written approval of the Chief Executive Officer of Diodes Incorporated. As used herein:

A. Life support devices or systems are devices or systems which:

1. are intended to implant into the body, or
2. support or sustain life and whose failure to perform when properly used in accordance with instructions for use provided in the labeling can be reasonably expected to result in significant injury to the user.

B. A critical component is any component in a life support device or system whose failure to perform can be reasonably expected to cause the failure of the life support device or to affect its safety or effectiveness.

Customers represent that they have all necessary expertise in the safety and regulatory ramifications of their life support devices or systems, and acknowledge and agree that they are solely responsible for all legal, regulatory and safety-related requirements concerning their products and any use of Diodes Incorporated products in such safety-critical, life support devices or systems, notwithstanding any devices- or systems-related information or support that may be provided by Diodes Incorporated. Further, Customers must fully indemnify Diodes Incorporated and its representatives against any damages arising out of the use of Diodes Incorporated products in such safety-critical, life support devices or systems.

Copyright © 2012, Diodes Incorporated

www.diodes.com