

ZXLD1350EV7



ZXLD1350EV7 EVALUATION BOARD USER GUIDE

DESCRIPTION

The ZXLD1350EV7, Figure 1, is an evaluation board for evaluating the ZXLD1350 350mA LED driver with internal switch. The evaluation board can be used to drive 1, 2 or 3 one-watt LEDs, or an external choice of LEDs. The number of external connected LEDs depends on the forward voltage of the LEDs connected. The LEDs fitted on this evaluation board are from the Luxeon® range.

The operating voltage is nominally 24V. For three 1W series-connected LEDs, the voltage can be from 12V minimum to 30V maximum. The 100uH inductor used in the circuit is based on a nominal 24V supply, which should be connected across +VIN and GND pins. Note: The evaluation board does not have reverse battery protection. The nominal current for the evaluation board is set at 300mA with a 0.33Ω sense resistor, Rs.

Jumpers J1, J2 and J3 allow the selection of the number of LEDs to be connected in series. Jumper on at J1 bypasses LED D1. Jumper on at J3 bypasses LED D3. Removing jumper J2 disconnects all the on-board LEDs from the current flow path. Jumper 2 also doubles as a connection point for an ammeter to measure the LED current.

Before connecting external LEDs across test pins LED+ and LED-, or across J1, remove jumper J2. Jumpers J1 and J2 can be on or off.

Test point ADJ provides a connection point for DC or PWM dimming and shutdown.

Warning: At 24V nominal operation with 300mA output, the LEDs and the PCB may be hot and the LEDs will be very bright.

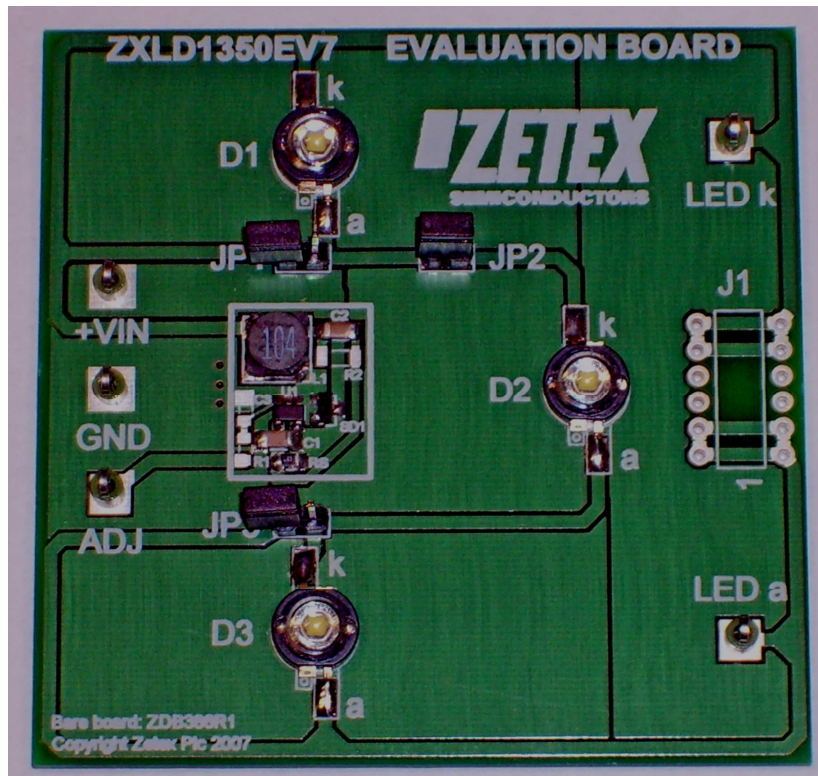

Figure 1: ZXLD1350EV7 evaluation board

ZXLD1350EV7

ZXLD1350 DEVICE DESCRIPTION

The ZXLD1350 is a continuous mode inductive driver in a TSOT23-5 package, for driving one or more series connected LEDs efficiently from a voltage source higher than the LED voltage. The device includes the output switch and a current sense circuit, which requires an external sense resistor to set the nominal current up to 350mA.

ZXLD1350 DEVICE FEATURES

- Drives one or more series-connected 1W white LEDs up to 350mA.
- Internal 30V switch.
- Wide input voltage: 7V to 30V.
- Inherent open circuit LED protection.
- Brightness control using DC or PWM.
- Internal PWM filter.

DEVICE APPLICATIONS

- LED flashlights.
- High Power LED driving.
- Low-voltage halogen replacement LEDs.
- Automotive lighting.
- Illuminated signs.

ZXLD1350 Device Packages, Pin and Definitions

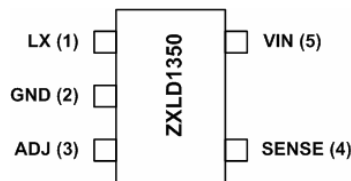

TSOT23-5 pack

ZXLD1350 Device Pin Definition

Name	Pin No	Description
LX	1	Drain of NDMOS switch.
GND	2	Ground (0V).
ADJ	3	Internal voltage ref. pin (1.25V) : <ul style="list-style-type: none"> • Leave floating for normal operation. • Connect to GND to turn off output current. • Drive with DC voltage (0.3V to 1.25V) or with PWM signal to adjust output current or.... • Connect a capacitor from this pin to ground to set soft-start time.
ISENSE	4	Connect a sense resistor, R_s , from the ADJ pin to VIN to sense the nominal output current. Nominal $I_{out} = 0.1 / R_s$
VIN	5	Input voltage: 7V to 30V. Decouple to ground with a 1uF or higher ceramic capacitor.

ORDERING INFORMATION

EVALBOARD ORDER NUMBER
ZXLD1350EV7

DEVICE ORDER NUMBER
ZXLD1350E5TA

Please note: Evaluation boards are subject to availability and qualified leads.

ZXLD1350EV7



ZXLD1350EV7 EVALUATION BOARD REFERENCE DESIGN

The ZXLD1350EV7 is configured to the reference design in Figure 2. The target application is a driver for one or more series-connected 1W white LEDs for torches and other high powered LED driving applications.

The operating voltage is a nominal 24V. For three 1W series-connected LEDs, the voltage can be from 12V minimum to 30V maximum. The nominal current is set at 300mA with a 0.33Ω sense resistor, Rs. For three series-connected 1-watt LEDs, with a nominal supply of 24V, the ZXLD1350 runs in continuous mode at 545kHz, with a 100uH inductor.

Jumpers J1, J2 and J3 allow selection of the number of LEDs to be connected in series. Jumper on at J1 bypasses LED D1. Jumper on at J3 bypasses LED D3. Removing jumper J2 disconnects all the 1-watt LEDs from the current flow path. Jumper 2 also doubles as a connection point for an ammeter to measure the LED current.

Both DC and PWM dimming can be achieved by driving the ADJ pin. For DC dimming, the ADJ pin may be driven between 0.3V and 1.25V. Driving the ADJ pin below 0.2V will shutdown the output current. For PWM dimming, an external open-collector NPN transistor or open-drain N-channel MOSFET can be used to drive the ADJ pin. The PWM frequency can be low, around 100Hz to 1kHz, or high between 10kHz to 50kHz. C3 should not be fitted on the evaluation board when using the PWM dimming feature. Shorting R1 will connect the test pin ADJ to device pin ADJ. The capacitor C3 should be around 10nF to decouple high frequency noise at the ADJ pin for DC dimming.

The soft-start time will be nominally 0.5ms without capacitor C3. Adding C3 will increase the soft start time by approximately 0.5ms/nF

For other reference designs or further applications information, please refer to the ZXLD1350 datasheet.

Schematic Diagram

Figure 2 shows the schematic for the ZXLD1350EV7 evaluation board.

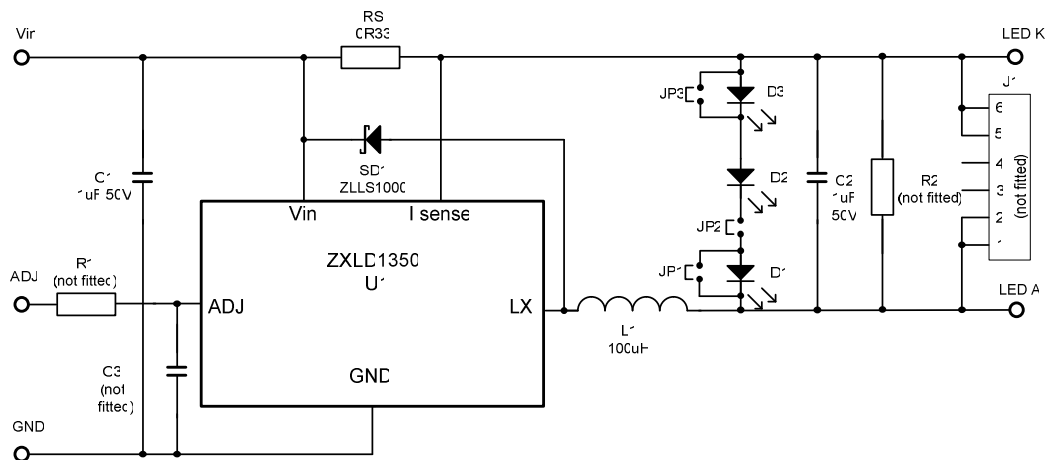

Figure 2: Schematic for the evaluation board ZXLD1350EV7

ZXLD1350 Operation

In normal operation, when voltage is applied at +VIN, the ZXLD13350 internal NDMOS switch is turned on. Current starts to flow through sense resistor Rs, inductor L1, and the LEDs. The current ramps up linearly, and the ramp rate is determined by the input voltage +VIN and the inductor L1. This rising current produces a voltage ramp across Rs. The internal circuit of the ZXLD1350 senses the voltage across Rs and applies a proportional voltage to the input of the internal comparator. When this voltage reaches an internally set upper threshold, the NDMOS switch is turned off. The inductor current continues to flow through Rs, L1, the LEDs, the schottky diode SD1, and back to the supply rail, but it decays, with the rate of decay determined by the forward voltage drop of the LEDs and the schottky diode. This decaying current produces a falling voltage at Rs, which is sensed by the ZXLD1350. A voltage proportional to the sense voltage across Rs is applied at the input of the internal comparator. When this voltage falls to the internally set lower threshold, the NDMOS switch is turned on again. This switch-on-and-off cycle continues to provide the average LED current set by the sense resistor Rs. Please refer to the datasheets for the threshold limits, ZXLD1350 internal circuits, electrical characteristics and parameters.

ZXLD1350EV7



ZXLD1350EV7 Evaluation Board.

Parts list

Please note that component part numbers are given as a guide only. Due to continual component development, all parts quoted should be checked for suitability and availability with their respective manufacturers.

Ref	Value	Package	Part Number	Manufacturer	Notes
Rs	0.33R 1%,200ppm	0805	NCST10FR330FTRF	NIC components	
R1,R2	Not fitted	0805			Not fitted
C1,C2	1uF, 50V, X7R	1206	C1206C105K5RAC7800 GRM31MR71H105KA88K NMC1206X7R105K50F	Kemet Murata NIC components	
C3	Not fitted	0805			Not fitted
L1	100uH		MSS6132-104MLB NPIS53D101MTRF	Coilcraft NIC components	
SD1	40V, 1.16A	SOT23	ZLLS1000	Zetex	Schottky diode
U1	ZXLD1350	TSOT23-5	ZXLD1350E5TA	Zetex	DC-DC converter
D1, D2, D3	1W LED		LXHL-PW01	Lumileds	White LED
JP1, JP2, JP3	Jumper			Various	2.54mm pitch jumper pin strips
+VIN, GND, ADJ, LED a, LED k	Test loop		100-108	Hughes	
J1	6 way connector				Not fitted

The 'slugs' of the 1-watt LEDs are connected to isolated copper 'floods' both on the top and bottom layers, with thermal inter-connection between the layers. The 'slugs' are electrically isolated from other circuits and pads on the evaluation board. **Warning: At a nominal 24V operation with 300mA output, the board temperature rises by around 30C from ambient after 30 minutes of operation.**

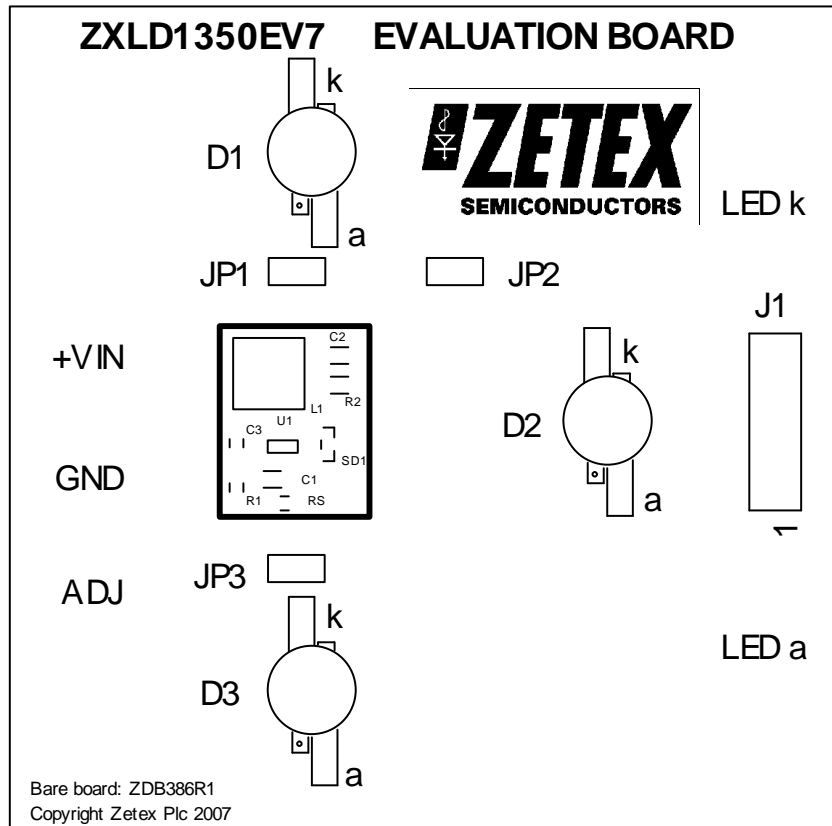

Figure 3: Component layout

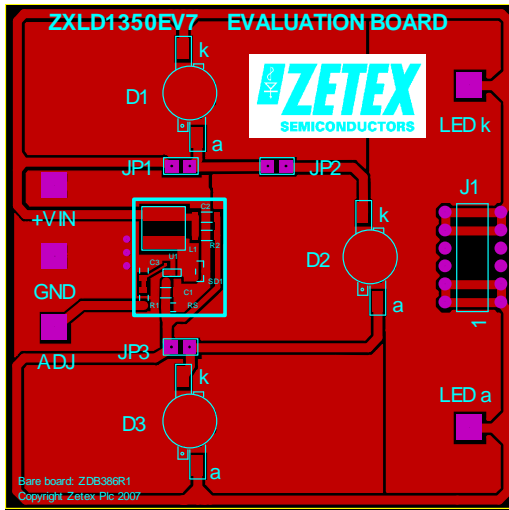

Figure 4: Top View

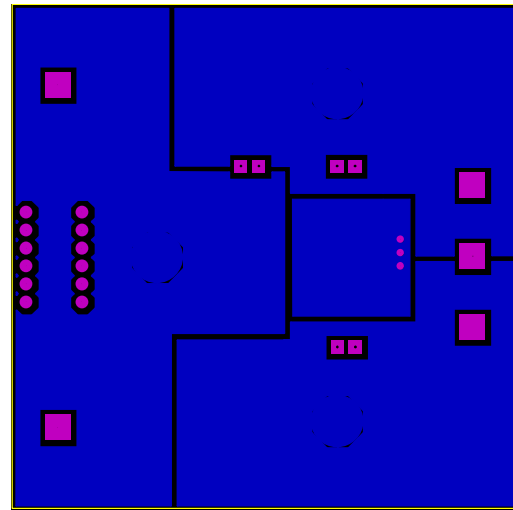

Figure 5: Bottom View

ZXLD1350EV7 Connection Point Definition	
Name	Description
+VIN	Positive supply voltage. Connect a +24V positive supply to this pin.
GND	Supply Ground (0V). Connect supply ground to this pin.
ADJ	Internal voltage ref. pin (1.25). This pin can be used to achieve dimming and soft-start, and for switching the output current off. <ul style="list-style-type: none"> • Leave floating for normal operation. • See 'Other Features' section to achieve dimming, and soft-start and for switching the output current off.
LED a	LED a connects to the ANODE of LED D3, and is the external LED anode connection point. Disconnect the jumper JP2 when driving an external load.
LED k	LED k connects to the CATHODE of LED D1, and is the external LED cathode connection point. Disconnect the jumper JP2 when driving external LEDs.
J1	Pins 1 & 2: LED a, Pins 5 & 6: LED k

ZXDL1350EV2 OPERATION

ZXLD1350EV7 Power Up

1. Connect VIN to +24V of the power supply unit (PSU). Connect GND to the power supply ground (0V).
Warning: The board does not feature reverse battery/supply protection.
2. Set the PSU to +24V. (+24V at VIN pin with ref. to the GND pin.)
3. Turn on the PSU.
Warning: Do not stare at the LEDs directly.
4. Ensure jumper J2 is fitted. With JP1 and JP3 disconnected (jumper off), all three LEDs should illuminate and will be regulated nominally at 300mA.
5. To change the number of LEDs connected in series, use jumper JP1 and JP3 to bypass LEDs D1 and D3 respectively.
Warning: The LEDs may be hot.

OTHER FEATURES

Dimming

The ZXLD1350 provides three dimming options: DC, high-frequency PWM, and low-frequency PWM dimming.

DC Voltage Dimming

1. Switch off the power supply.
2. Solder a link across R1 pads.
3. Fit a 10nF capacitor at C3 to decouple the pin.
4. Drive the ADJ pin on the board with a DC voltage in the range 0.3V to 1.25V.
5. Do not exceed 1.25V, as this represents 100% of the LED current set by Rs. The current will increase in proportion to this voltage. For example, if 2.5V is applied, the current will increase to 200%. That is, the current will be twice the 1.25V rating. For such over-drive of the ADJ pin, the LED and ZXLD1350 are likely to be damaged. The nominal LED current (output current), I_{OUT} , is given by

$$I_{OUT} = 0.08 * V_{ADJ}/R_s \quad \text{where} \quad \begin{array}{l} I_{OUT} = \text{the nominal LED current.} \\ V_{ADJ} = \text{the DC dimming voltage at ADJ pin resistor.} \\ 0.08 \text{ is the multiplier for the reference voltage on ADJ pin.} \\ R_s = \text{the sense resistor value in ohms.} \end{array}$$

Do not use a resistor value lower than 0.27Ω.

6. The dimming ratio is around 6:1. Note: as the voltage approaches 0.2V on the ADJ pin, the ZXLD1350 will shut down.
7. Follow the 'ZXLD1350EV7 Power Up' sequence.

High Frequency PWM Dimming

1. Switch off the power supply.
2. Solder a link across R1 pads.
3. Ensure C3 is not fitted.
4. Connect a PWM signal to the ADJ pin via an open collector NPN transistor, or an open drain N-channel MOSFET.
5. Alternatively, drive the ADJ pin directly with a PWM signal. However, make sure the PWM signal voltage levels do not violate the ADJ pin voltage rating. Driving the ADJ pin above 1.25V will exceed the maximum set current for the value of Rs and may damage the device or LED.
6. Set the PWM frequency to between 10KHz and 50KHz. The cut-off frequency of the internal filter is 4kHz, and exceeding the 50kHz may cause modulation with the switching regulator.
7. The dimming ratio will be about 6:1, similar to the DC dimming. The nominal LED current (output current), I_{OUT} , is given by

$$I_{OUT} = 0.1 * D/R_s \quad \text{where} \quad \begin{array}{l} I_{OUT} = \text{the nominal LED current.} \\ R_s = \text{the sense resistor value in ohms.} \\ \text{Do not use a resistor value lower than 0.27}\Omega. \\ D = \text{the duty cycle of the PWM dimming frequency.} \\ 0.1V \text{ is the nominal sense voltage with ADJ open circuit or set to 1.25V.} \end{array}$$

Note: The ADJ pin is internally referenced to 1.25V. This pin should be left floating for normal operation without dimming. Please refer to the datasheet for PWM frequency.

8. Follow the 'ZXLD1350EV7 Power Up' sequence.

Low Frequency PWM Dimming

1. Switch off the power supply.
2. Solder a link across R1 pads.
3. Make sure C3 is not fitted.
4. Connect a PWM signal to the ADJ pin via an open collector NPN transistor or an open drain N-channel MOSFET.
5. Alternatively, drive the ADJ pin directly with a PWM signal. However, make sure the PWM signal voltage levels do not violate the ADJ pin voltage rating. Driving the ADJ pin above 1.25V will exceed the maximum set current for the value of Rs and may damage the device or LED
6. The PWM frequency can be low; around 100Hz or up to 1kHz.
7. The ZXLD1350 is now effectively being turned on and off at the PWM frequency. The dimming ratios are in the region of 100:1, much greater than the DC dimming ratio. The average I LED current (output current), I_{OUT} , is given by

$$I_{OUT} = 0.1 \cdot D / R_s \quad \text{where} \quad \begin{array}{l} I_{OUT} = \text{the average LED current.} \\ R_s = \text{the sense resistor value in ohms.} \\ \text{Do not use a resistor value lower than } 0.27\Omega. \\ D = \text{the duty cycle of the PWM dimming frequency.} \\ 0.1V \text{ is the nominal sense voltage with ADJ open circuit or set to } 1.25V. \end{array}$$

8. Follow the 'ZXLD1350EV7 Power Up' sequence.

Soft-start

1. Switch off the power supply.
2. Solder a link across R1 pads.
3. Fit a capacitor at C3 to decouple the pin. The value of C3 will determine the soft-start time setting. Please see the datasheet for calculation of the capacitor value.
4. Follow the 'ZXLD1350EV7 Power Up' sequence.

Switching the output current off

1. Switch off the power supply.
2. Solder a link across R1 pads.
3. Follow the 'ZXLD1350EV7 Power Up' sequence.
4. Connect the ADJ pin to GND to turn off the output current.
5. Follow the 'ZXLD1350EV7 Power Up' sequence. The ZXLD1350 internal switch remains switched off (output current off) whilst the ADJ pin is pulled to GND.

Changing the LED current

1. Switch off the power supply.
2. Remove Rs.
3. Calculate and fit a new sense resistor, Rs, the value of which is based on the required LED current without dimming. Rs can be calculated using following equation :

$$R_s = 0.1V / I_{OUT} \quad \text{where} \quad \begin{array}{l} I_{OUT} = \text{the LED current.} \\ R_s = \text{the sense resistor value in ohms.} \\ \text{Do not use a resistor value lower than } 0.27\Omega. \\ 0.1V \text{ is the nominal sense voltage with ADJ open circuit or set to } 1.25V. \end{array}$$

4. Follow the 'ZXLD1350EV7 Power Up' sequence.

Using external LEDs or loads

1. Switch off the power supply.
2. Connect external LEDs across test pins 'LED a' and 'LED k'. 'LED a' is the LEDs' anode connection point and 'LED k' is the LEDs' cathode connection point. The number of external LEDs that can be connected depends on their operating power and forward voltage drop. For an external load other than LEDs, the positive terminal of the load should be connected to test pin 'LED a' and the negative terminal of the load should be connected to test pin 'LED k'. Connector J1 is compatible with the 'Luxeon® Emitter Board System' from Future Electronics, or can be used to connect LEDs via pin-strip connectors.
3. Follow the 'ZXLD1350EV7 Power Up' sequence.

ZXLD1350EV7



PERFORMANCE

The system efficiency depends on the sense resistor, supply voltage, switching inductor and the number of 1W LEDs connected in series.

The graph below shows the efficiency with a 0.33Ω sense resistor R_s , and a 100uH inductor, for 1 to 3 series connected 1W LEDs.

With a 24V supply, the switching frequency is typically 545kHz for three series-connected 1-watt LEDs and 300kHz for a single 1-watt LED.

With a 12V supply, the switching frequency is typically 160kHz for three series-connected 1-watt LEDs and 280kHz for a single 1-watt LED.

The detailed performance information for the device can be found in the datasheets.

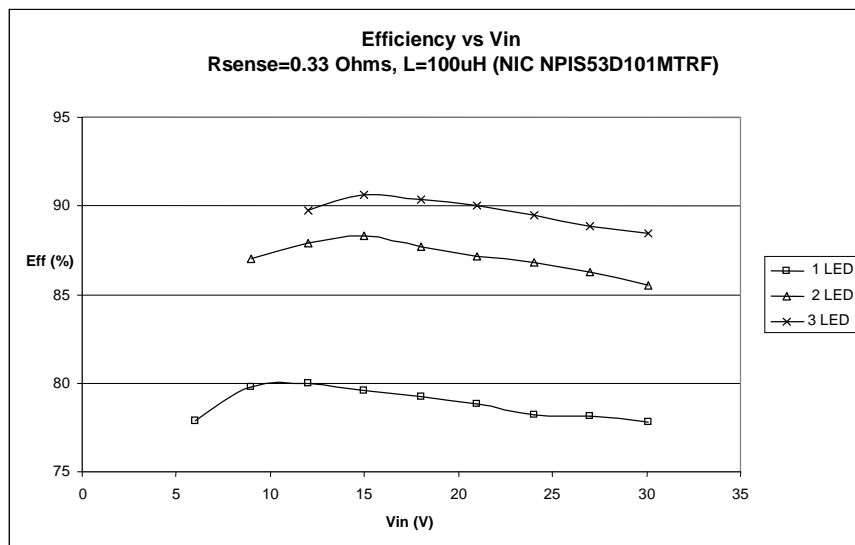

Figure 6: Efficiency vs supply voltage

Definitions

Product change

Zetex Semiconductors reserves the right to alter, without notice, specifications, design, price or conditions of supply of any product or service. Customers are solely responsible for obtaining the latest relevant information before placing orders.

Applications disclaimer

The circuits in this design/application note are offered as design ideas. It is the responsibility of the user to ensure that the circuit is fit for the user's application and meets with the user's requirements. No representation or warranty is given and no liability whatsoever is assumed by Zetex with respect to the accuracy or use of such information, or infringement of patents or other intellectual property rights arising from such use or otherwise. Zetex does not assume any legal responsibility or will not be held legally liable (whether in contract, tort (including negligence), breach of statutory duty, restriction or otherwise) for any damages, loss of profit, business, contract, opportunity or consequential loss in the use of these circuit applications, under any circumstances.

Life support

Zetex products are specifically not authorized for use as critical components in life support devices or systems without the express written approval of the Chief Executive Officer of Zetex Semiconductors plc. As used herein:

- A. Life support devices or systems are devices or systems which:
 1. are intended to implant into the body
 - or
 2. support or sustain life and whose failure to perform when properly used in accordance with instructions for use provided in the labeling can be reasonably expected to result in significant injury to the user.
- B. A critical component is any component in a life support device or system whose failure to perform can be reasonably expected to cause the failure of the life support device or to affect its safety or effectiveness.

Reproduction

The product specifications contained in this publication are issued to provide outline information only which (unless agreed by the company in writing) may not be used, applied or reproduced for any purpose or form part of any order or contract or be regarded as a representation relating to the products or services concerned.

Terms and Conditions

All products are sold subjects to Zetex' terms and conditions of sale, and this disclaimer (save in the event of a conflict between the two when the terms of the contract shall prevail) according to region, supplied at the time of order acknowledgement. For the latest information on technology, delivery terms and conditions and prices, please contact your nearest Zetex sales office.

Quality of product

Zetex is an ISO 9001 and TS16949 certified semiconductor manufacturer. To ensure quality of service and products we strongly advise the purchase of parts directly from Zetex Semiconductors or one of our regionally authorized distributors. For a complete listing of authorized distributors please visit: www.zetex.com/salesnetwork Zetex Semiconductors does not warrant or accept any liability whatsoever in respect of any parts purchased through unauthorized sales channels.

ESD (Electrostatic discharge)

Semiconductor devices are susceptible to damage by ESD. Suitable precautions should be taken when handling and transporting devices. The possible damage to devices depends on the circumstances of the handling and transporting, and the nature of the device. The extent of damage can vary from immediate functional or parametric malfunction to degradation of function or performance in use over time. Devices suspected of being affected should be replaced.

Green compliance

Zetex Semiconductors is committed to environmental excellence in all aspects of its operations which includes meeting or exceeding regulatory requirements with respect to the use of hazardous substances. Numerous successful programs have been implemented to reduce the use of hazardous substances and/or emissions. All Zetex components are compliant with the RoHS directive, and through this it is supporting its customers in their compliance with WEEE and ELV directives.

Product status key:

"Preview"	Future device intended for production at some point. Samples may be available
"Active"	Product status recommended for new designs
"Last time buy (LTB)"	Device will be discontinued and last time buy period and delivery is in effect
"Not recommended for new designs"	Device is still in production to support existing designs and production
"Obsolete"	Production has been discontinued

Datasheet status key:

"Draft version"	This term denotes a very early datasheet version and contains highly provisional information, which may change in any manner without notice.
"Provisional version"	This term denotes a pre-release datasheet. It provides a clear indication of anticipated performance. However, changes to the test conditions and specifications may occur, at any time and without notice.
"Issue"	This term denotes an issued datasheet containing finalized specifications. However, changes to specifications may occur, at any time and without notice.

Europe	Americas	Asia Pacific	Corporate Headquarters
Zetex GmbH Kustermann-park Balanstraße 59 D-81541 München Germany Telephone: (49) 89 45 49 49 0 Fax: (49) 89 45 49 49 49 europe.sales@zetex.com	Zetex Inc 700 Veterans Memorial Highway Hauppauge, NY 11788 USA Telephone: (1) 631 360 2222 Fax: (1) 631 360 8222 usa.sales@zetex.com	Zetex (Asia Ltd) 3701-04 Metroplaza Tower 1 Hing Fong Road, Kwai Fong Hong Kong Telephone: (852) 26100 611 Fax: (852) 24250 494 asia.sales@zetex.com	Zetex Semiconductors plc Zetex Technology Park, Chadderton Oldham, OL9 9LL United Kingdom Telephone (44) 161 622 4444 Fax: (44) 161 622 4446 hq@zetex.com