

Table of Content

Chapter1 Induction	2	4.2.1 Input EMI Filtering.....	6
1.1 General Description.....	2	4.2.2 Control IC.....	6
1.2 AP3917B Key Features.....	2	4.2.3 Flyback block.....	6
1.3 Applications.....	2	4.2.4 Output Rectification	6
1.4 Board Picture.....	2	4.2.5 Output Feedback	6
Chapter2 Power Supply Specification.....	3	4.3 Quick Start Guide.....	6
2.1 system performance.....	3	Chapter5. System test.....	7
2.2 Environment	3	5.1 Input & Output Characteristics	7
Chapter3 Schematic and bill of material	4	5.1.1 Input Standby Power	7
3.1 Schematic.....	4	5.1.2 Efficiency.....	7
3.2 Bill of Material.....	4	5.1.3 Line Regulation.....	8
3.3 Transformer Specification	5	5.1.4 load regulation	9
3.3.1 Electrical Diagram.....	5	5.2 Key Performance test.....	9
3.3.2 Transformer Instructions.....	5	5.2.1 Start up performance	9
3.3.3 Electrical Specifications	5	5.2.2 Voltage Stress.....	10
Chapter4 Evaluation Board Connections	5	5.2.3 Output Ripple & Noise	11
4.1 PCB Layout	5	5.2.4 Dynamic Response.....	12
4.2 Circuit Description	6	5.3 Protection(SCP) test	13
		5.4 Thermal Test	14
		5.5 System EMI Scan.....	15
		5.5.1 Conduction EMI test of 230V@full load	15
		5.5.2 Conduction EMI test of 110V@full load	16

Chapter1 Induction

1.1 General Description

AP3917B is an off-line universal AC Voltage input step-down regulator that provides accurate constant voltage (CV), outstanding low standby power, light loading efficiency and dynamics performance. The chip supports non-isolated buck and buck-boost topology, and also isolated and non-isolated flyback topology. The main applications are for cost-effective home appliance power.

Working with a single winding inductor and integrating a 650V MOSFET when used in buck topology, the BOM cost is very low.

The AP3917B EV3 Evaluation Board contains two outputs specifications: 12V20mA and 3.8V20mA, with both non-isolated flyback. The two outputs share a three-winding transformer. The feedback circuitry samples 3.8V output. The user's guide provides good design example for dual output power applications in home appliance power.

1.2 AP3917B Key Features

- Universal 85V to 264V V_{AC} Input
- Internal MOSFET 650V ($R_{ds(on)}$ 10 Ω max. @25°C)
- Maximum output Current: 170mA typ. @5V output
- Low Standby Power Consumption
- High Light Loading Efficiency and average efficiency can meet DOE IV and CoC V5 Tier 2
- Frequency Modulation to suppress EMI to meet EN55032 and FCC part 15 class B
- Rich Protection including: OTP, OLP, OLD, SCP
- Extremely low system component count.
- Totally Lead-free & Fully RoHS Compliant (SO-7)
- Halogen and Antimony Free. "Green" Device

1.3 Applications

- Non-Isolated Home Appliances including: AC Fans, Rice Cooker, Air conditioner, Coffee Machines, Soy Milk Machines, ect.
- Auxiliary Power to IoT Devices.

1.4 Board Picture

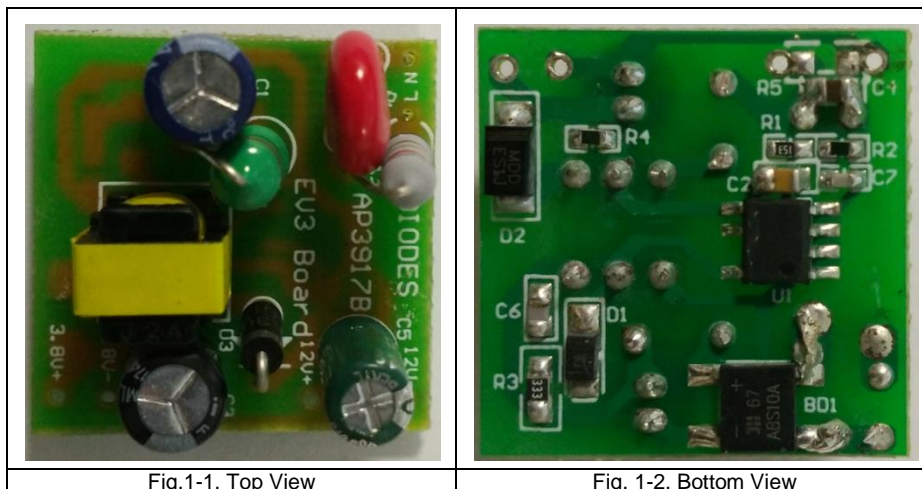

Fig.1-1, Top View

Fig. 1-2, Bottom View

Chapter2 Power Supply Specification

2.1 system performance

The system performance included in and output characters, specifications, EMC, protection, ect.

Items	Min.	Typ.	Max.	Comments
input characters				
Input AC voltage rating	100V/60Hz	115/230	240V/50Hz	Two wire, no PE
Input AC voltage range	85V/60Hz	-	264V/50Hz	
Input AC frequency range	47Hz	50/60	63Hz	
Output characters				
Output voltage 1	11.1V	12.0V	12.9V	Test at board terminal
Output voltage 1	3.61V	3.8V	3.99V	
loading current 1	0	-	20mA	mA
loading current 2	4	-	20mA	
performance specifications				
Standby power	-		12mW	@230V/50Hz
Efficiency	-	74.32%/72.98%	-	@full load, 115V/230V
Ripple & Noise	12V	-	192mV	@full load
	3.8V	-	101mV	
Start up time	-	16.8ms	20ms	@full load, 85V/60Hz
EMC test				
ESD test	Air	±15kV	-	@full load condition
	contract	±8kV	-	
Surge Test		±0.5kV	-	Differential mode, 2ohm, 1.2/50us
Conduction EMI	110V	6dB margin	-	FCC Part 15 Class B
	230V	6dB margin	-	EN55032
Protection function				
SCP test	-	-	-	OK
OLP test	-	-	-	OK
OTP test	135°C	150°C	165°C	OK

2.2 Environment

Operation temperature: -20°C~85°C

Operation Humidity: 20%~90% R.H.

Storage temperature: 0~40°C

Storage Humidity: 0%~95% R.H.

Chapter3 Schematic and bill of material

3.1 Schematic

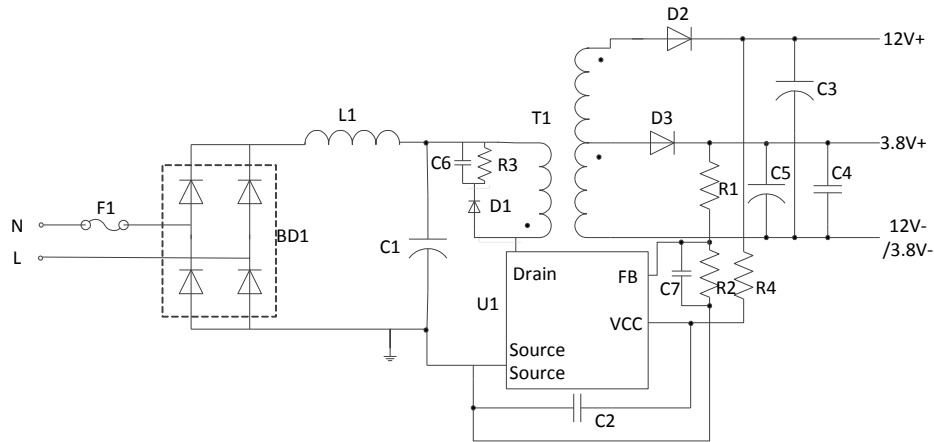

Fig. 3-1, Evaluation Board Schematic

3.2 Bill of Material

Table 3-1, bill of material

Item	Designator	Description	Footprint	Qty.	Manufacturer
1	F1	8.2R, fusible resistor	Φ3*10mm	1	OAHE
2	BD1	ABS10A, bridge diode	SOPA-4	1	Diodes
3	C1	2.2uF/400V, electrolytic capacitor	Φ6*9mm	1	Aishi
4	C2	2.2uF/25V, X7R	SMD 0805	1	Telesky
5	C3	100uF/16V, electrolytic capacitor	Φ6*7mm	1	Aishi
6	C4	10uF/16V, X7R	SMD 0805	1	Telesky
7	C5	22uF/16V, electrolytic capacitor	Φ5*10mm	1	Telesky
8	C6	470pF/500V, X7R	SMD 0805	1	Telesky
9	C7	470pF/50V, X7R	SMD 0805	1	Telesky
10	D1	S1MWF-7, slow type diode, mark F9	SOD123-FL	1	Diodes
11	D2	ES1J, 1A/600V, Trr 35ns	SMA	1	Diodes
12	D3	APD260, Schottky diode, 2A/60V	DO-41	1	Diodes
13	L1	2.2mH,choke inductor	DIP, 0406	1	Deloop
14	T1	EE8.3, Horizontal	DIP, 3+3Pin, Horizontal	1	Deloop
15	R1	24.7k, thick film	SMD 0805, 1%	1	Panasonic
16	R2	13.0k, thick film	SMD 0805, 1%	1	Panasonic
17	R3	330k, thick film	SMD 0805, 5%	1	Panasonic
18	R4	27k, thick film	SMD 0805, 5%	1	Panasonic
19	U1	AP3917B	SO-7	1	Diodes
total		19pcs			

3.3 Transformer Specification

3.3.1 Electrical Diagram

Bobbin: EE8.3, 3+3Pin, Horizontal
 Core: PC40, Ae=7mm²

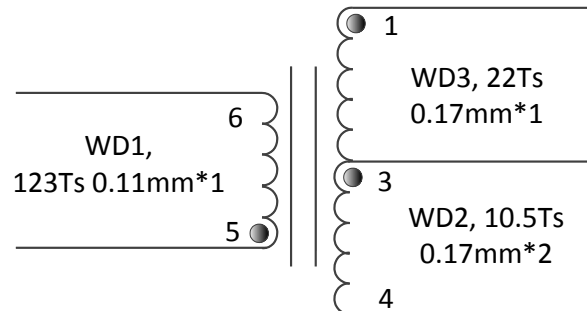

Fig. 3-2, transformer electrical diagram

3.3.2 Transformer Instructions

Winding	Wire	Turns	Notes
5-6	0.11mm*1 UEW	123	three layer with tight tension
Tape	W=5mm	2	Full layer
3-4	0.17mm*2 UEW	10.5	One layer with tight tension
Tape	W=5mm	2	Full layer
1-3	0.17mm*1 UEW	23	One layer with tight tension
Tape	W=7mm	2	Full layer

Note: the transformer need be varnished. Put the transformer in the varnish for 30min, then remove it to the oven at 90°C for at least 6 hours.

3.3.3 Electrical Specifications

Item	Pins	Inductance	Conditions
Main inductance	5-6	800uH±7%	1/3/4pin open, 1V/10kHz
Leak inductance	5-6	<50uH	1/3/4pin short, 1V/10kHz

Chapter4 Evaluation Board Connections

4.1 PCB Layout

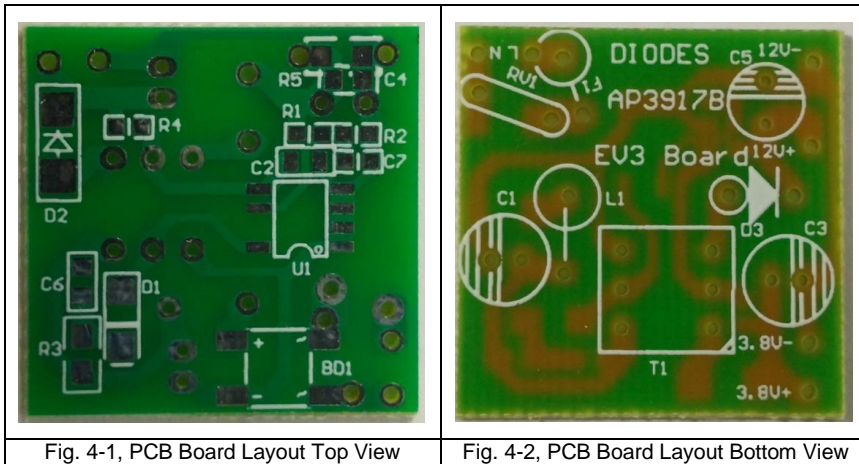

Fig. 4-1, PCB Board Layout Top View

Fig. 4-2, PCB Board Layout Bottom View

4.2 Circuit Description

4.2.1 Input EMI Filtering

The input stage is composed of fusible resistor RF1, bridge diodes (BD1), Capacitors C1 and inductor L1. Resistor RF1 is a flame proof, fusible, wire-wound resistor. It limits inrush current to safe levels for bridge diodes, provides differential mode noise reduction and acts as an input fuse in the event of short circuit. Inductor L1 and Capacitor C1 constitute a LC filter, which can smooth the input voltage and improve EMI conduction.

4.2.2 Control IC

AP3917B co-packages a 650V power MOSFET and control circuitry into a cost-effective SO-8 package. The device gets its start-up current from DRAIN pin with a small capacitor C3 connect to BP pin when AC source is applied.

4.2.3 Flyback block

The flyback system which coupled in a transformer contains two output, 12V and 3.8V. The 3.8V output winding and 12V output winding are in series, so if the turn ratio of 12V winding to 3.8V winding approximate to 12/3.8, the output voltage can be fixed to 12V and 3.8V.

4.2.4 Output Rectification

During the ON time of U1, current ramps in the main inductance of transformer T1 until the current reaches to the I_{pk} . During the OFF time the inductor current ramps down via diodes D2 and D3. D2 and D3 must be ultra-fast diode or schottky diode ($T_{rr} < 50ns$ or lower). Capacitor C3/C5 should be selected to have an adequate ripple margin.

4.2.5 Output Feedback

The voltage across C4/C5 is quite smooth, so the divider R1 and R2 can reflect the output voltage. The output voltage dividend by R1 and R2 was sent to feedback pin to regulate the 3.8V output voltage, thus regulate the 12V output voltage. A small capacitor C7 about several hundreds of pF was used to prevent sharp noise of sampling circuit.

4.3 Quick Start Guide

1. The evaluation board is preset at 12V/20mA+3.8V20mA from output.
2. Ensure that the AC source is switched OFF or disconnected before doing connection.
3. Connect the AC line wires of power supply to "L and N" on the left side of the board.
4. Turn on the AC main switch.
5. Measure output terminals to ensure correct output voltages of Vo1 and Vo2 respectively.

Chapter5. System test

5.1 Input & Output Characteristics

5.1.1 Input Standby Power

The standby power and output voltage was tested after 10min burning. The voltage data was tested at the PCB terminal. All the data was tested at room temperature.

Table 5-1, standby power and no load output voltage

Input Voltage	Pin (mW)	Vo1 (V)	Vo2 (V)
85V/60Hz	5.0	3.791	12.202
115V/60Hz	5.4	3.791	12.205
230V/50Hz	7.8	3.788	12.197
264V/50Hz	8.6	3.788	12.197

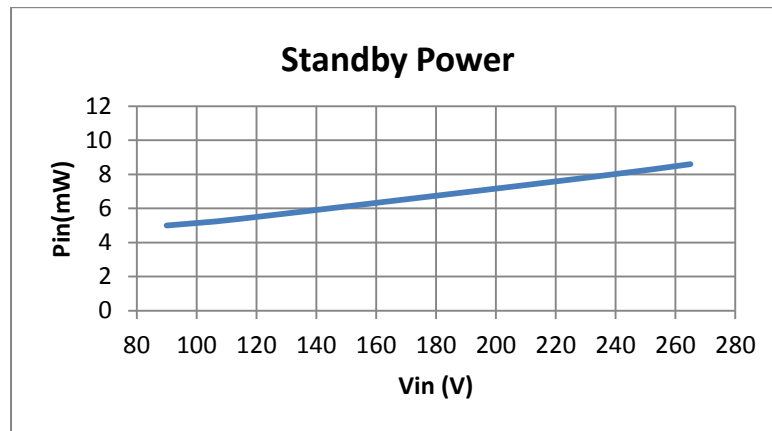

Fig. 5-1, Standby Power versus Vin Curve

5.1.2 Efficiency

The efficiency data was tested after 10min burning, and it was tested at the PCB terminal. All the data was tested at room temperature. 12V and 3.8V full load, input voltage range from 85V/60Hz to 265V/50Hz.

Table 5-2, Full load efficiency VS Vin data

Vin	Vo1(V)	Vo2(V)	Pin(W)	Eff.
85V/60Hz	3.752	12.291	0.451	73.22%
115V/60Hz	3.746	12.280	0.452	72.98%
150V/60Hz	3.749	12.282	0.444	74.32%
180V/50Hz	3.748	12.280	0.446	73.97%
200V/50Hz	3.748	12.280	0.447	73.80%
230V/50Hz	3.746	12.280	0.452	72.98%
265V/50Hz	3.746	12.278	0.460	71.70%

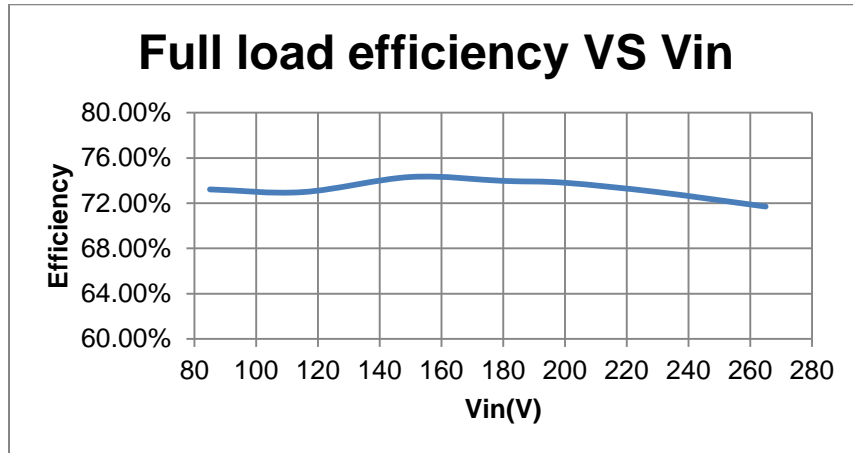

Fig. 5-2, Full load efficiency VS Vin

5.1.3 Line Regulation

The line regulation data was tested after 10min burning. The voltage data was tested at the PCB terminal. All the data was tested at room temperature. 3.8V and 12V full load, Vin ranges from 85V to 264V.

Table 5-3, line and load regulation data

Vin	Vo1 output(V)	Vo2 output (V)
Vin	Vo1(V)	Vo2(V)
85V/60Hz	3.752	12.291
115V/60Hz	3.746	12.280
150V/60Hz	3.749	12.282
180V/50Hz	3.748	12.280
200V/50Hz	3.748	12.280
230V/50Hz	3.746	12.280
265V/50Hz	3.746	12.278

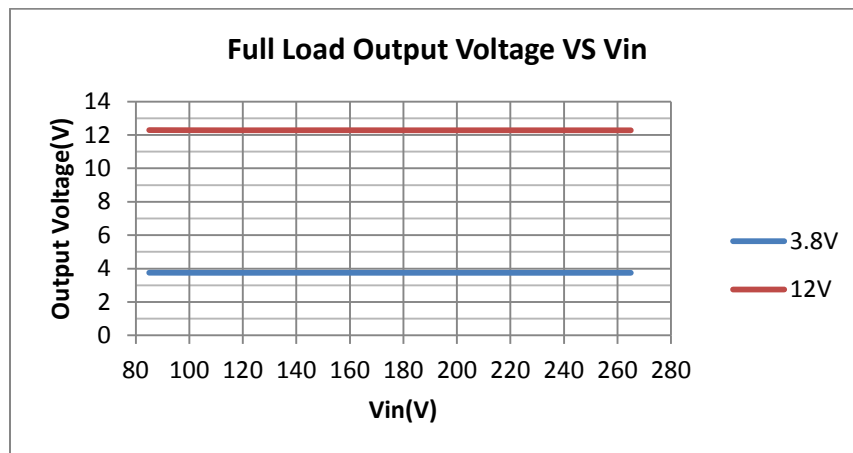

Fig 5-3, 3.8V and 12V full load, output voltage versus input voltage

5.1.4 Load Regulation

The load regulation data was tested after 10min burning. The voltage data was tested at the PCB terminal. All the data was tested at room temperature. The load of Vo1 and Vo2 terminals both ranges from 10% to 100%.

Table 5-4, Vo1 and Vo2 output voltage

Vin	10%		25%		50%		75%		100%	
	Vo1(V)	Vo2(V)	Vo1(V)	Vo2(V)	Vo1(V)	Vo2(V)	Vo1(V)	Vo2(V)	Vo1(V)	Vo2(V)
85V/60Hz	3.788	11.578	3.785	11.772	3.788	11.937	3.772	12.057	3.768	12.157
115V/60Hz	3.788	11.585	3.784	3.777	3.774	11.932	3.772	12.052	3.766	12.157
230V/50Hz	3.786	11.572	3.781	11.757	3.774	11.922	3.769	12.047	3.764	12.147
265V/50Hz	3.785	11.572	3.780	11.755	3.774	11.922	3.768	12.045	3.763	12.147

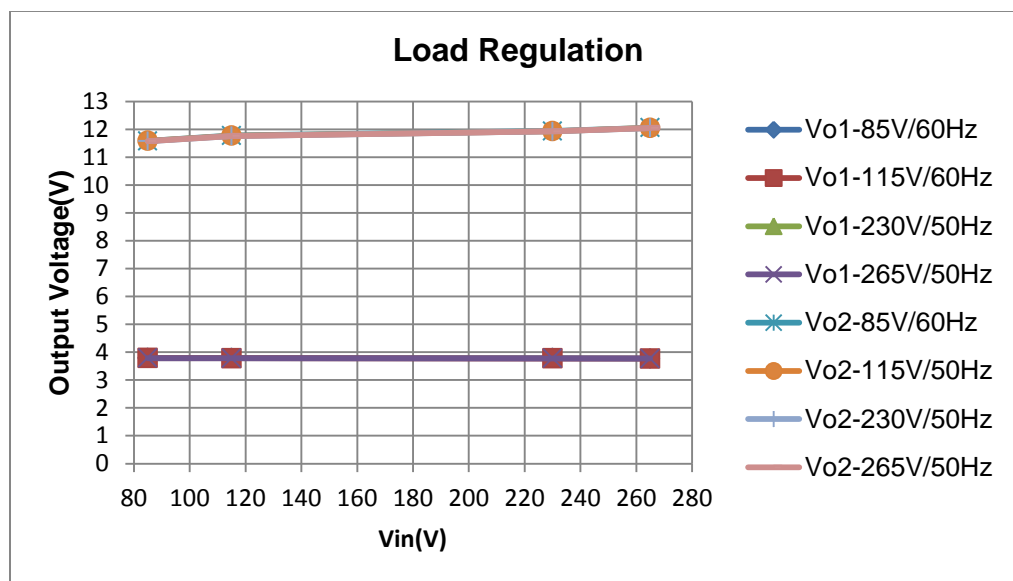

Fig. 5-4, 12V and 5V output voltage@ 3.8V no load

5.2 Key Performance test

5.2.1 Start up performance

The start-up time was measured with differential probe clipping on the input AC source, and the common low-voltage probe clipping on the output terminal. Before start-up, the buck cap should be discharged.

Table 5-5, start up performance

Input voltage	Start up time	figures
85V/60Hz	16.8ms	Fig. 15
115V/50Hz	16.1ms	Fig. 16
230V/50Hz	15.3ms	Fig. 17
264V/60Hz	14.6ms	Fig. 18

Turn on Waveforms

CH1: Vin; CH2: 3.8V output; CH3:12V output

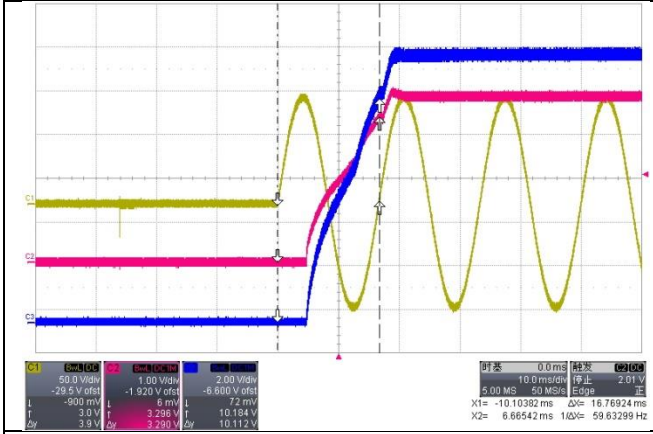

Fig. 5-5, Start up time is 16.8ms @full load, 85V/60Hz

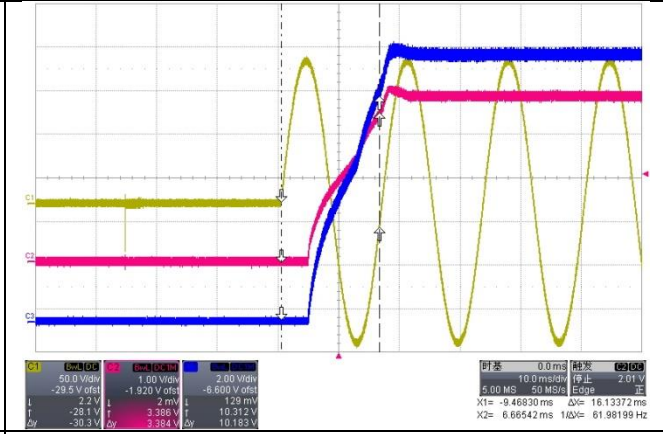

Fig 5-6, Start up time is 16.1ms @full load, 115V/60Hz

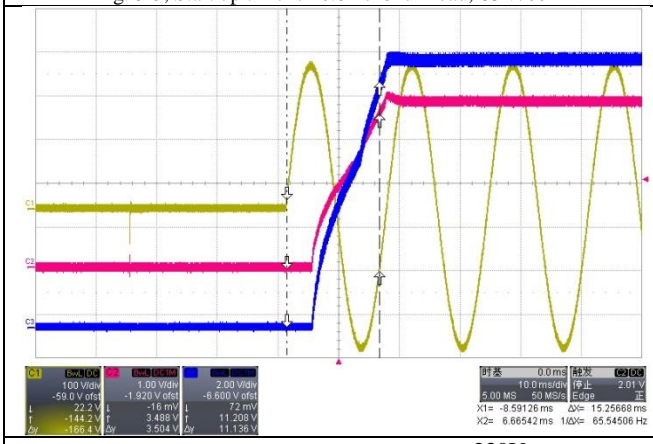

Fig. 5-7, Start up time is 15.3ms @full load, 230V/50Hz

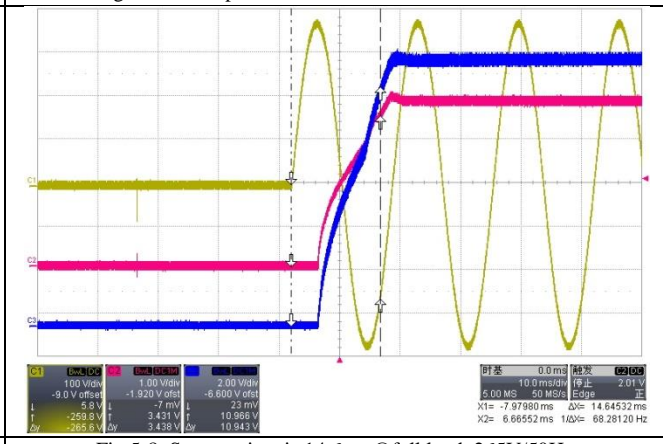

Fig 5-8, Start up time is 14.6ms @full load, 265V/50Hz

5.2.2 Voltage Stress

The voltage tested below was between the source and the drain pin of IC. The test need use differential probe. The Vak voltage is tested between the anode and cathode of flyback diodes D2/D3.

Table 5-6, MOSFET drain-source and flyback diodes Vak voltage stress

Input voltage	Voltage stress			figures
	Vds(V)	Vak1(V)	Vak2(V)	
85V/60Hz	221	17	57	Fig. 19
115V/50Hz	265	21	65	-
230V/50Hz	429	37	119	-
264V/60Hz	484	42	129	Fig. 22

CH1: Vds/Vak2; CH2: Vak1

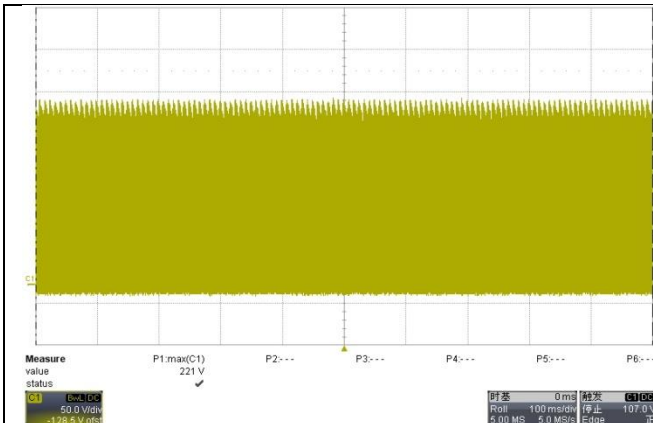

Fig. 5-9, MOS drain-source 221V@85V/60Hz, full load

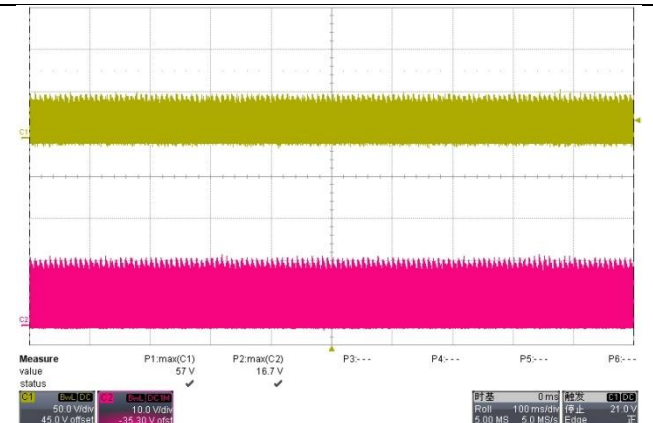

Fig. 5-10, Vo1 terminal Vak 17V, Vo2 Vak 57V@85V/60Hz, full load

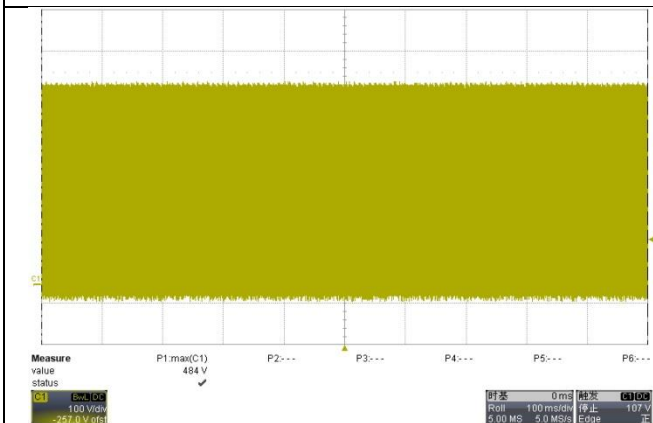

Fig. 5-11, MOS drain-source 484V @265V/50Hz, full load

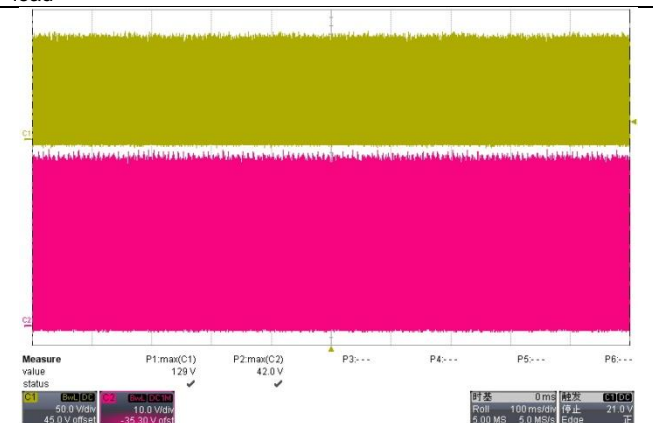

Fig. 5-12, Vo1 terminal Vak 129V, Vo2 Vak 42V@264V/50Hz, full load

5.2.3 Output Ripple & Noise

The ripple and noise was tested at PCB terminal, using coaxial cable (1:1). The bandwidth was limited to 20MHz. A 10uF electrolytic capacitor and a 104 ceramic capacitor should be paralleled to the output terminal.

Table 5-7, ripple & noise

Conditions	Input voltage	R&N(mV)		Figures
		Vo1 terminal	Vo2 terminal	
3.8V full load, 12V full load	85V/60Hz	96	184	Fig. 23
	115V/50Hz	96	184	-
	230V/50Hz	101	192	-
	264V/60Hz	101	190	Fig. 24

CH1:Vo1 output; CH4:Vo2 output

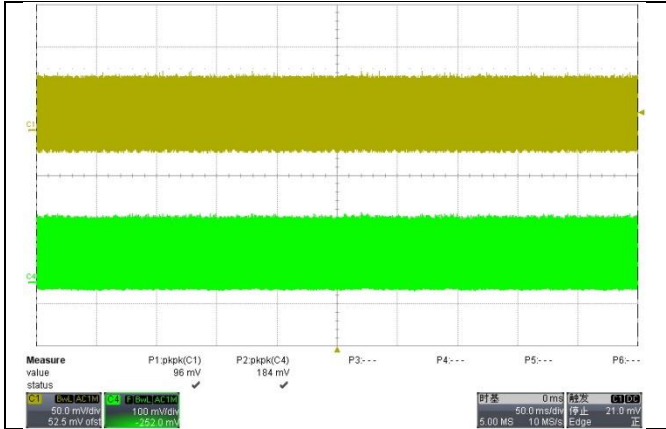

Fig.5-13, Output R&N 96/184mV@3.8V and 12V full load, 85V/60Hz

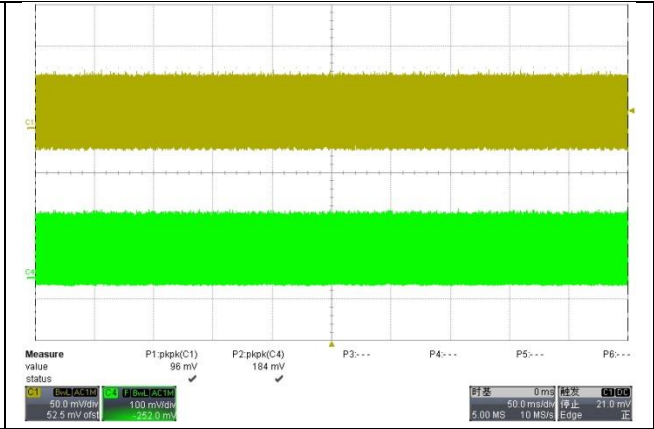

Fig.5-14, Output R&N 96/184mV@3.8V and 12V full load, 115V/60Hz

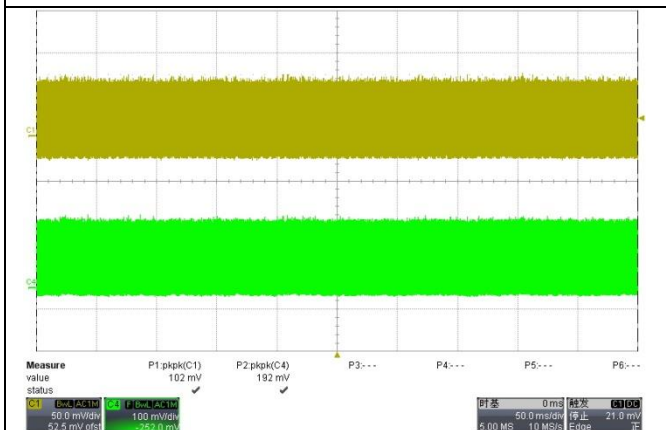

Fig.5-15, Output R&N101/192mV@3.8V and 12V full load, 230V/50Hz

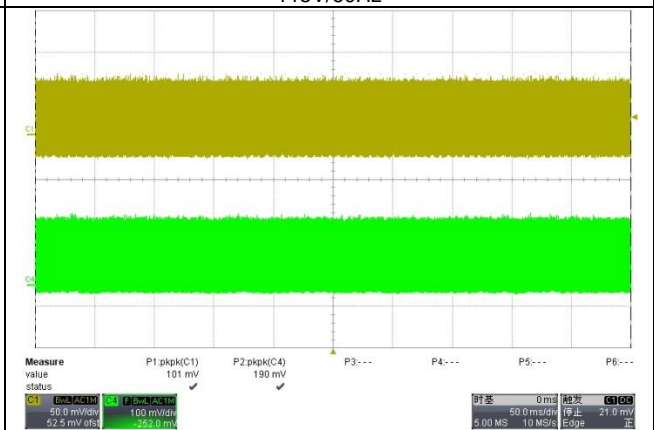

Fig.5-16, Output R&N 101/190mV@3.8V and 12V full load, 265V/50Hz

5.2.4 Dynamic Response

The dynamic response output voltage was tested at the PCB terminal, and the bandwidth was limited to 20MHz. The loading is set 0mA as low load and 20mA as high load, and last for 0.1s respectively. The ramp is set at 40mA/us.

Table 5-8, dynamic response

Conditions	Vin	Output voltage(V)				Figures
		Vo1		Vo2		
		Max (V)	Min (V)	Max (V)	Min (V)	
12V full load, 3.8V loading 0~100%	85V/60Hz	4.16	3.62	12.94	8.65	Fig. 27
	115V/60Hz	4.10	3.65	12.87	8.52	-
	230V/50Hz	4.06	3.65	12.87	8.71	-
	264V/50Hz	4.10	3.65	12.94	8.31	Fig. 28
3.8V full load, 12V loading 0~100%	85V/60Hz	3.98	3.63	15.01	12.00	Fig. 29
	115V/60Hz	3.95	3.63	15.01	11.94	-
	230V/50Hz	4.02	3.63	15.01	11.94	-
	264V/50Hz	4.02	3.63	15.07	11.94	Fig. 30

CH3:12V output; CH2:3.8V output

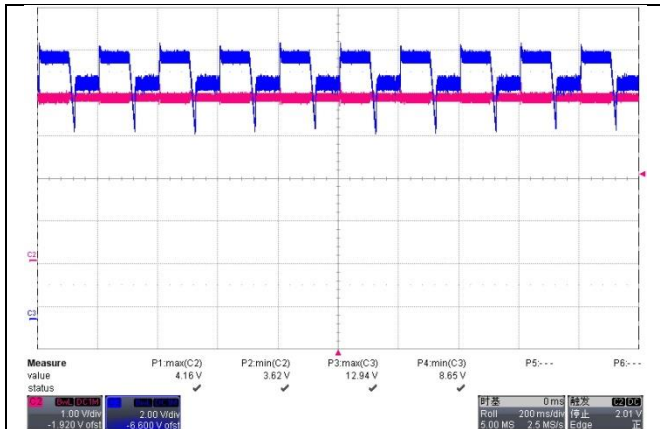

Fig.5-17 dynamic response@3.8V 0~20mA,12V FL, @85V/60Hz

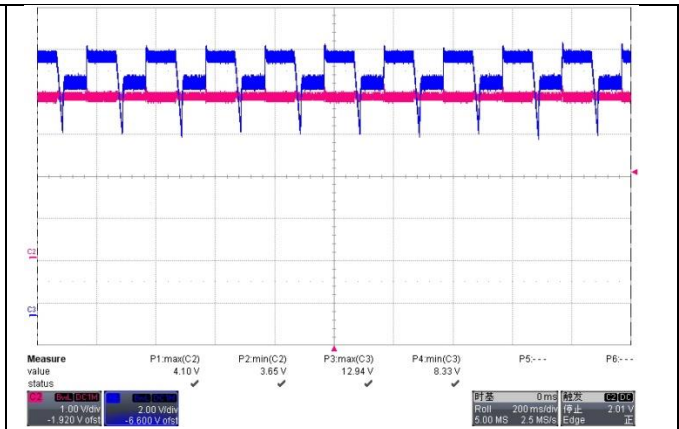

Fig. 5-18 dynamic response@3.8V 0~20mA,12V FL, @265V/50Hz

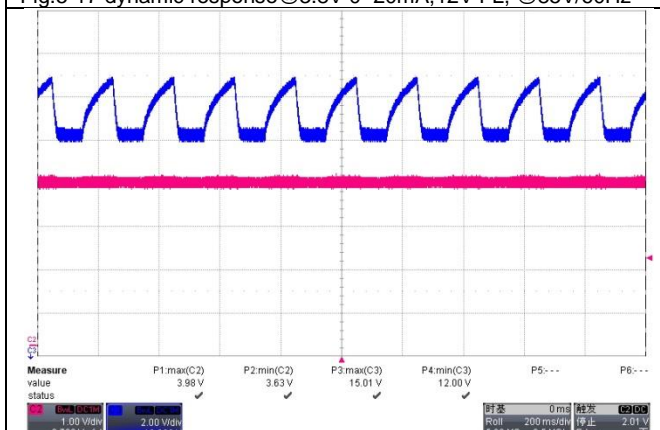

Fig.5-19, dynamic response@12V 0~20mA,3.8V FL, @85V/60Hz

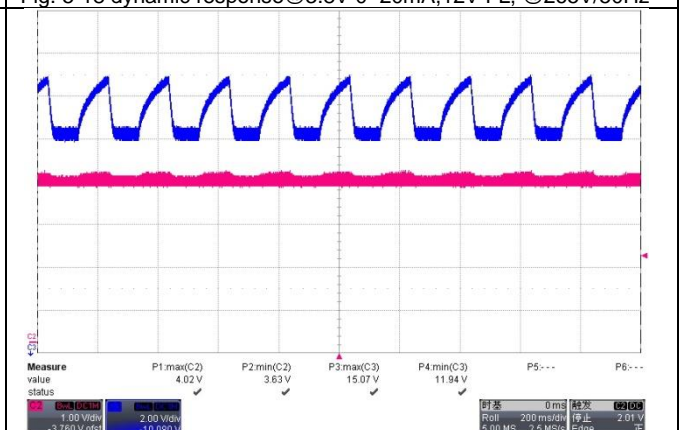

Fig. 5-20, dynamic response@12V 0~20mA,3.8V FL, @265V/50Hz

5.3 Protection (SCP) test

The SCP test was measured under the condition of output cable terminal short circuit.

Table 5-9, the short circuit protection test

Condition	Vin	Vo1 max(V)	Vo2 max(V)	Figures
12V terminal output short	85V/60Hz	0.416	0.508	Fig. 31
	115V/60Hz	0.425	0.512	-
	230V/50Hz	0.463	0.503	-
	264V/50Hz	0.480	0.508	Fig. 32
3.8V terminal output short	85V/60Hz	0.544	2.81	Fig. 33
	115V/60Hz	0.562	2.90	-
	230V/50Hz	0.588	3.05	-
	264V/50Hz	0.608	3.07	Fig. 34

CH2:3.8V output; CH3:12V output

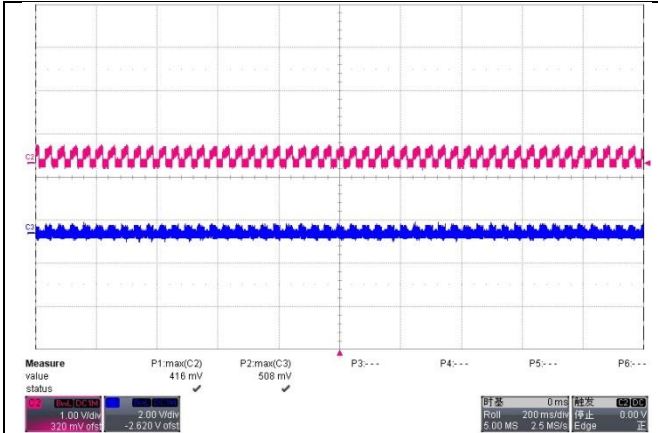

Fig. 5-21, SCP @12V output short and 3.8V full load, 85V/60Hz

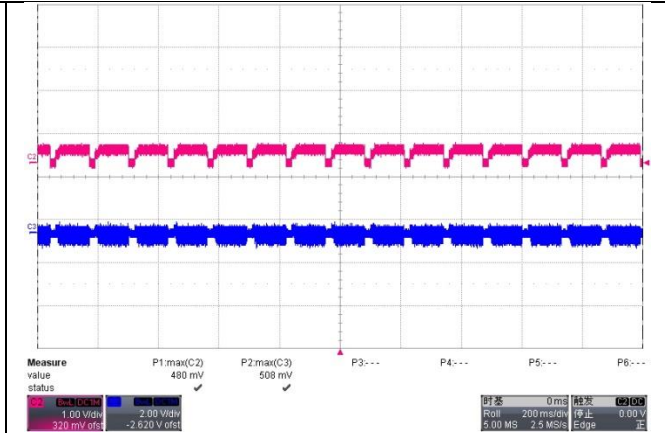

Fig. 5-22, SCP @12V output short and 3.8V full load, 265V/50Hz

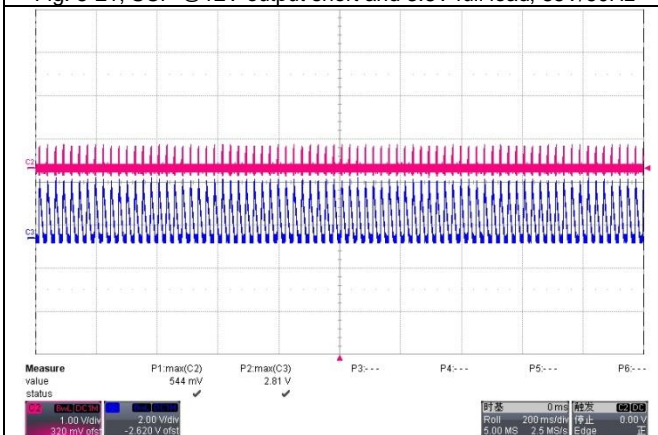

Fig. 5-23, SCP@12V output short and 3.8V full load, 85V/60Hz

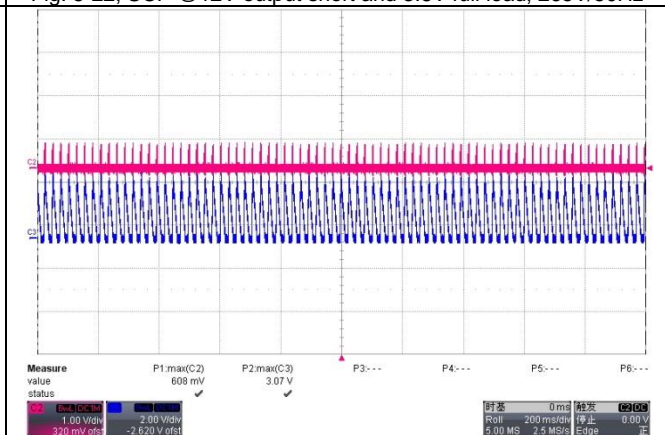

Fig. 5-24, SCP@12V output short and 3.8V full load, 265V/50Hz

5.4 Thermal Test

The thermal test was under room temperature after burning 1 hour. The board has no case, and using thermal imager to observe the surface temperature of IC.

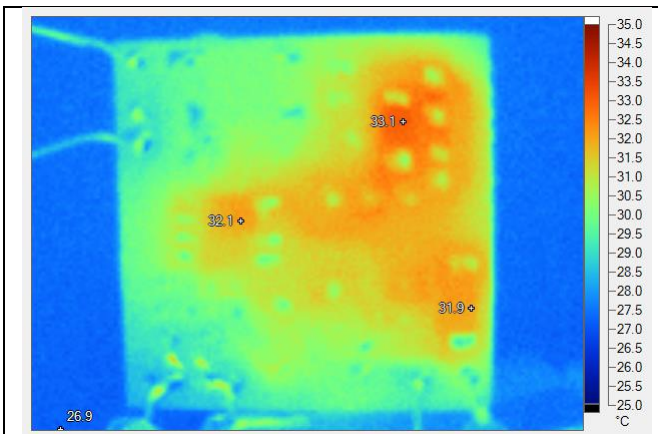

Fig. 5-25, IC 32.1°C, 12V flyback diode 31.9°C, RCD diode 33.1°C@full load, 85V/60Hz, ambient temperature 26.9°C.

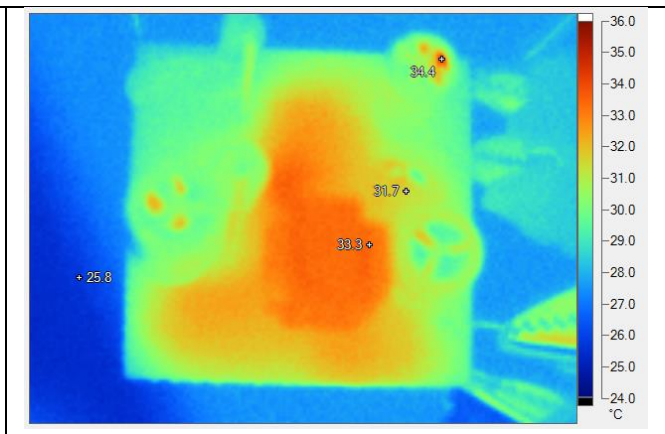

Fig. 5-26, Transformer 33.3°C, 3.8V flyback diode 31.7°C@full load, 264V/50Hz, ambient temperature 25.8°C.

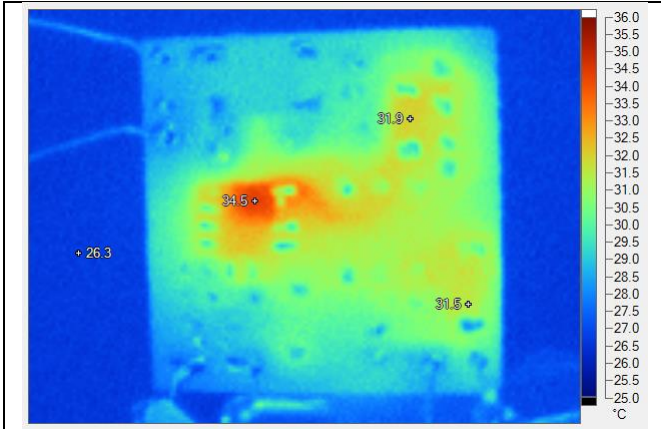

Fig. 5-27, IC 34.5°C, 12V flyback diode 31.5°C, RCD diode 31.9°C@full load, 265V/50Hz, ambient temperature 26.3°C.

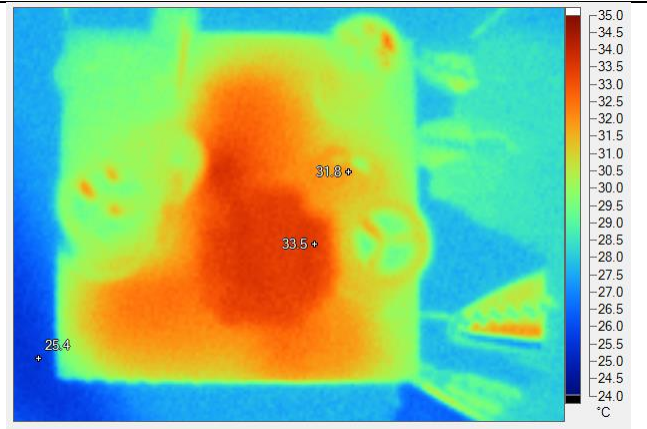

Fig. 5-28, Transformer 33.5°C, 3.8V flyback diode 31.8°C@full load, 264V/50Hz, ambient temperature 25.4°C.

5.5 System EMI Scan

The power supply passed EN55022 Class B (for 230V input) and FCC part 15 (for 110V input) EMI requirement with more than 6dB margin.

5.5.1 Conduction EMI test of 230V@full load

The test result can pass EN55022 Class B limitation with more than 6dB margin.

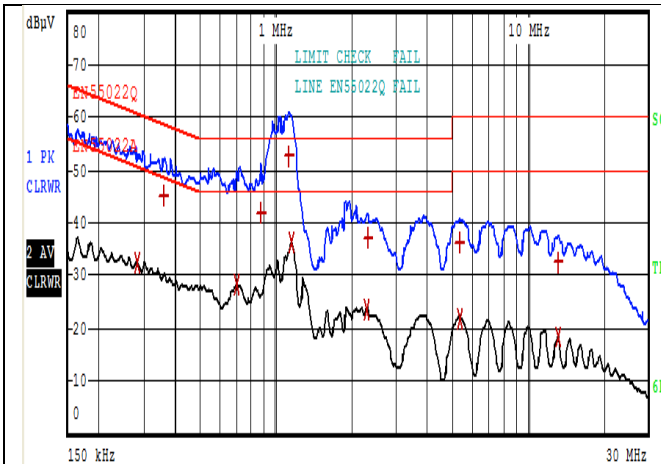

Fig. 5-29, L line conduction waveform@230V, full load.

EDIT PEAK LIST (Final Measurement Results)			
TRACE	FREQUENCY	LEVEL dBμV	DELTA LIMIT dB
Trace1: EN55022Q			
Trace2: EN55022A			
Trace3: ---			
2	Average	298.034163623 kHz	31.85
1	Quasi Peak	346.008411606 kHz	45.26
1	Quasi Peak	413.877088109 kHz	42.76
2	Average	495.058034186 kHz	28.95
1	Quasi Peak	1.13065507631 MHz	47.41
2	Average	1.27405044044 MHz	33.95
1	Quasi Peak	2.29164676133 MHz	35.82
2	Average	2.29164676133 MHz	22.64
1	Quasi Peak	5.28619370567 MHz	34.67
2	Average	5.33905564273 MHz	20.39
1	Quasi Peak	13.0733860985 MHz	31.45
2	Average	13.0733860985 MHz	17.42

Fig. 5-30, L line conduction data@230V, full load.

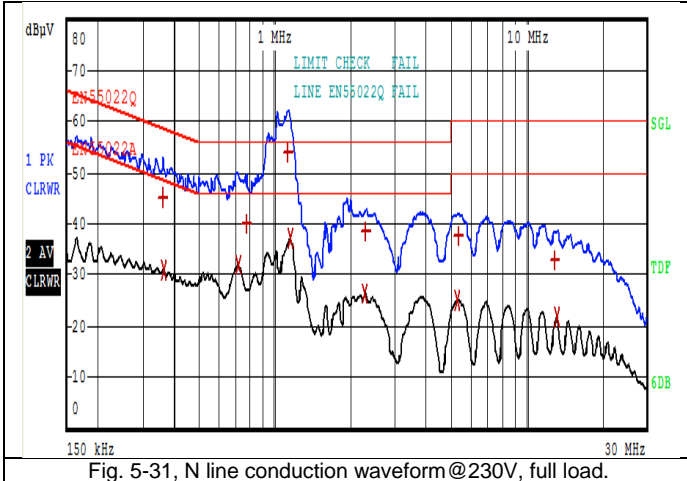

Fig. 5-31, N line conduction waveform@230V, full load.

EDIT PEAK LIST (Final Measurement Results)			
TRACE	FREQUENCY	LEVEL dBμV	DELTA LIMIT dB
Trace1:	EN55022Q		
Trace2:	EN55022A		
Trace3:	---		
1 Quasi Peak	259.278686021 kHz	49.14	-12.30
2 Average	356.492812486 kHz	31.05	-17.75
1 Quasi Peak	541.437681113 kHz	39.90	-16.09
2 Average	708.31358138 kHz	29.66	-16.33
1 Quasi Peak	1.1194604716 MHz	49.21	-6.78
2 Average	1.27405044044 MHz	34.67	-11.32
1 Quasi Peak	2.29164676133 MHz	37.63	-18.36
2 Average	2.29164676133 MHz	25.37	-20.62
2 Average	5.28619370567 MHz	24.26	-25.73
1 Quasi Peak	5.44637066114 MHz	36.07	-23.92
1 Quasi Peak	12.9439466322 MHz	32.81	-27.18
2 Average	13.0733860985 MHz	20.99	-29.00

Fig. 5-32, N line conduction data@230V, full load.

5.5.2 Conduction EMI test of 110V@full load

The test result can pass FCC part 15 limitation with more than 6dB margin.

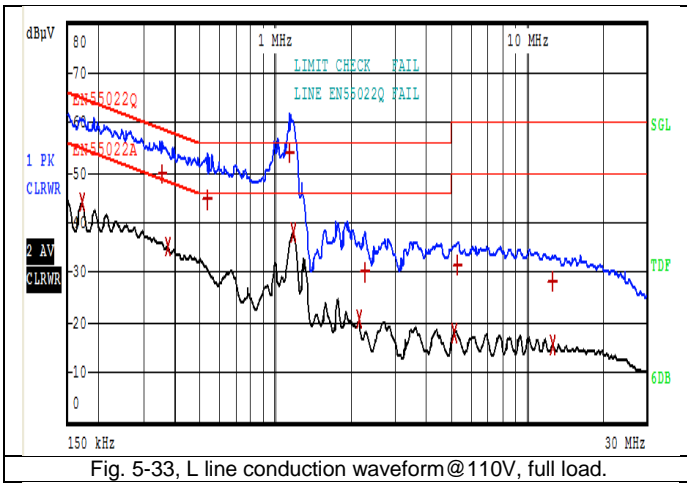

Fig. 5-33, L line conduction waveform@110V, full load.

EDIT PEAK LIST (Final Measurement Results)			
TRACE	FREQUENCY	LEVEL dBμV	DELTA LIMIT dB
Trace1:	EN55022Q		
Trace2:	EN55022A		
Trace3:	---		
2 Average	169.02375452 kHz	44.54	-10.46
1 Quasi Peak	322.728292586 kHz	52.28	-7.35
2 Average	374.677528711 kHz	36.25	-12.14
1 Quasi Peak	452.651275966 kHz	47.73	-9.09
1 Quasi Peak	1.03380296375 MHz	46.09	-9.90
2 Average	1.28679094484 MHz	33.81	-12.18
1 Quasi Peak	2.1374603093 MHz	31.90	-24.09
2 Average	2.1374603093 MHz	20.71	-25.28
2 Average	5.28619370567 MHz	17.54	-32.45
1 Quasi Peak	6.2646263072 MHz	30.20	-29.79
1 Quasi Peak	12.9439466322 MHz	27.84	-32.16
2 Average	12.9439466322 MHz	15.44	-34.55

Fig. 5-34, L line conduction data@110V, full load.

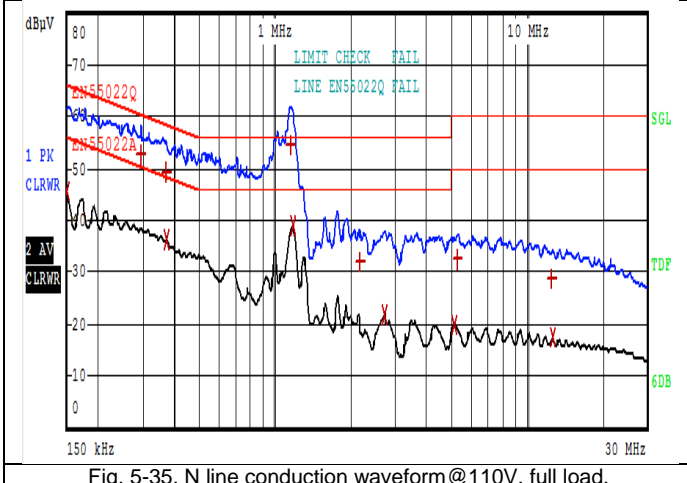

Fig. 5-35, N line conduction waveform@110V, full load.

EDIT PEAK LIST (Final Measurement Results)			
TRACE	FREQUENCY	LEVEL dBμV	DELTA LIMIT dB
Trace1:	EN55022Q		
Trace2:	EN55022A		
Trace3:	---		
2 Average	169.02375452 kHz	43.74	-11.26
1 Quasi Peak	289.269022958 kHz	52.70	-7.84
2 Average	370.967850209 kHz	36.13	-12.34
1 Quasi Peak	413.877088109 kHz	48.25	-9.31
1 Quasi Peak	1.02356729084 MHz	47.22	-8.77
2 Average	1.28679094484 MHz	34.10	-11.90
2 Average	2.1374603093 MHz	22.24	-23.75
1 Quasi Peak	2.1588349124 MHz	33.49	-22.50
2 Average	5.28619370567 MHz	19.44	-30.55
1 Quasi Peak	5.50083436776 MHz	31.41	-28.58
2 Average	12.9439466322 MHz	16.83	-33.16
1 Quasi Peak	13.0733860985 MHz	28.80	-31.19

Fig. 5-36, N line conduction data@110V, full load.

IMPORTANT NOTICE

DIODES INCORPORATED MAKES NO WARRANTY OF ANY KIND, EXPRESS OR IMPLIED, WITH REGARDS TO THIS DOCUMENT, INCLUDING, BUT NOT LIMITED TO, THE IMPLIED WARRANTIES OF MERCHANTABILITY AND FITNESS FOR A PARTICULAR PURPOSE (AND THEIR EQUIVALENTS UNDER THE LAWS OF ANY JURISDICTION).

Diodes Incorporated and its subsidiaries reserve the right to make modifications, enhancements, improvements, corrections or other changes without further notice to this document and any product described herein. Diodes Incorporated does not assume any liability arising out of the application or use of this document or any product described herein; neither does Diodes Incorporated convey any license under its patent or trademark rights, nor the rights of others. Any Customer or user of this document or products described herein in such applications shall assume all risks of such use and will agree to hold Diodes Incorporated and all the companies whose products are represented on Diodes Incorporated website, harmless against all damages.

Diodes Incorporated does not warrant or accept any liability whatsoever in respect of any products purchased through unauthorized sales channel.

Should Customers purchase or use Diodes Incorporated products for any unintended or unauthorized application, Customers shall indemnify and hold Diodes Incorporated and its representatives harmless against all claims, damages, expenses, and attorney fees arising out of, directly or indirectly, any claim of personal injury or death associated with such unintended or unauthorized application.

Products described herein may be covered by one or more United States, international or foreign patents pending. Product names and markings noted herein may also be covered by one or more United States, international or foreign trademarks.

This document is written in English but may be translated into multiple languages for reference. Only the English version of this document is the final and determinative format released by Diodes Incorporated.

LIFE SUPPORT

Diodes Incorporated products are specifically not authorized for use as critical components in life support devices or systems without the express written approval of the Chief Executive Officer of Diodes Incorporated. As used herein:

A. Life support devices or systems are devices or systems which:

1. are intended to implant into the body, or
2. support or sustain life and whose failure to perform when properly used in accordance with instructions for use provided in the labeling can be reasonably expected to result in significant injury to the user.

B. A critical component is any component in a life support device or system whose failure to perform can be reasonably expected to cause the failure of the life support device or to affect its safety or effectiveness.

Customers represent that they have all necessary expertise in the safety and regulatory ramifications of their life support devices or systems, and acknowledge and agree that they are solely responsible for all legal, regulatory and safety-related requirements concerning their products and any use of Diodes Incorporated products in such safety-critical, life support devices or systems, notwithstanding any devices- or systems-related information or support that may be provided by Diodes Incorporated. Further, Customers must fully indemnify Diodes Incorporated and its representatives against any damages arising out of the use of Diodes Incorporated products in such safety-critical, life support devices or systems.

Copyright © 2016, Diodes Incorporated

www.diodes.com