

## **Content:**

- 1. Description**
- 2. Specification**
- 3. Schematic of the Demo Board**
- 4. PCB Layout**
- 5. Photo View of the Demo Board**
- 6. PCB Dimensions**
- 7. BOM**
- 8. Test Result**

## Description

The AP3015 is a step-up DC/DC converter, which can be used for 1 or 2 cell powered system. In fact, it is a standard boost circuit, where the AP3015 works as the driver and control device.

The AP3015 features a wide input voltage range. The operation voltage is ranged from 1.2V to 12V. And the output voltage is up to 34V. A current limited, fixed off-time control scheme conserves operating current, resulting in high efficiency over a broad range of load current. The switch and all of the control circuit are integrated in the AP3015, so fewer tiny external components are needed in the PCB board, which are bypass capacitor ( $C_{in}$ ), boost inductor (L), boost schottky diode (D), output capacitor ( $C_{out}$ ), feedback resistor network ( $R1, R2$ ) and feedback capacitor ( $C_f$ ).

The demo board can be powered from 1.2V to 2.5V. The output voltage can be controlled by the feedback resistor network. The feedback reference is 1.23V, so the output voltage can be calculated as  $1.23 \cdot (R2 + R1) / R2$ . To achieve at flexible operation, a disable terminal is designed to turn on or turn off the demo board output.

## Specification

Item	Value
Supply Voltage	1.2 to 2.5V
Output Current (Max.)	40mA @ $V_{in}=1.2V$
	50mA @ $V_{in}=1.5V$
	80mA @ $V_{in}=2.5V$
Output Voltage	$3.3V \pm 5\%$
Ripple & Noise (Max.)	150mV
Efficiency (Typ.)	70% @ $V_{in}=1.2V, I_o=40mA$
	73% @ $V_{in}=1.5V, I_o=50mA$
	81% @ $V_{in}=2.5V, I_o=80mA$

Micro Power Step-Up DC/DC Converter AP3015

**Schematic of the Demo Board**

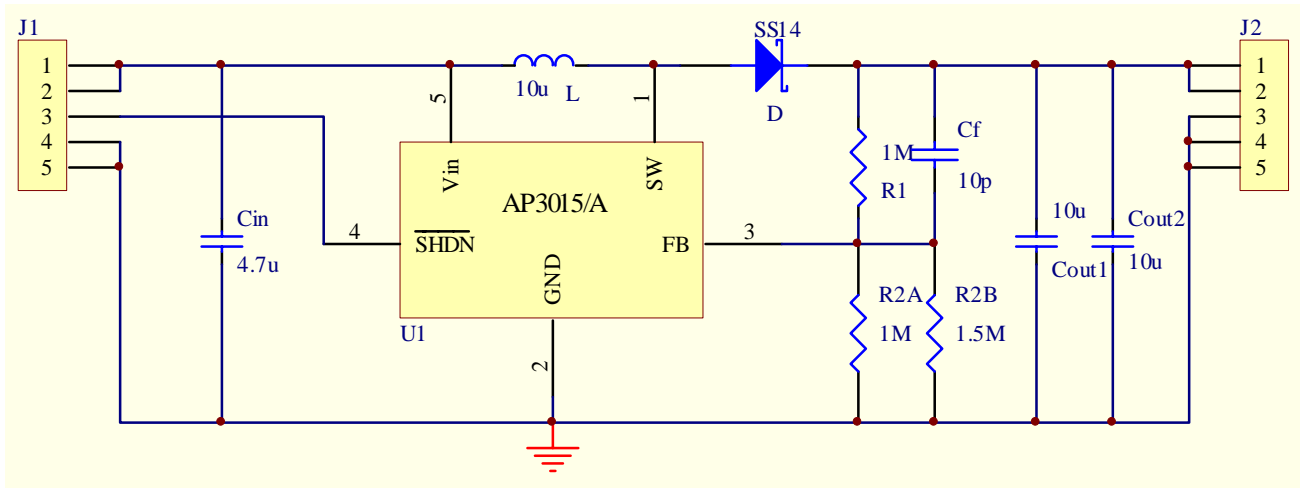

Note: Cout2 is backup.

Figure 1

**PCB Layout**

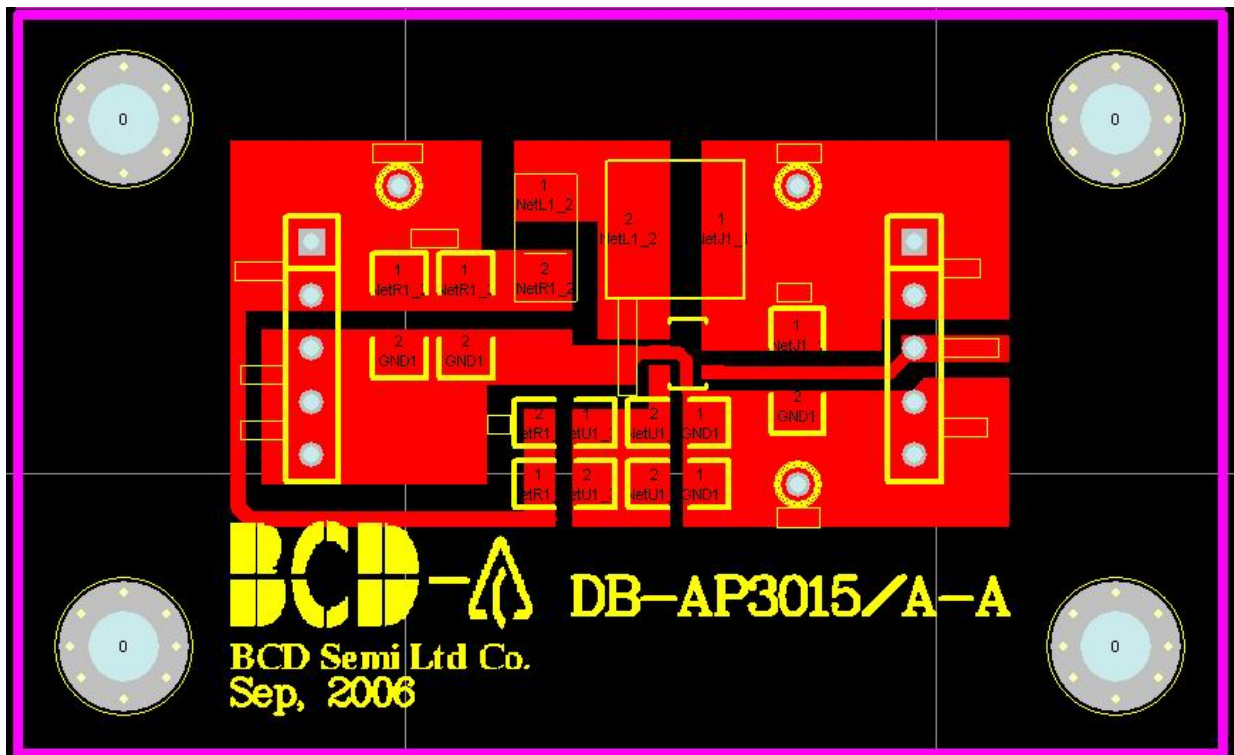

Figure 2

**Photo View of the Demo Board**



Figure 3

**PCB Dimensions**

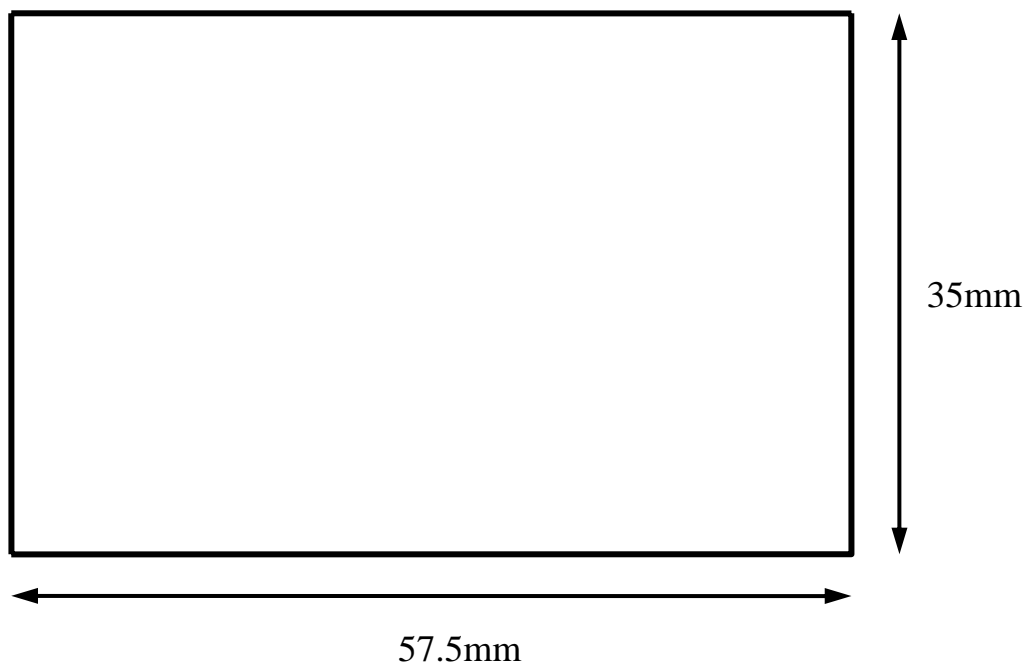

## Micro Power Step-Up DC/DC Converter

AP3015

**BOM**

Item	Quantity	Location	Part	Footprint
1	1	U1	AP3015	SOT23-5
2	1	L	10uF, Sumida: CDRH5D28RNP-100NC	SMD
3	1	Cin	4.7uF, X7R Ceramic	1206
4	1	Cout1	10uF, X7R Ceramic	1206
5	1	Cf	10pF, X7R Ceramic	0805
6	1	D	SS14, Schottky	SMD
7	1	R1	1M, 1%	0805
8	1	R2A	1M, 1%	0805
9	1	R2B	1.5M, 1%	0805
10	2	J1, J2	5 Pin Connector	SIP-5
11	1	Cout2	NC	

**Test Result**
**1) Output Voltage**

Vin	Vout @ Iout=0mA	Vout @ Io=40mA	Vout @ Io= 50mA	Vout @ Io= 100mA
1.2V	3.299V	3.185V	---	---
1.5V	3.302V	3.225	3.189V	---
2.5V	3.324V	3.302V	3.289V	3.218V

**2) Ripple & Noise**

Vin=1.2V, Iout=40mA

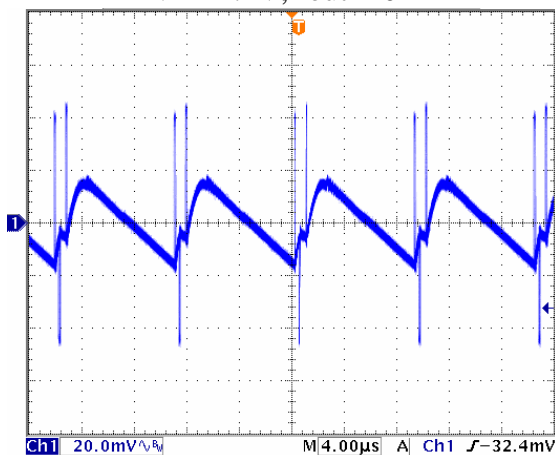

Vin=1.5V, Iout=50mA

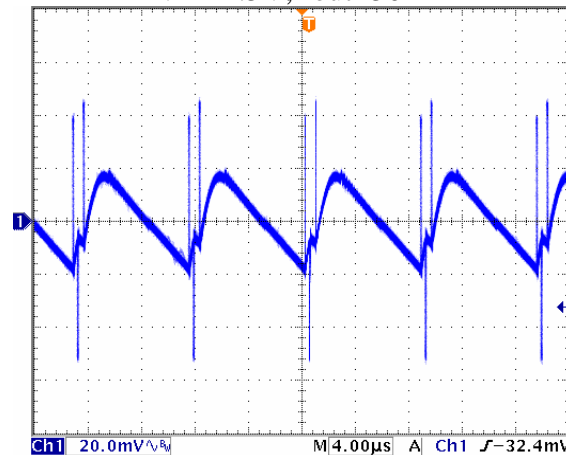

**Micro Power Step-Up DC/DC Converter** **AP3015**

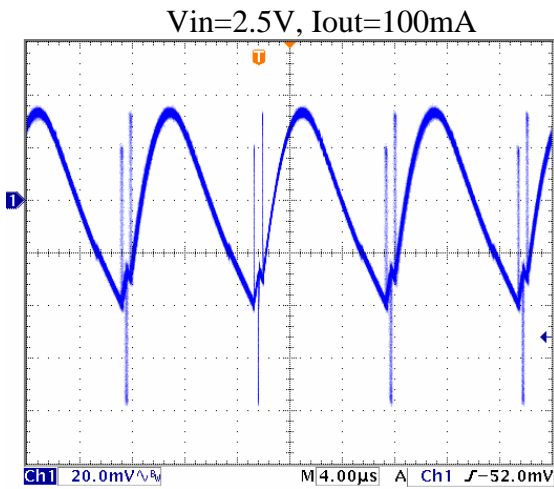

**3) Efficiency**

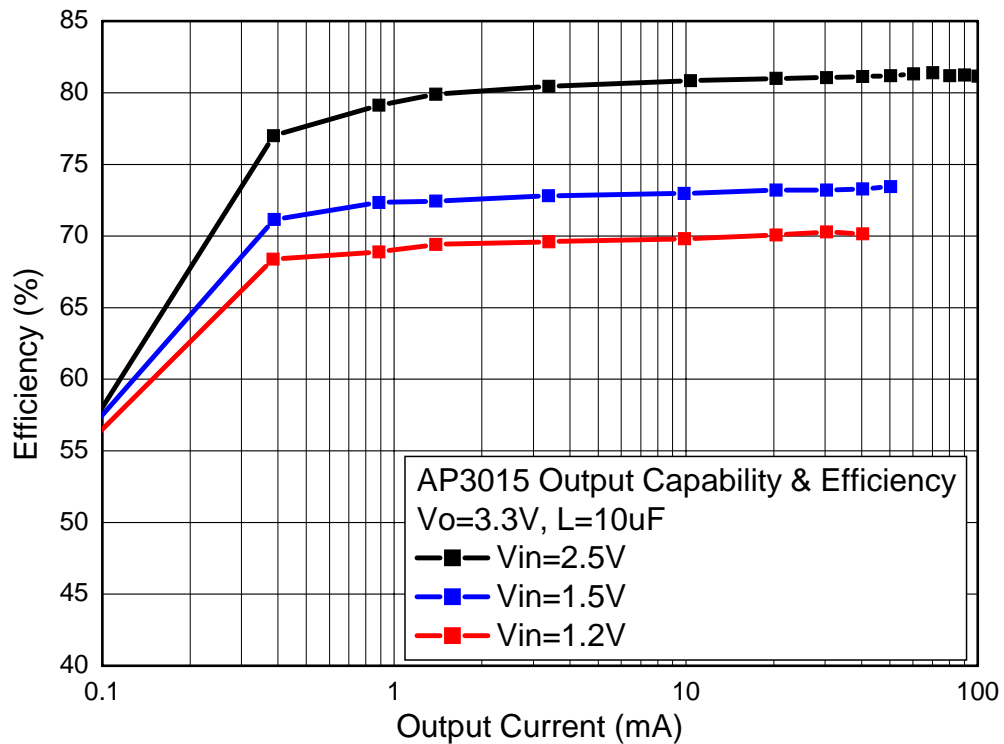

Note: The Max. Output Capability is 46mA @ Vin=1.2V, 55mA @ Vin=1.5V and 125mA @ Vin=2.5V. The recommended maximum Output Capability is 40mA @ Vin=1.2V, 50mA @ Vin=1.5V and 100mA @ Vin=2.5V.