

General Description

Based on flyback topology, the AP3125A EV1 board is designed to serve as an example for cost-effective power solutions suitable for IoT applications. Rated at 25W power output, AP3125A EV1 board accepts universal AC voltage input while delivers 12V@2A and 5V@0.2A for IoT main functions as well as for IoT connectivity. The AP3125A EV1 meets DOE VI and CoC Tier 2 energy efficiency requirement with standby power lower than 0.2W.

Key Features

- 90 ~265V_{AC} input range
- Current mode control & 65KHz operation switching frequency
- Over 85% Efficiency
- Very low standby input power <0.2W
- Low start-up operating and quiescent currents
- Soft start during startup process.
- Working at CCM mode when AC input is lower and at DCM mode when AC input is higher
- Frequency fold back for high average efficiency
- Built-in Jittering Frequency
- Soft Switching for Reducing EMI
- Internal Auto Recovery OCP, OVP, OLP, OTP Power Protection, cycle by cycle current limit, also with DC polarity protection

Applications

- Switching AC-DC Adaptor & Charger
- Power home Appliances
- Set-top box power supply
- Open frame switching power supply
- Gaming system

AP3125A universal AC input EV1 Specifications (CV mode)

Parameter	Value
Input Voltage	90 to 265V _{AC}
Input standby power	0.2 W
Main output Vo / Io	12V - 2A
Second output Vos/Ios	5V - 0.2A
Efficiency	>85%
Total Output Power	25W
Protections	OCV, OVP, OLP, OTP
XYZ Dimension	69 x 42 x 24 mm
ROHS Compliance	Yes

Evaluation Board

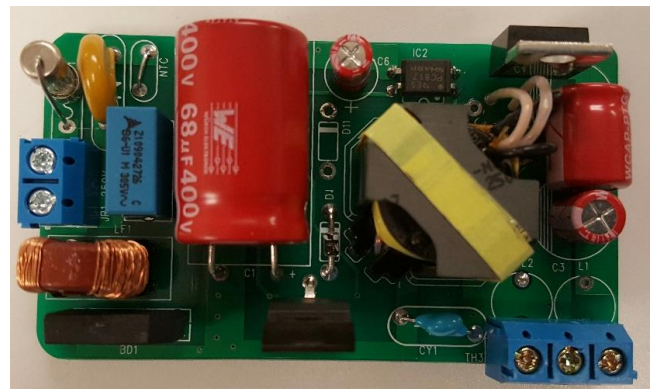

Figure 1: Top View

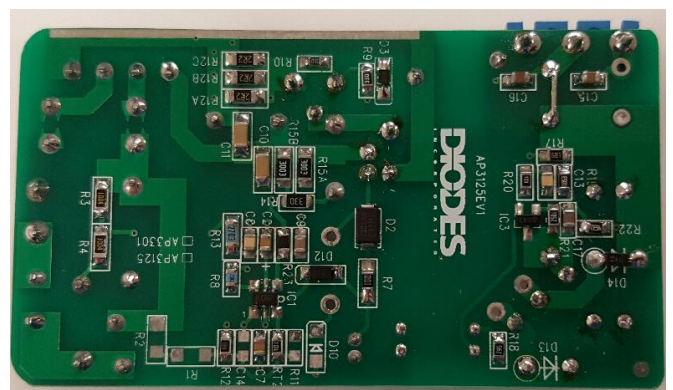
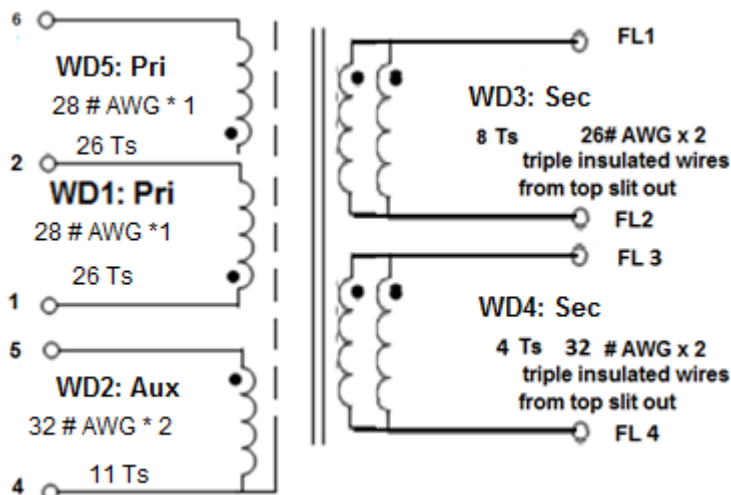

Figure 2: Bottom View

AP3125 (90V_{AC} ~ 230V_{AC} 2 outputs 25W Transformer Spec.)

1) **Core & Bobbin:** RM8, 6+6 pin



2) **Transformer Parameters**

1. Primary Inductance (Pin1-Pin6), all other windings are open
 $L_p = 0.85\text{mH} \pm 5\% @ 1\text{KHz}$

3) **Transformer Winding Construction Diagram**

Item	Windings	Winding Specification
1	WD1-Primary Winding	Start from Pin 1, 28# AWG*1, 26Ts Two layers, end at Pin 2.
2	Insulation	1 Layer of insulation tape
3	Shielding Winding	Start from Pin 4, 34# AWG*2 with full layer winding, end flowing wire.
4	Insulation	1 Layer of insulation tape
5	WD2 Aux Winding	Start from Pin 5, 32# AWG x2, 11TsT one layers, end at Pin 4.
6	Insulation	2 Layers of insulation tape
7	WD3 N _S 1 Secondary Winding	Start from FL1 with white tube, triple of insulation 26# AWG*2, 8Ts, one layer, end fold back to top side with black tube.
8	WD4 N _S 2 Secondary Winding	Start from FL3, triple of insulation 32# AWG*2, 4Ts, one layer, end fold back to top side with FL4 with black tube.
9	Insulation	2 Layers of insulation tape
10	WD5-Primary Winding	Start from Pin 2, 28# AWG*1, 26Ts, Two layers, end at Pin 6.
11	Insulation	2 Layers of insulation tape

Evaluation Board Schematic

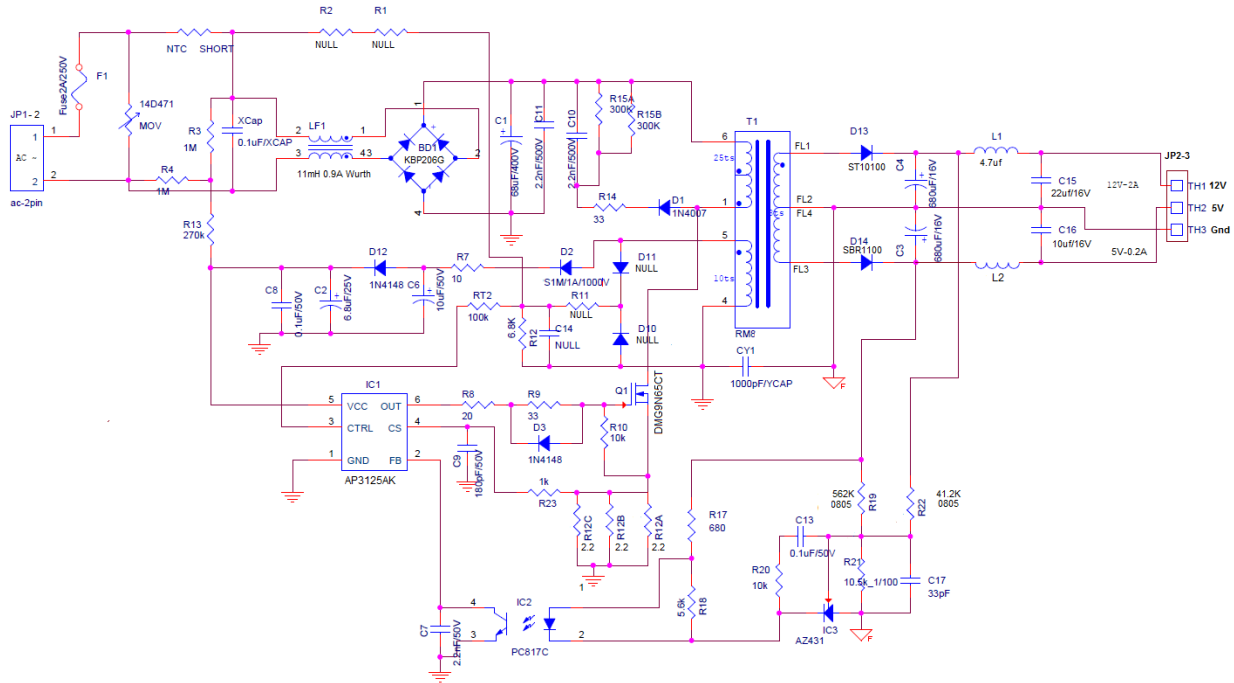

Figure 3: Evaluation Board Schematic

Evaluation Board Layout

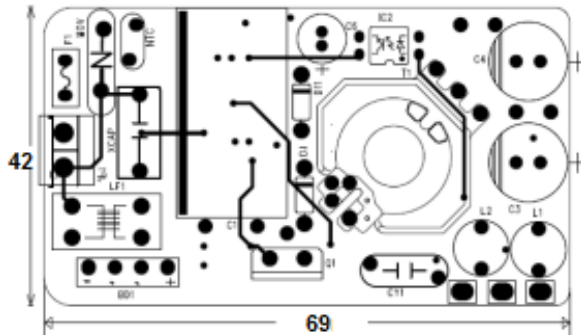

Figure 4: PCB Board Layout Top View

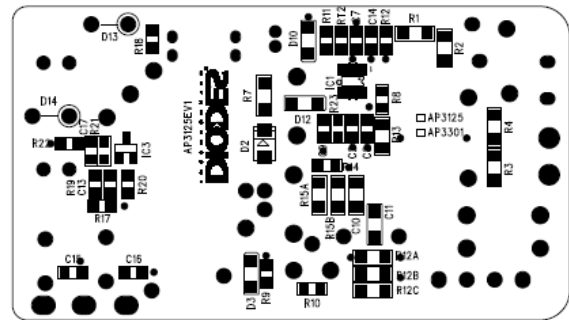

Figure 5: PCB Board Layout Bottom View

Quick Start Guide

1. The evaluation board is preset at 12V/2A from TH1 ~TH3 & 5V/0.2A from TH2~TH3
2. Ensure that the AC source is switched OFF or disconnected.
3. Connect the AC line wires of power supply to "L and N" on the left side of the board.
4. Turn on the AC main switch.
5. Measure TH1~TH3 and TH2~TH3 to ensure correct output voltages at 12V and 5V, respectively.

Universal AC input AP3125A

12V/2A , 5V/0.2A EV1 Board User Guide

Build of Material:

Item	Qty	Reference	AP3125A EV1 08-05-2016	Size	Company
1	1	C1	68μF/400V, AL Cap	16 * 25mm	Wurth
2	1	C2	6.8μF/25V, Ceramic Cap	X7R, ±10%, SMD0805	X7R, ±10%
3	1	C4	680μF/16V, Polymer Cap	10 * 13mm	Wurth
4	1	C3	220μF/16V, AL Cap	8 * 11mm	Wurth
5	1	C6	10μF/50V, AL Cap	5 * 11mm	Wurth
6	1	C7	2.2nF/50V	X7R, ±10%, 0805	Wurth
7	1	C8	0.1μF/50V	X7R, ±10%, 0805	Wurth
8	1	C9	180pF/50V	X7R, ±10%, 0805	Wurth
9	1	C10 & C11	2.2nF/500V	X7R, ±10%, 1206	
10	1	C13	0.1μF/50V	X7R, ±10%, 0805	Wurth
11	1	C14	NULL		
12	1	C15 & C16	10μF/16V, SMDCap	Y5U, ±10%, SMD0805	
13	1	C17	33pF	NPO, ±10%, SMD0805	
14	1	R1 & R2	NULL		
15	1	R3 & R4	1M ohm	SMD 1206	
16	1	R5 & R6	NULL		
17	1	R7	10Ω	±5%, SMD0805	
18	1	R8	20Ω	±5%, SMD0805	
19	1	R9	33Ω	±5%, SMD0805	
20	1	R10	10KΩ	±5%, SMD0603	
21	1	R11	NULL	±5%, SMD0805	
22	1	R12	6.8KΩ	±5%, SMD0805	
23	1	R12A/B/C	2.2Ω / 2.2Ω/ 2.2Ω	±1%, SMD1206	
24	1	R13	270KΩ	±5%, SMD1206	
25	1	R14	33Ω	±5%, SMD1206	
26	2	R15A/B	300KΩ	±5%, SMD1206	
27	1	R17	680Ω	±5%, SMD0805	

28	1	R18	5.6K Ω	\pm 5%, SMD0805	
29	1	R19	562K Ω , 5%	1%, SMD0805	
30	1	R20	10K Ω	\pm 5%, SMD0805	
31	1	R21	10.5K Ω , 1%	\pm 1%, SMD0805	
32	1	R22	41.2K Ω , 1%	\pm 1%, SMD0805	
33	1	RT2	100K Ω	\pm 5%, SMD0805	
34	1	Q1	MOSFET, DMG9N65CT	TO220F	Diodes
35	1	IC1	PWM, AP3125AK,	SOT23-6	Diodes
36	1	IC2	Opto PC817C,	DIP	
37	1	IC3	AZ431, SOT-23	SMD	Diodes
38	1	T1	RM8, 850 μ H		
39	1	BD1	Bridge, KBP206G, 2A-600V	DIP	Diodes
40	1	D1	1N4007, 1A, 1,000V	DIP	Diodes
41	1	D2	S1M, 1A, 1,000V	SMD	Diodes
42	1	D3, D12	1N4148WS, 75V, SOD323	SMD	Diodes
43	1	D13	Schottky, ST10100, TO220-2	DIP	
44	1	D14	SBRB1100 1A, 100V, DOS123	SMD	Diodes
45	1	LF1	11mH 0.9A COM chock	DIP	Würth
46	1	L1 & L2	L1 = 4.7 μ H , L2 shorted	DIP	
47	1	NTC	Shorted		
48	1	CY1	1000pF/Ycap	DIP	250V/Y1
49	1	Xcap	0.1 μ F/Xcap	DIP	275/X1 305Vac
50	1	Mov	14D471	DIP	
51	1	F1	Fuse 2A/250V	DIP	Slow
52	1	JP1	Terminal Block 2P	DIP	
53	2	JP2	Terminal Block 3P	DIP	

Input & Output Characteristics

Input Standby Power

Input Voltage	115Vac/60Hz	230Vac/50Hz	Note
Pin (w)	78mW	154mW	No loading

Input power Efficiency at different loading

AC input	Efficiency (%)					Eff_avg at four conditions
	10%	25%	50%	75%	100%	
90VAC/60Hz					85,2%	
115VAC/60Hz	82.9%	86.9%	87.4%	86.6%	86.5%	86.8%
230VAC/50Hz	78.8%	88.0%	87.1%	87.2%	87.3%	87.4%
264VAC/50Hz					87.5%	
Eff_avg						

Output Characteristics:

Line Regulation (at full loading condition):

AC input Voltage		90VAC/60Hz	115VAC/60Hz	230VAC/50Hz	264VAC/50Hz	Note
outputs	5.00Vo	5.52V/0.2A	5.50V/0.2A	5.52V/0.2A	5.52V/0.2A	0.5%<
	12.00Vo	12.01V/2A	12.01V/2A	12.02V/2A	12.01V/2A	0.5%<

Cross Load Regulation (at nominal line AC input voltage):

Loading conditions	12V= FL & 5V=10%FL	12V=10% FL & 5V= FL
	12V/2A & 5V/0.02A	12V/0.2A & 5V /0.2A
115VAC	12.04V / 2A + 5.708V/0.02A	12.13V/0.2A + 4.94V/0.2A
230VAC	12.04V /2A + 5.714V/0.02A	12.13V/0.2A + 4.94V/0.2A

Current setting with at different AC line

AC input	90VAC	115VAC	230VAC	264VAC	Note
I_max	2.67A	2.69A	2.73A	2.78A	

Note: All output voltages are measured at output PCB board Edge.

Key Performance Waveforms:

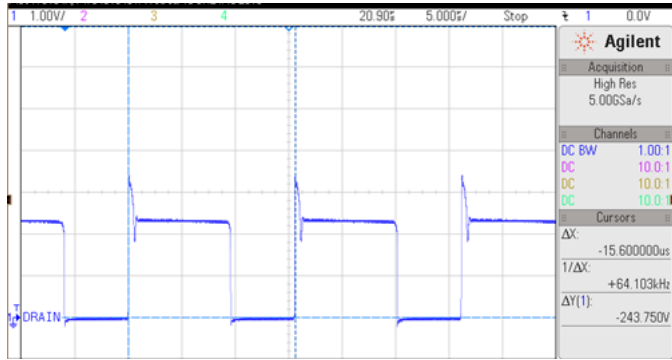

Fig:6 Vds at full load by using DF probe 1:100 at 115V_{AC}

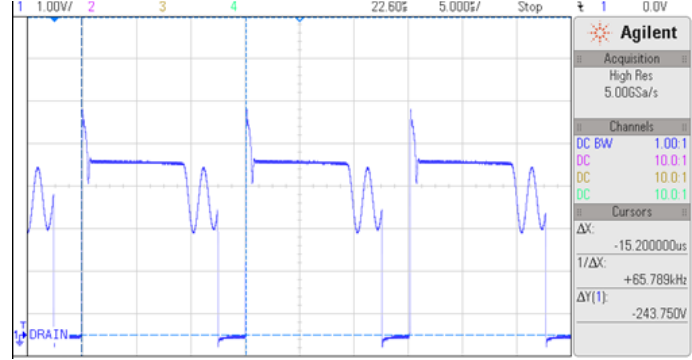

Fig:7 Vds at full load by using DF probe 1:100 at 230V_{AC}

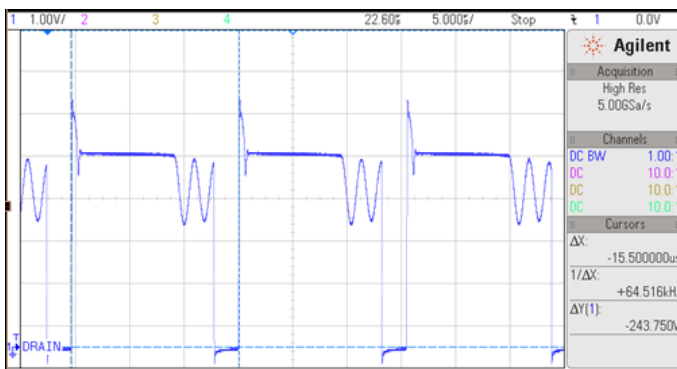

Fig:8 Vds at full load using DF probe 1:100 at 265V_{AC}

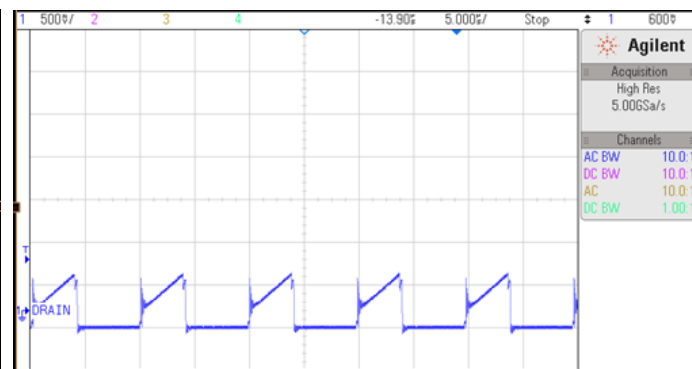

Fig:9 Vcs at 90V_{ACin} at FL

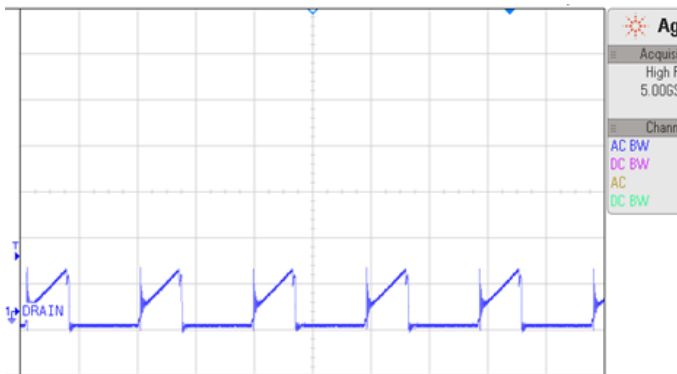

Fig:10 Vcs at 115V_{ACin} at FL

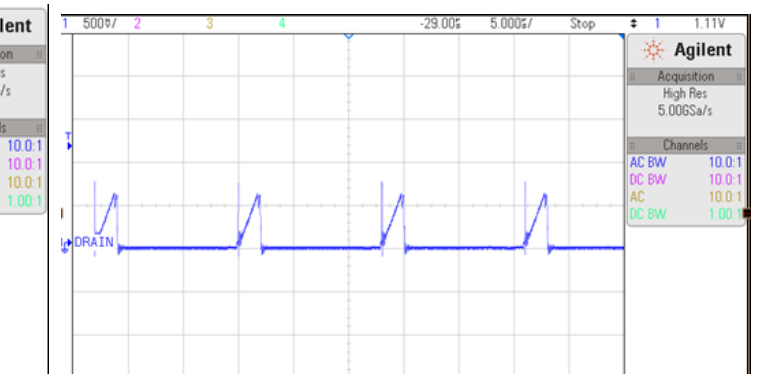

Fig:11 Vcs at 264V_{ACin} at FL

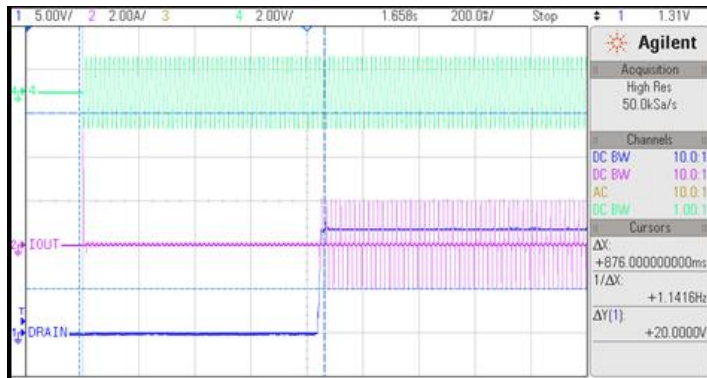

Fig:12 Turn on VAC_in, IAC_in, 12Vo at 115Vac at FL

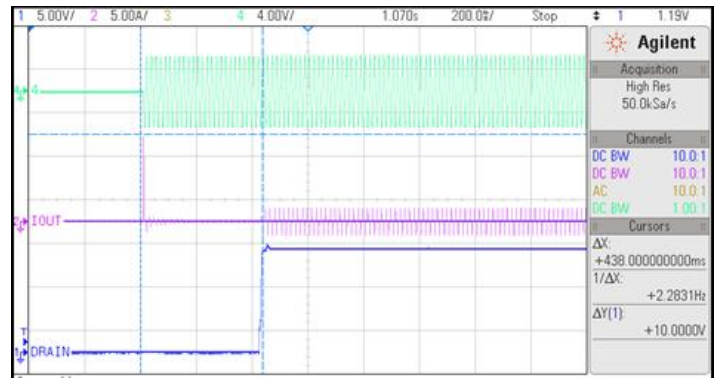

Fig:13 Turn on VAC_in, IAC_in, 12Vo at 230Vac at FL

Output Performance Waveforms

All of the 12V ripple by using a 1:1 Probe in a 100mV/division.

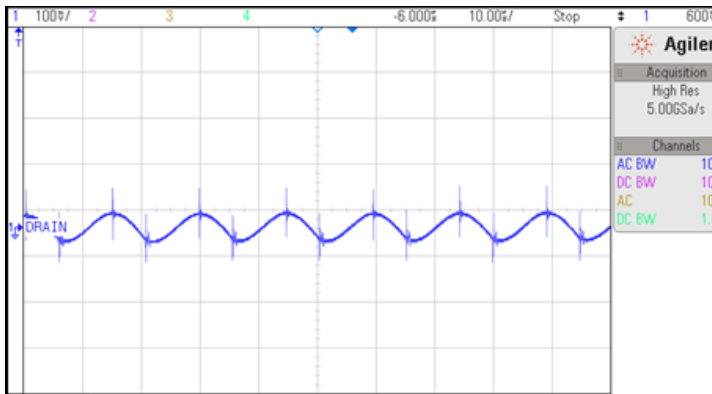

Figure:14 12V Ripple at 115Vac at FL .

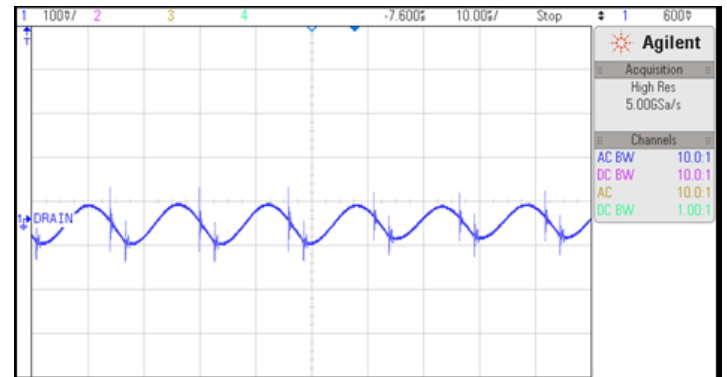

Figure:15 12V Ripple at 230Vac at FL

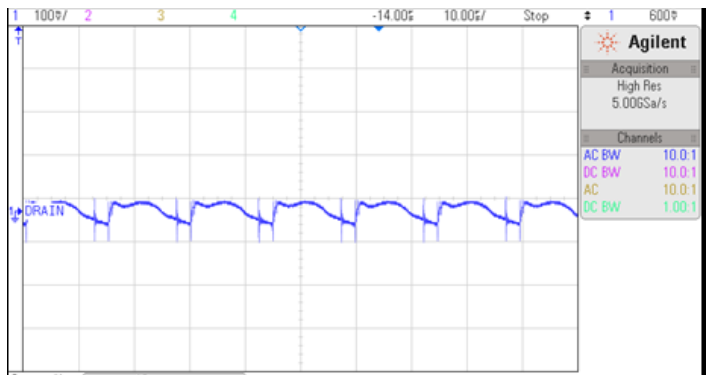

Figure:16 5Vo Ripple at 115Vac at FL

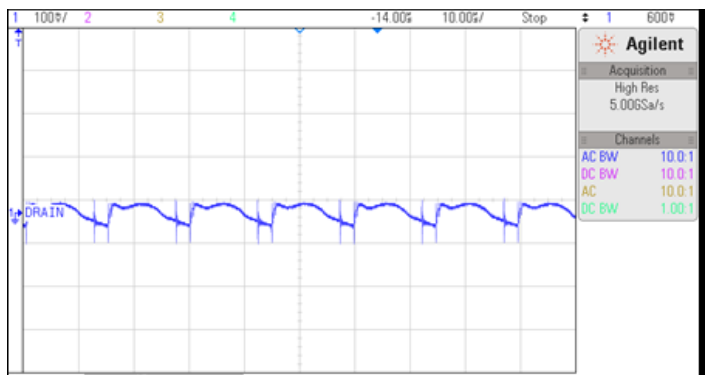

Figure:17 5V Ripple at 230Vac at FL

Please see the recommend Application note for reference (Web page - http://www.diodes.com/appnote_dnote.html)

- 1) For AP3125 operation & set up, please review the Application note:
Application note 1120 Green Mode PWM Controller
- 2) For PSU PCB layout consideration, please review the App note:
AN1062 High Voltage Green Mode PWM Controller AP3105
- 3) For the basic Flyback topology calculation, please review the App note:
AN1045 Design Guidelines for Off-line AC-DC Power Supply Using BCD. PWM Controller AP3103

Thermal Test data at room Temperature after running 1 hr

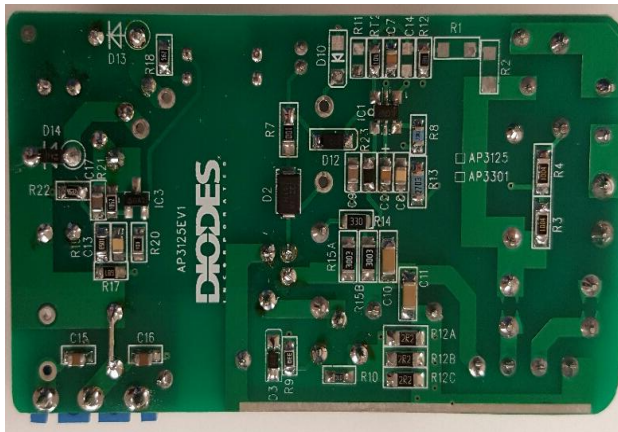

Figure:18 SMD components UP side

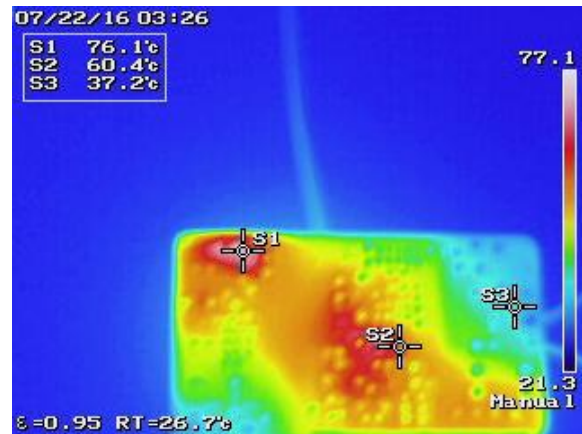

Figure:19 SMD side Vin=115V_{AC}, Test time=1hour

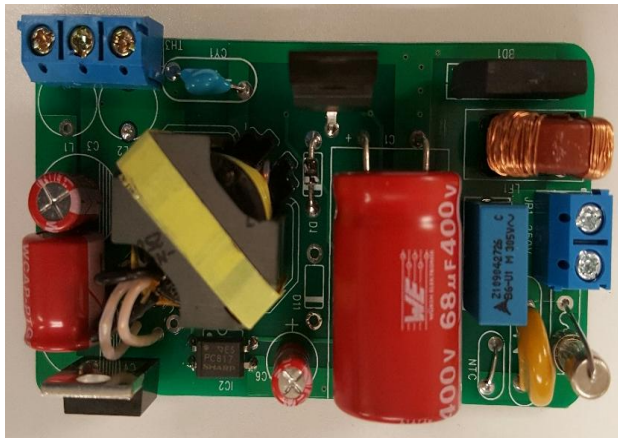

Figure:20 Board Top components side

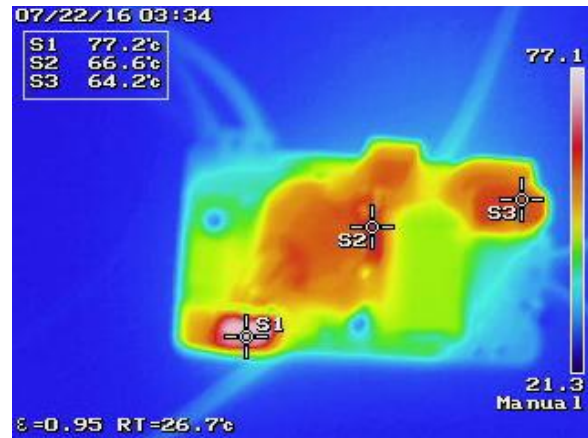

Figure:21 Vin=115V_{AC}, Testing time = 1.15 hour

IMPORTANT NOTICE

DIODES INCORPORATED MAKES NO WARRANTY OF ANY KIND, EXPRESS OR IMPLIED, WITH REGARDS TO THIS DOCUMENT, INCLUDING, BUT NOT LIMITED TO, THE IMPLIED WARRANTIES OF MERCHANTABILITY AND FITNESS FOR A PARTICULAR PURPOSE (AND THEIR EQUIVALENTS UNDER THE LAWS OF ANY JURISDICTION).

Diodes Incorporated and its subsidiaries reserve the right to make modifications, enhancements, improvements, corrections or other changes without further notice to this document and any product described herein. Diodes Incorporated does not assume any liability arising out of the application or use of this document or any product described herein; neither does Diodes Incorporated convey any license under its patent or trademark rights, nor the rights of others. Any Customer or user of this document or products described herein in such applications shall assume all risks of such use and will agree to hold Diodes Incorporated and all the companies whose products are represented on Diodes Incorporated website, harmless against all damages.

Diodes Incorporated does not warrant or accept any liability whatsoever in respect of any products purchased through unauthorized sales channel.

Should Customers purchase or use Diodes Incorporated products for any unintended or unauthorized application, Customers shall indemnify and hold Diodes Incorporated and its representatives harmless against all claims, damages, expenses, and attorney fees arising out of, directly or indirectly, any claim of personal injury or death associated with such unintended or unauthorized application.

Products described herein may be covered by one or more United States, international or foreign patents pending. Product names and markings noted herein may also be covered by one or more United States, international or foreign trademarks.

This document is written in English but may be translated into multiple languages for reference. Only the English version of this document is the final and determinative format released by Diodes Incorporated.

LIFE SUPPORT

Diodes Incorporated products are specifically not authorized for use as critical components in life support devices or systems without the express written approval of the Chief Executive Officer of Diodes Incorporated. As used herein:

A. Life support devices or systems are devices or systems which:

1. are intended to implant into the body, or
2. support or sustain life and whose failure to perform when properly used in accordance with instructions for use provided in the labeling can be reasonably expected to result in significant injury to the user.

B. A critical component is any component in a life support device or system whose failure to perform can be reasonably expected to cause the failure of the life support device or to affect its safety or effectiveness.

Customers represent that they have all necessary expertise in the safety and regulatory ramifications of their life support devices or systems, and acknowledge and agree that they are solely responsible for all legal, regulatory and safety-related requirements concerning their products and any use of Diodes Incorporated products in such safety-critical, life support devices or systems, notwithstanding any devices- or systems-related information or support that may be provided by Diodes Incorporated. Further, Customers must fully indemnify Diodes Incorporated and its representatives against any damages arising out of the use of Diodes Incorporated products in such safety-critical, life support devices or systems.

Copyright © 2016, Diodes Incorporated

www.diodes.com