

## Pericom PCIe ReDriver/Repeater Compatibility in a GEN3 Channel

### 1. PCIE 3.0 Channel insertion loss

The Reference channel Insertion loss is defined from TP1 to TP2  
 20 dB Long channel plus breakout channel  
 12dB Short channel plus breakout channel  
 2.5dB Breakout channel only

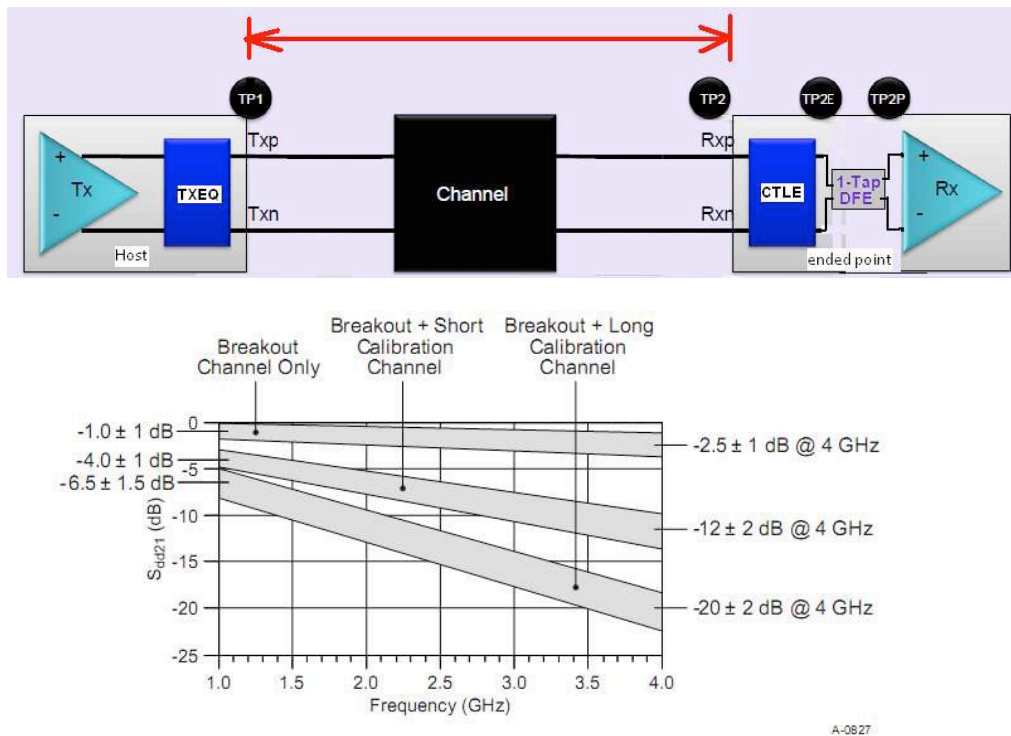

### 2. Benefit PI2EQX8908/8984

EQX8908/8984 EQ DE can hand about 16 dB loss at both Input and Output side. It can extend PCIe 3.0 total channel loss up to 32dB.

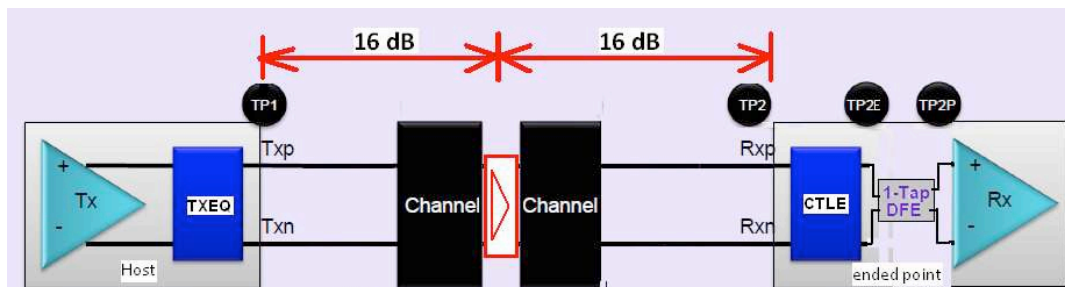

PI2EQX8908/8984 is equivalent part of channel. It does not block any protocol communication during the link training. Please see chapter 5~7 for detail.

### 3. PCIE 3.0 TX EQ

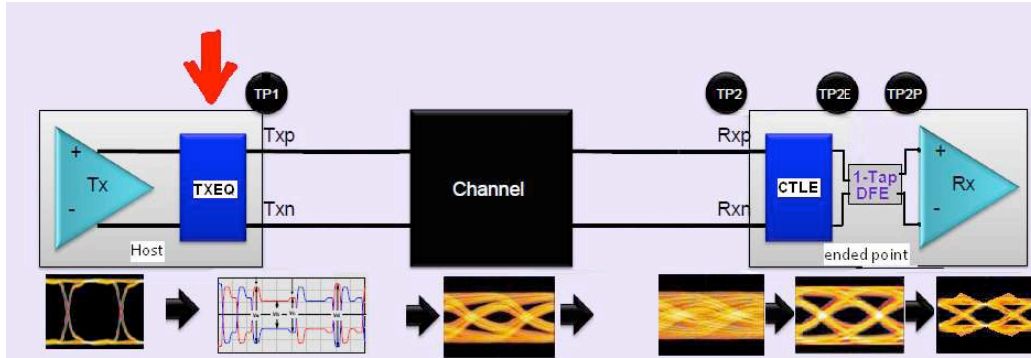

- TXEQ is definition 11 TX presets
  - Modeled with the 11 TX presets  
TX EQ is 3-tap FIR, adjust FIR coefficients to implementing pre-shoot and de-emphasis
  - Coefficient tuning: 1/24 resolution,  $C-1 \leq 0.167$ ,  $C+1 \leq 0.333$

Preset Number	preshoot (dB)	de-emph (dB)	$c_{-1}$	$c_{+1}$	Va/Vd	Vb/Vd	Vc/Vd
P4	0.0	0.0	0.000	0.000	1.000	1.000	1.000
P1	0.0	-3.5 ±1 dB	0.000	-0.167	1.000	0.668	0.668
P0	0.0	-6.0 ±1.5 dB	0.000	-0.250	1.000	0.500	0.500
P9	3.5 ±1 dB	0.0	-0.166	0.000	0.668	0.668	1.000
P8	3.5 ±1 dB	-3.5 ±1 dB	-0.125	-0.125	0.750	0.500	0.750
P7	3.5 ±1 dB	-6.0 ±1.5 dB	-0.100	-0.200	0.800	0.400	0.600
P5	1.9 ±1 dB	0.0	-0.100	0.000	0.800	0.800	1.000
P6	2.5 ±1 dB	0.0	-0.125	0.000	0.750	0.750	1.000
P3	0.0	-2.5 ±1 dB	0.000	-0.125	1.000	0.750	0.750
P2	0.0	-4.4 ±1.5 dB	0.000	-0.200	1.000	0.600	0.600
P10	0.0	Note 2	0.000	Note 2	1.000	Note 2	Note 2

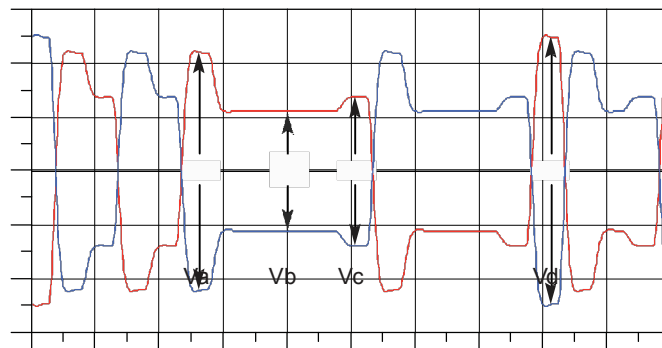

De-emphasis =  $20\log_{10} Vb/Va$  Preshoot =  $20\log_{10} Vc/Vb$  Boost =  $20\log_{10} Vd/Vb$

#### 4. PCIE 3.0 RX EQ

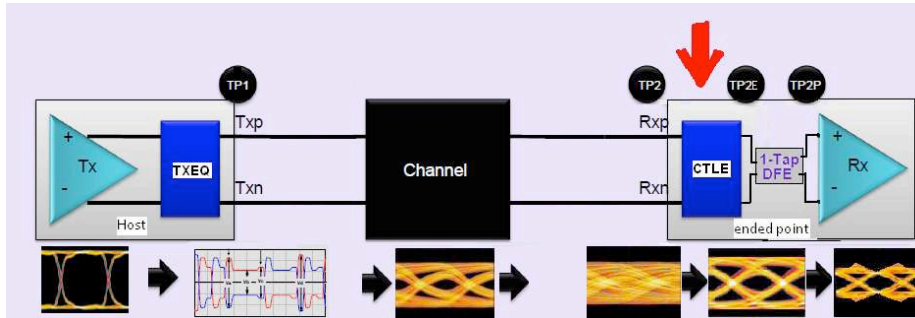

**RX EQ is including 1st order CTLE and 1-tap DFE**

- 2.5dB Breakout channel only – Rx CTLE
- 12dB Short channel plus breakout channel – Rx CTLE
- 20 dB Long channel plus breakout channel – with Rx CTLE and DFE

**RX CTLE is HPF/LPF with fixed poles and AD/DC gain from -6 to -12 dB in 1.0 dB steps**

It provides high frequency boost to cancel the ISI (Inter-symbol interference) generated by the Channel loss.

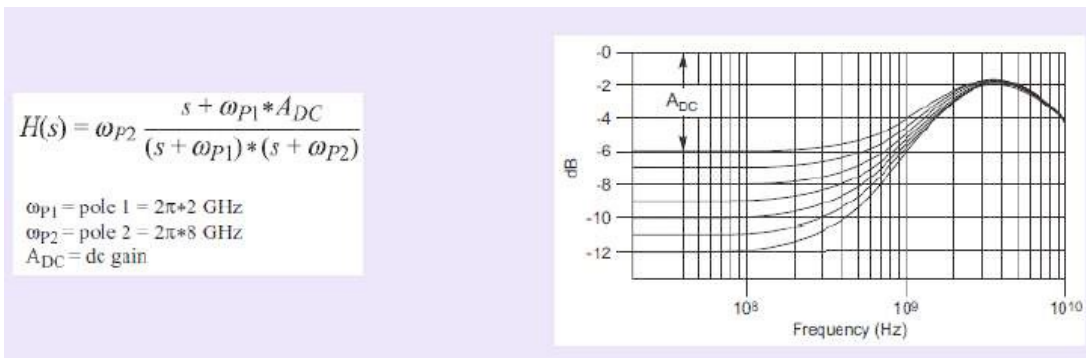

AC vs. DC Gain Curves

#### RX CTLE +DFE

Analysis of long channels has shown that a combination of TXEQ, RX CTLE and 1-tap Rx DFE is required to yield practical eye margins.

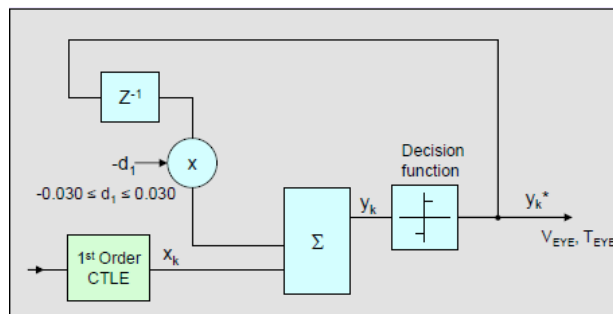

CTLE= Continuous Time Linear Equalizer  
DFE= Decision Feedback Equalizer

## 5. PCIe3.0 TXEQ and CTLE Training process

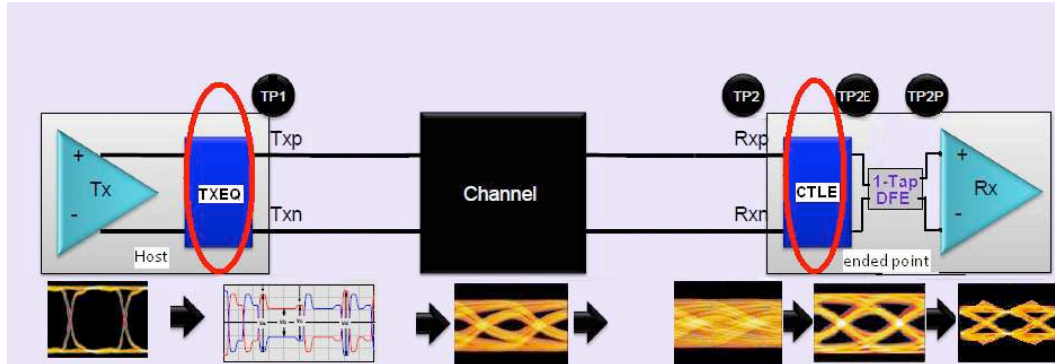

- 1) The training process is to find out “best fit” setting of both TX EQ and RX CTLE. The “best fit” setting can achieve best BER performance (maximizing eye height x eye width).
- 2) During training, the receiver evaluates 7 possible CTLE settings. Also the receiver can request transmitter adjusts the TX EQ FIR coefficients by sending commands on backward channel.
- 3) All possible equalizer settings will evaluate. There are 11 possible TX presets at each CTLE step. There are total possible 77 training steps (7x11=77 steps).
- 4) **After training, both “TX” and “RX” automatic choose successful trained EQ setting (the receive BER <- 12) for final link work.**

Preset Number	preshoot (dB)	de-emph (dB)	$c_{-1}$	$c_{+1}$
P4	0.0	0.0	0.000	0.000
P1	0.0	-3.5 ±1 dB	0.000	-0.167
P0	0.0	-6.0 ±1.5 dB	0.000	-0.250
P9	3.5 ±1 dB	0.0	-0.166	0.000
P8	3.5 ±1 dB	-3.5 ±1 dB	-0.125	-0.125
P7	3.5 ±1 dB	-6.0 ±1.5 dB	-0.100	-0.200
P5	1.9 ±1 dB	0.0	-0.100	0.000
P6	2.5 ±1 dB	0.0	-0.125	0.000
P3	0.0	-2.5 ±1 dB	0.000	-0.125
P2	0.0	-4.4 ±1.5 dB	0.000	-0.200
P10	0.0	Note 2	0.000	Note 2

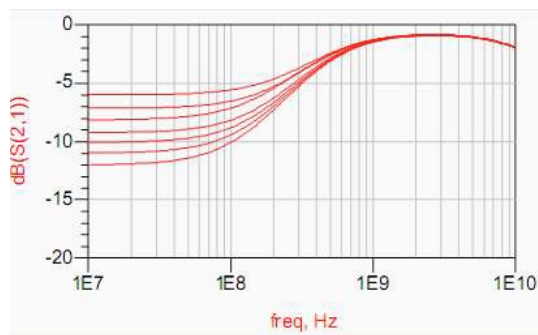

Training step	HOST TXEQ Preset No.	End point RX CTLE
1	TXEQ=P0	CTLE = -6 dB
2	TXEQ=P1	
3	TXEQ=P2	
4	TXEQ=P3	
5	TXEQ=P4	
6	TXEQ=P5	
7	TXEQ=P6	
8	TXEQ=P7	
9	TXEQ=P8	
10	TXEQ=P9	
11	TXEQ=P10	
12	TXEQ=P0	CTLE = -7 dB
13	TXEQ=P1	
14	TXEQ=P2	
15	TXEQ=P3	
16	TXEQ=P4	
17	TXEQ=P5	
18	TXEQ=P6	
19	TXEQ=P7	
20	TXEQ=P8	
21	TXEQ=P9	
22	TXEQ=P10	
.....	.....	.....
56	TXEQ=P0	CTLE = -11 dB
57	TXEQ=P1	
.....	TXEQ=P9	
65	TXEQ=P10	CTLE = -12 dB
67	TXEQ=P0	
68	TXEQ=P1	
.....	TXEQ=P9	
76	TXEQ=P10	
77		

## 6. PI2EQX8908/8984 during PCIE3.0 training

The example channel condition: Total channel loss 26dB. EQX8908/8984 break loss channel in two segments (13+13dB), the EQX8908/8984 EQ=12.6dB, Pre-emph 3dB.

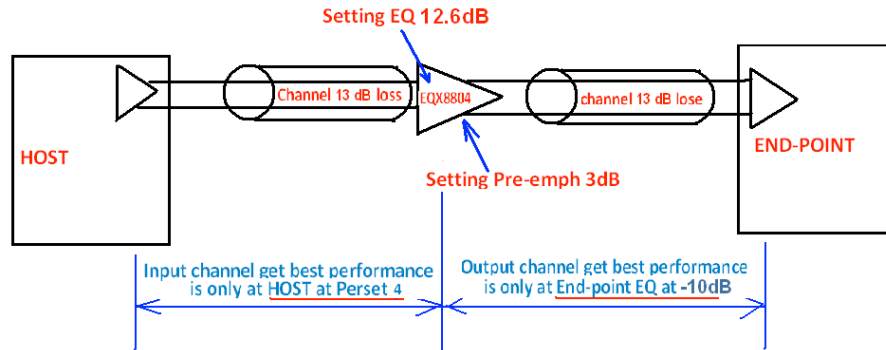

### Link Training process:

- 1) During downstream training, the RX evaluates 7 possible CTLE steps. Also the RX requests adjust TX EQ setting by sending command on backward channel. There are 11 possible TX presets at each CTLE step. Total possible training setting is 77 steps (7x11=77 steps).
- 2) The EQX8908/8984 break 26dB loss channel in two segments (13dB+13dB). First segment channel is the "input channel" (HOST→EQX8908/8984), the second is "output channel" (EQX8908/8984 → End-point).
- 3) The "best fit" setting requires both segments get best BER performance.
  - The "input channel (HOST → EQX8908/8984)" gets best BER is at TX output "Preset 4". Because the EQX8908/8984 EQ 12.6dB is compensated the channel loss 13dB. It just gets the best eye opening at "Preset 4" 0dB De-emph (compensation err 13dB-12.6dB=0.4dB).
  - The "output channel (EQX8908/8984 → End-point)" gets best BER is at "End point" CTLE EQ adjusted to -10 dB. The reason is End-point CTLE = -10dB just compensation the channel 13dB loss when EQX8908/8984 out 3dB pre-emph. The CTLE -11 dB will over EQ, and
    - 1) 9dB will less EQ.
- 4) After the HOST/End-point trying all of 77 steps, it automatic pick up the best BER setting. The best BER is the training step=49 for this case.

Training step	HOST TXEQ Preset No.	End point RX CTLE
1	TXEQ=P0	CTLE = -6 dB
2	TXEQ=P1	
.....	TXEQ=P9	
10	TXEQ=P10	
.....	.....	
45	TXEQ=P0	CTLE = -10 dB
46	TXEQ=P1	
47	TXEQ=P2	
48	TXEQ=P3	
49	TXEQ=P4	
.....	.....	.....
67	TXEQ=P0	CTLE = -12 dB
68	TXEQ=P1	
.....	TXEQ=P8	
75	TXEQ=P9	
76	TXEQ=P10	
77		

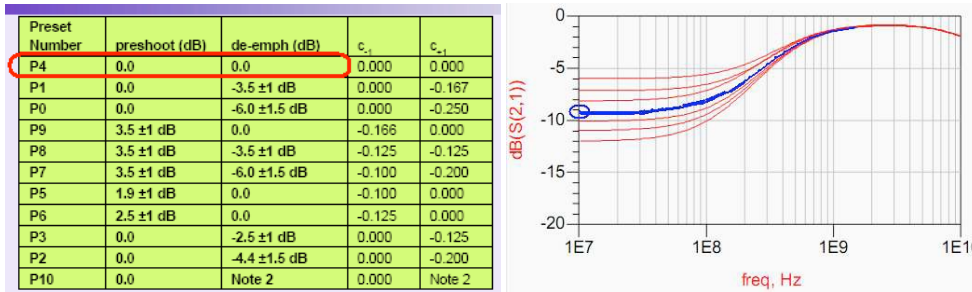

## 7. PI2EQX8908/8984 at channel variety

The example condition: Keep the same (same chapter 6) setting EQX8908/84 EQ=12.6dB, Pre-emph 3dB.  
 Input Channel loss change from 13dB to 16dB(or+13dB) Output  
 Channel loss from change 13dB to 10dB (or-3dB)

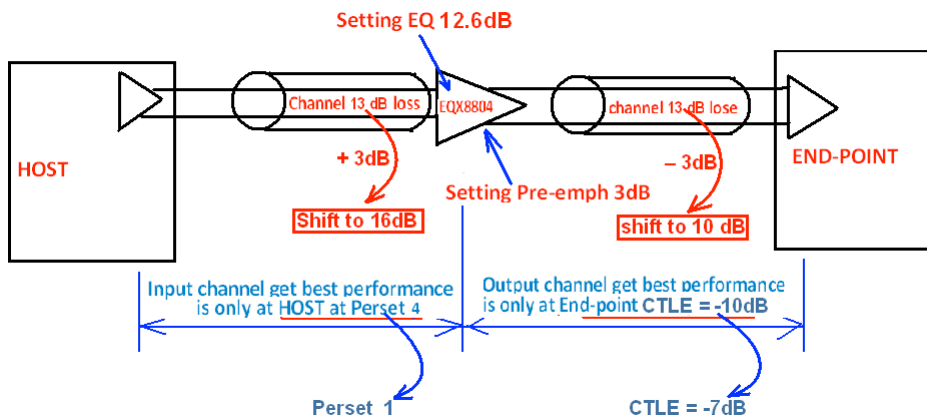

The “input channel (HOST to EQX8908/8984)” gets best eye opening is at TX output “Preset 1”. Because the EQX8908/8984 EQ 12.6dB is just compensation the channel loss 16dB when TX with De-emph -3.5dB (compensation err 16dB-12.6dB-3.5dB=- 0.1dB).

The “output channel (EQX8908/8984 to End-point)” eye opening is at RX CTLE adjustment to -7 dB. Because only CTLE = -7dB just compensation the channel loss 10dB when TX with 3.0dB pre-emph (compensation err 10dB-7dB-3.0dB=0.0dB).

After the HOST/End-point trying all of 77 training steps, it automatic pick up the best BER training step=13 for final work.



	HOST TXEQ Preset No.	End point RX CTLE
1	TXEQ=P0	CTLE = -6 dB
2	TXEQ=P1	
.....	TXEQ=P9	
10	TXEQ=P10	
12	TXEQ=P0	CTLE = -7 dB
13	TXEQ=P1	
.....	TXEQ=P9	
21	TXEQ=P10	
.....	.....	.....
45	TXEQ=P0	CTLE = -10 dB
.....	TXEQ=P2	
48	TXEQ=P3	
49	TXEQ=P4	
.....	.....	
.....	.....	.....
67	TXEQ=P0	CTLE = -12 dB
68	TXEQ=P1	
69	TXEQ=P2	
.....	TXEQ=P8	
75	TXEQ=P9	
76	TXEQ=P10	

Preset Number	preshoot (dB)	de-emph (dB)	c	c
P4	0.0	0.0	0.000	0.000
P1	0.0	-3.5 !:1dB	0.000	.0.167
eu	u.u	b.U + oo, 01>	u.wu	tUOU
P9	3.5:t1dB	0.0	-0.166	0.000
P8	3.5:!1dB	-3.5 !:1dB	.() 125	-0.125
P7	3.5+1dB	-6.0 +1.5 dB	.().100	.0.200
P5	1.9 +1dB	0.0	.().100	0.000
P6	2.5 ±1dB	0.0	.0.125	0.000
P3	0.0	-2.5 ±1 dB	0.000	.0.125
P2	0.0	-4.4 ±1.5 dB	0.000	.0.200
P10	0.0	Note 2	0.000	Note 2

## 8. Pericom Products

- **PI3EQX8908** – PCIe1.0/2.0/3.0, 8-Channel ReDriver/Repeater Flow Through Pinout
- **PI3EQX8984** – PCIe 1.0/2.0/3.0, 4-Lane/8-Channel- Interleave Pinout ReDriver /Repeater

Contact [Pericom Sales](#) for more information